

## Excellent Integrated System Limited

Stocking Distributor

Click to view price, real time Inventory, Delivery & Lifecycle Information:

[Molex Connector Corporation](#)  
[0442820008](#)

For any questions, you can email us directly:

[sales@integrated-circuit.com](mailto:sales@integrated-circuit.com)

NOTES:

- 1) MATERIAL: HOUSING & INSULATOR: NYLON(PA), GLASS FILLED, UL94V-0, COLOR: BLACK  
TERMINALS: PHOSPHOR BRONZE, .012/(0.30) THICK  
SHIELD: BRASS
- 2) FINISH: TERMINALS:  
A = SELECT GOLD IN CONTACT AREA: .000050/(0.00127) MIN.,  
\*SELECT MATTE TIN IN PC TAIL AREA: .000100/(0.00254) MIN.,  
WITH OVERALL NICKEL UNDERPLATE: .000050/(0.00127) MIN.  
B = SELECT GOLD IN CONTACT AREA: .000030/(0.00076) MIN.,  
\*SELECT MATTE TIN IN PC TAIL AREA: .000100/(0.00254) MIN.,  
WITH OVERALL NICKEL UNDERPLATE: .000050/(0.00127) MIN.  
C = SELECT GOLD IN CONTACT AREA: .000015/(0.00038) MIN.,  
\*SELECT MATTE TIN IN PC TAIL AREA: .000100/(0.00254) MIN.,  
WITH OVERALL NICKEL UNDERPLATE: .000050/(0.00127) MIN.  
SHIELD:  
\*100 MICRONS NICKEL OVER 50 MICRONS COPPER UNDERPLATE  
PCB GROUND TABS DIPPED IN TIN  
\*THE PRIMARY SHIPPING CARTON WILL BE LABELED "COMPLIANT TO RoHS  
DIRECTIVE 2002/95/EC AND ELV ANNEX II OF DIRECTIVE 2000/53/EC".  
CARTONS WITHOUT THIS LABEL MAY CONTAIN PRODUCT WITH TIN-LEAD  
IN THE PC TAILS AND/OR SHIELD.
- 3) PRODUCT SPECIFICATION AND PROCESSING PARAMETERS: PS-43743-0001.
- 4) PACKAGING SPECIFICATION: CONNECTOR ASSEMBLIES TO BE PACKAGED USING TAPE & REEL SYSTEM  
PER PACKAGING DRAWING PK-70873-7006.
- COPLANARITY SPECIFICATION:  
WHEN AN ASSEMBLY IS PLACED UPON A LEVEL SURFACE, THE MAXIMUM  
GAP BETWEEN THE LEVEL SURFACE AND ALL TERMINAL TAILS AND  
FRONT SOLDER TAB IS .006/(0.15).
- THRU HOLES .094±.002/(2.39±0.05) ARE FOR SHIELDS WITH LOCATION TABS ONLY.  
AVAILABLE WITH (4) OPTIONAL SIDE GROUND TABS (OMITTED FOR SIDE TO SIDE  
STACKABILITY).
- AVAILABLE WITH (2) OPTIONAL LOCATION TABS FOR LOCATING COMPONENT  
TO PCB AND/OR GROUNDING TO PCB.
- FOR ASSEMBLIES HAVING VOIDED CIRCUITS, THE TAIL PORTION IS CUT  
AND REMOVED. THE MATING PORTION OF THE TERMINAL REMAINS INTACT.
- CONFORMS TO FCC REGULATION PART 68.5 FOR MODULAR JACKS.
- THIS PART CONFORMS TO CLASS B REQUIREMENTS OF COSMETIC  
SPECIFICATION PS-45499-002.

OPTIONAL TOP GROUND TABS  
(SEE CHART)

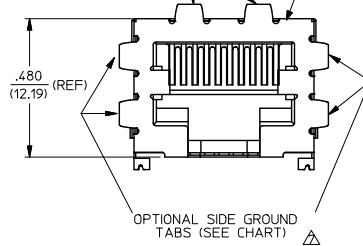

SHIELDED SMT  
MODJACK ASSEMBLY

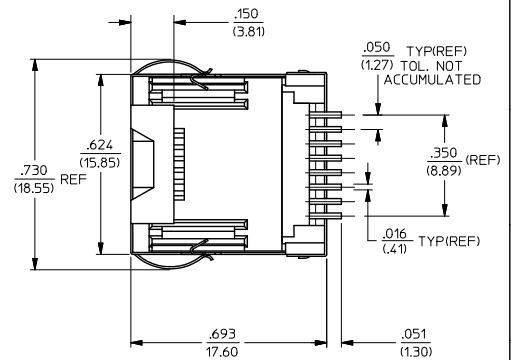
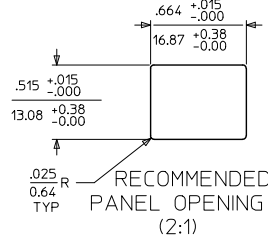
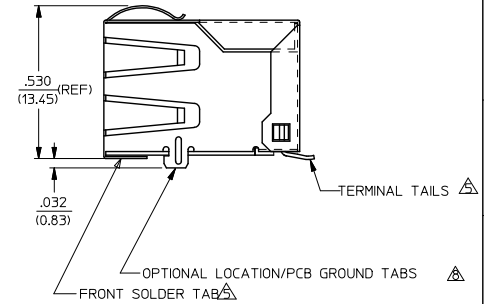

44282-1004	A	NO	NO	YES	NONE
44282-0012	C	NO	YES	NO	NONE
44282-0011	B	NO	YES	NO	NONE
44282-0010	A	NO	YES	NO	NONE
44282-0009	C	YES	YES	NO	NONE
44282-0008	B	YES	YES	NO	NONE
44282-0007	A	YES	YES	NO	NONE
44282-0006	C	NO	YES	YES	NONE
44282-0005	B	NO	YES	YES	NONE
44282-0004	A	NO	YES	YES	NONE
44282-0003	C	YES	YES	YES	NONE
44282-0002	B	YES	YES	YES	NONE
44282-0001	A	YES	YES	YES	NONE

44282-0001, 44282-0002  
& 44282-0003 SHOWN

ASSEMBLY MAT. NO.	TERMINAL PLATING	SHIELD SIDE TABS	SHIELD TOP TABS	LOCATION TABS	VOIDED CIRCUITS
12					
11					
10					
9					
8					
7					
6					
5					
4					
3					
2					
1					

ib\_frame\_C\_P\_ME\_T  
Rev. E 2006/04/15

<b>REVISED NOTES</b> REC NO: UCP2009-1244 DRAWN: JACUSTE/ELE/2008/12/10 CHKD: J.BELL APPR: S.MITH 2008/12/10	<b>QUALITY SYMBOLS</b> ▽=0 ▽=0	GENERAL TOLERANCES (UNLESS SPECIFIED) mm INCH		DIMENSION STYLE IN/MM		SCALE 1:1	DESIGN UNITS INCH	THIRD ANGLE PROJECTION		
		4 PLACES ± --- ± --- 3 PLACES ± --- ± .010 2 PLACES ± 0.25 ± --- 1 PLACE ± --- ± ---	DRAWN BY STAMBAUG	DATE 99/06/03	TITLE SINGLE PORT, SHIELDED SIZE 8, 8 CIRCUIT SMT MODJACK		MOLEX INCORPORATED		SHEET NO. 1 OF 2	
		ANGULAR ± 1/2°	CHECKED BY WIRKUS	DATE 99/06/03	MATERIAL NO. SEE CHART		DOCUMENT NO. SD-44282-001		THIS DRAWING CONTAINS INFORMATION THAT IS PROPRIETARY TO MOLEX INCORPORATED AND SHOULD NOT BE USED WITHOUT WRITTEN PERMISSION	

2	D2
1	D3
SHT	REV

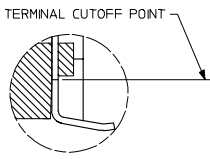

VIEW SHOWING TYPICAL TERMINAL CUTOFF OF TAIL (SEE NOTE 10) FOR VOIDED CIRCUITS.

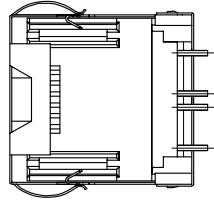

TYPICAL VIEW SHOWING VOIDED CIRCUIT (CIRCUITS 2,3,6 & 7 SHOWN VOIDED)

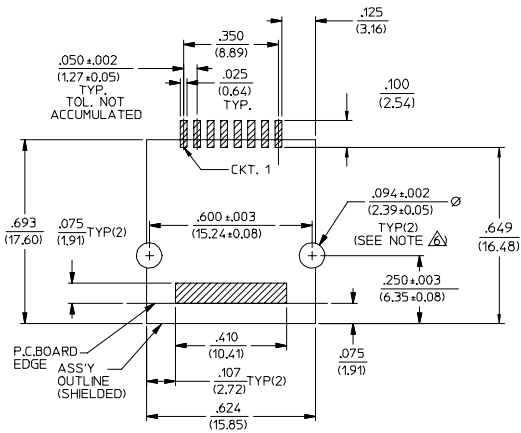

PC BOARD LAYOUT FOR 8 POSITION HOUSING  
(COMPONENT SIDE OF BOARD)

NOTES:  
1. RECOMMENDED MINIMUM PCB THICKNESS: .034/0.86

SEE SHEET ONE I.C. NO: UCF2008-0143 DRAWN BY: JRELL 2007/07/24 CHECKED BY: CHIKOLSKYI DT 2007/07/30 APPROVED BY: TH 2007/08/14	QUALITY SYMBOLS	GENERAL TOLERANCES (UNLESS SPECIFIED)	DIMENSION STYLE IN/MM	SCALE 4:1	DESIGN UNITS INCH	THIRD ANGLE PROJECTION
	▽=0	4 PLACES ± .010 ± .010	DRAWN BY DATE STAMBAUG 99/06/03	TITLE SURFACE MOUNT MODULAR JACK W/ SHIELD		
	▽=0	3 PLACES ± .010 ± .010	CHECKED BY DATE WIRKUS 99/06/03			
		2 PLACES ± 0.25 ± .010	APPROVED BY DATE EDGLEY 99/06/03	MATERIAL NO. MOLEX INCORPORATED		
	1 PLACE ± .010 ± .010	ANGULAR ± 1/2°	SEE CHART	DOCUMENT NO. SD-44282-001	SHEET NO. 2 OF 2	
DRAFT WHERE APPLICABLE MUST REMAIN WITHIN DIMENSIONS		THIS DRAWING CONTAINS INFORMATION THAT IS PROPRIETARY TO MOLEX INCORPORATED AND SHOULD NOT BE USED WITHOUT WRITTEN PERMISSION				