

Excellent Integrated System Limited

Stocking Distributor

Click to view price, real time Inventory, Delivery & Lifecycle Information:

[Molex Connector Corporation](#)
[0474170001](#)

For any questions, you can email us directly:

sales@integrated-circuit.com

47417

ASS. P/N	CKTS	A	B
47417-1001	2	4.10	2.00
47417-2001	3	6.10	4.00
47417-0001	4	8.10	6.00

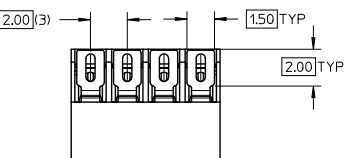
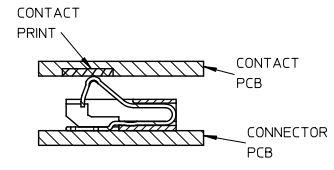
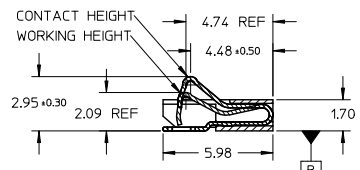
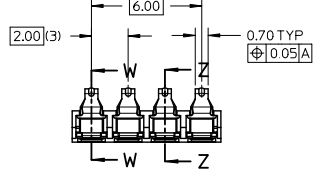
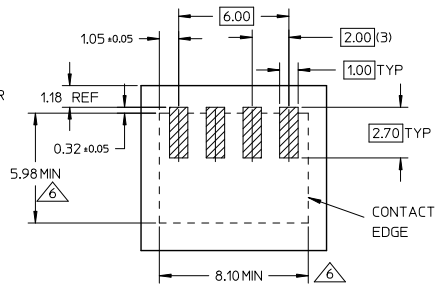
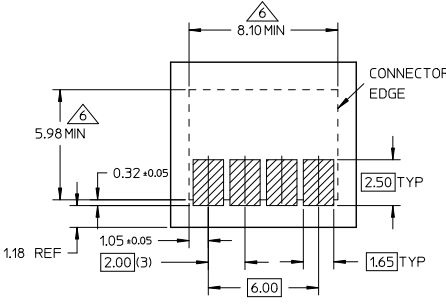
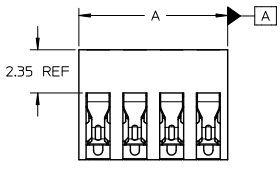

SECTION Z-Z

SECTION W-W

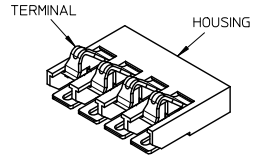

- NOTE:
- MATERIAL:
HOUSING: HIGH TEMPERATURE THERMOPLASTIC, COLOR :BLACK
TERMINAL: COPPER ALLOY.
 - FINISH:
CONTACT AREA: 0.75 MICRON GOLD MIN OVER 1.25 MICRON NICKEL MIN.
SOLDER AREA: GOLD FLASH (0.075-0.125 MICRON) OVER 1.25 MICRON NICKEL
MIN. REST AREA: 1.25 MICRON NICKEL MIN.
 - COPLANARITY: 0.1 MAX AMONG THESE SOLDER TAILS.
 - PRODUCT SPECIFICATION: PS-47182-001
 - WORKING HEIGHT: 2.10mm REF.
 - CONNECTOR KEEP-OUT ZONE

DRAWING UPDATE EC NO: S2012-073 DRW: LK CHEW 2011/09/16 CHKD: 2011/10/27 APPR: SHONG 2011/10/27	QUALITY SYMBOLS ▽ - 0 ▽ - 0	GENERAL TOLERANCES (UNLESS SPECIFIED)		SCALE 5:1	DESIGN UNITS METRIC	THIRD ANGLE PROJECTION	REVISE ON CAD ONLY
		DIMENSION STYLE MM ONLY		DRAWN BY LSHEN DATE 2006/02/18	CHECKED BY XU XIANG DATE 2006/04/06	TITLE 2.0MM PITCH 4 CIRCUITS 0.7MM CONTACT WIDTH BATTERY CONNECTOR	
DRAFT WHERE APPLICABLE MUST REMAIN WITHIN DIMENSIONS		ANGULAR ± 2 °		APPROVED BY JENNY DATE 2006/04/14	MATERIAL NO. SEE TABLE	DOCUMENT NO. SD-47417-001	SHEET NO. 1 OF 1
THIS DRAWING CONTAINS INFORMATION THAT IS PROPRIETARY TO MOLEX INCORPORATED AND SHOULD NOT BE USED WITHOUT WRITTEN PERMISSION							