

Excellent Integrated System Limited

Stocking Distributor

Click to view price, real time Inventory, Delivery & Lifecycle Information:

[Molex Connector Corporation](#)
[0511631100](#)

For any questions, you can email us directly:

sales@integrated-circuit.com

10 9 8 7 6 5 4 3 2 1

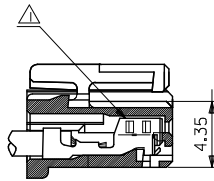
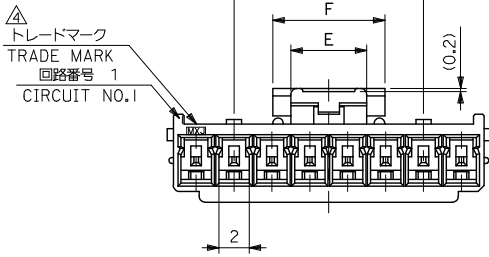

ターミナル装着状態図
TERMINAL ASSEMBLY DRAWING

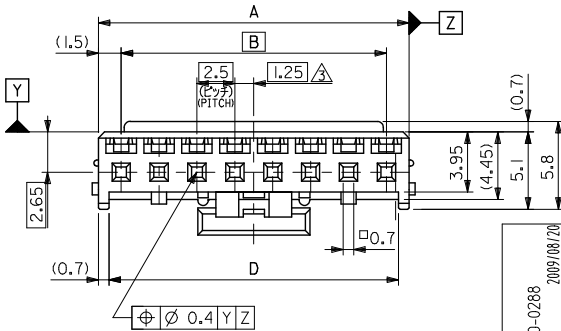
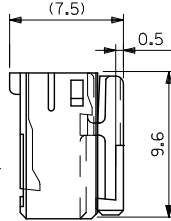
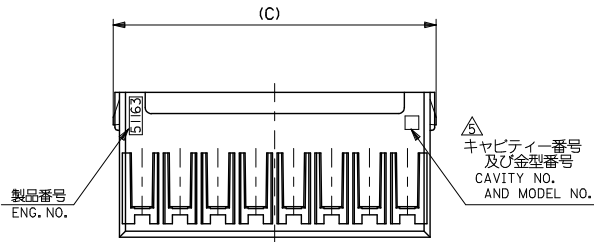

12.5	7.4	5	36.6	38.8	35	38	51163-158*	15
↑	↑	↑	34.1	36.3	32.5	35.5	↑ -148*	14
			31.6	33.8	30	33	↑ -138*	13
			29.1	31.3	27.5	30.5	↑ -128*	12
			26.6	28.8	25	28	↑ -118*	11
			24.1	26.3	22.5	25.5	↑ -108*	10
			21.6	23.8	20	23	↑ -098*	9
			19.1	21.3	17.5	20.5	↑ -088*	8
			16.6	18.8	15	18	↑ -078*	7
			14.1	16.3	12.5	15.5	↑ -068*	6
			11.6	13.8	10	13	↑ -058*	5
	7.4	5	9.1	11.3	7.5	10.5	↑ -048*	4
	5	3	6.6	8.8	5	8	51163-038*	3

REVISED EC NO. J2010-0288 DRAWN BY GOTO CHIKIDAKAKAWA APPROVED BY APPR. NIKITA	GENERAL TOLERANCES (UNLESS SPECIFIED)		DIMENSION STYLE MM ONLY		SCALE 4:1	DESIGN UNITS METRIC	THIRD ANGLE PROJECTION	
	10 UNDER	± 0.2	DRAWN BY K. HARADA		DATE 1997/10/2	TITLE 2.5 W/B CONN HSG (POSITIVE LOCK)		
	10 OVER 30 UNDER	± 0.25	CHECKED BY T. ITO		DATE 1997/11/12	MOLEX INCORPORATED		
	30 OVER	± 0.3	APPROVED BY M. FUKUSHIMA		DATE 1997/11/12	DOCUMENT NO. SD-51163-**-00		SHEET NO. 1 OF 2
ANGULAR ± 3 °		DRAFT WHERE APPLICABLE MUST REMAIN WITHIN DIMENSIONS		MATERIAL NO. ENTER PART		MOLEX INCORPORATED		
THIS DRAWING CONTAINS INFORMATION THAT IS PROPRIETARY TO MOLEX INCORPORATED AND SHOULD NOT BE USED WITHOUT WRITTEN PERMISSION								

10 9 8 7 6 5 4 3 2 1

注記 NOTES

- △ 適合ターミナル : 5035I-8*00
APPLICABLE TERMINAL : 5035I-8*00
- 2. 嵌合相手 : 53375,53426 シリーズ
MATE WITH : 53375,53426 SERIES
- △ 偶数極の製品に適用。
APPLY EVEN CIRCUIT PRODUCTS.
- △ トレードマーク : Mプラス 1 ~ 2 文字のアルファベットにて構成。(例 MX J)
但し * J* は JAPANを示す。
FORMED BY M AND 1 ~ 2 MORE LETTER OF ALPHABET (e.g. MXJ)
(TO TRADE MARK), BUT *J* SHOW JAPAN.
- △ キャビティー番号 : 1桁~2桁の数字
金型番号 : アルファベット1文字にて構成。(例. 1A, 10B)
FORMED BY 1 DIGIT TO 2 DIGIT NUMBERS (TO CAVITY NO.) AND BY 1 LETTER OF ALPHABET (TO MOLD NO.).
(e.g. 1A, 10B)

△ MATERIAL AND ORDER No.

51163-**00

極数
CIRCUIT SIZE

- 7. 材料 : PBT, UL 94V-0
- 8. 色 : 白 WHITE (NATURAL)

PRE-RELEASE
REFERENCE
USE ONLY

REVISED
EC NO. C
DRAWN BY GOTO
CHIKIDAKIKAWA
APPR.
2009/08/20

GENERAL TOLERANCES (UNLESS SPECIFIED)		DIMENSION STYLE MM ONLY		SCALE 4:1	DESIGN UNITS METRIC	THIRD ANGLE PROJECTION	
10 UNDER	± 0.2	DRAWN BY K. HARADA	DATE 1997/10/2	TITLE 2.5 W/B CONN HSG (POSITIVE LOCK)			
10 OVER 30 UNDER	± 0.25	CHECKED BY T. ITO	DATE 1997/11/12	APPROVED BY M. FUKUSHIMA			
30 OVER	± 0.3	DATE 1997/11/12		MOLEX INCORPORATED			
ANGULAR ± 3 °		MATERIAL NO.		ENTER PART		DOCUMENT NO.	SHEET NO.
DRAFT WHERE APPLICABLE MUST REMAIN WITHIN DIMENSIONS		SIZE A3		THIS DRAWING CONTAINS INFORMATION THAT IS PROPRIETARY TO MOLEX INCORPORATED AND SHOULD NOT BE USED WITHOUT WRITTEN PERMISSION		SD-51163-**00	2 OF 2

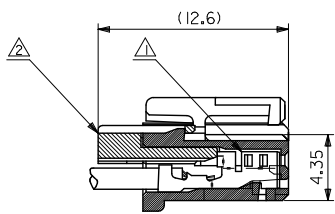
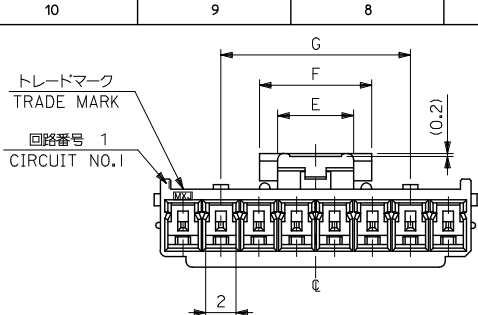

ターミナル及びリテーナー装着状態図
TERMINAL AND RETAINER ASSEMBLY DRAWING

注記 NOTES

- △ 適合ターミナル : 50752-8*00
APPLICABLE TERMINAL : 50752-8*00
- △ 適合リテーナー : 51164-***05
APPLICABLE RETAINER : 51164-***05
- 3. 嵌合相手 : 53375,53376,53388,53389,53426 シリーズ
MATE WITH : 53375,53376,53388,53389,53426 SERIES
- △ 偶数極の製品に適用。
APPLY EVEN CIRCUIT PRODUCTS.

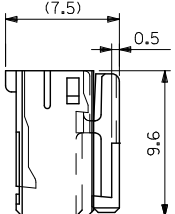
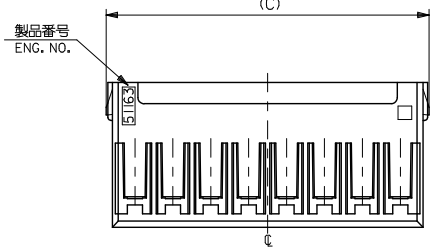

3-15 極に適用
FOR 3-15 CKTS.

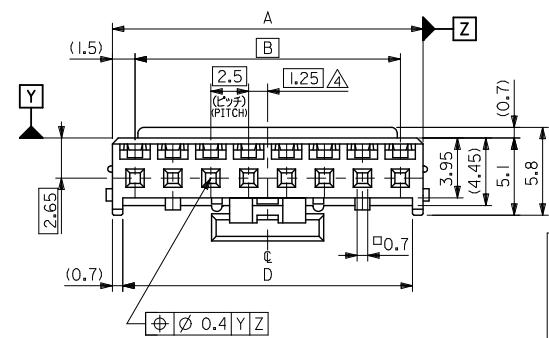

	青 BLUE	赤 RED	黒 BLACK	白 NATURAL	COLOR
12.5	51163-1504	51163-1502	51163-1501	51163-1500	15
12.5	-1404	-1402	-1401	-1400	14
12.5	-1304	-1302	-1301	-1300	13
12.5	-1204	-1202	-1201	-1200	12
12.5	-1104	-1102	-1101	-1100	11
12.5	-1004	-1002	-1001	-1000	10
12.5	-0904	-0902	-0901	-0900	9
12.5	-0804	-0802	-0801	-0800	8
12.5	-0704	-0702	-0701	-0700	7
12.5	-0604	-0602	-0601	-0600	6
12.5	-0504	-0502	-0501	-0500	5
12.5	-0404	-0402	-0401	-0400	4
7.4	51163-0304	51163-0302	51163-0301	51163-0300	3
5					

REVISED IEC NO. J2005-1394 2004/11/09 DRAWN: ISASAMOR 2004/11/10 CHIKOKI TOJO 2004/11/18 APPROX: NUKITA	GENERAL TOLERANCES (UNLESS SPECIFIED)	DIMENSION STYLE MM ONLY	SCALE 4:1	DESIGN UNITS METRIC	THIRD ANGLE PROJECTION
	10 UNDER ±0.2	DRAWN BY J. SASAMO	DATE 2004/8/31	TITLE 2.5 WIRE TO BORAD CONN. HOUSING (POSITIVE LOCK) WITH RETAINER	
	10 OVER 30 UNDER ±0.25	CHECKED BY K. TOJO	DATE 2004/8/31	MOLEX INCORPORATED	
	30 OVER ±0.3	APPROVED BY N. UKITA	DATE 2004/8/31	MATERIAL NO. 51163-***0*	DOCUMENT NO. SD-51163-001
ANGULAR ±3°	DRAFT WHERE APPLICABLE MUST REMAIN WITHIN DIMENSIONS		THIS DRAWING CONTAINS INFORMATION THAT IS PROPRIETARY TO MOLEX INCORPORATED AND SHOULD NOT BE USED WITHOUT WRITTEN PERMISSION		

MATERIAL
PBTP, UL94V-0
SEE CHART

10 9 8 7 6 5 4 3 2 1

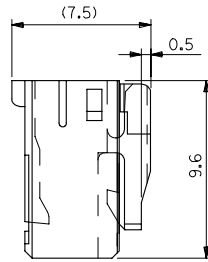
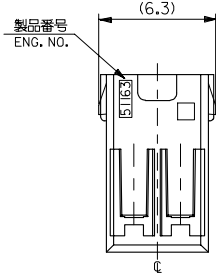
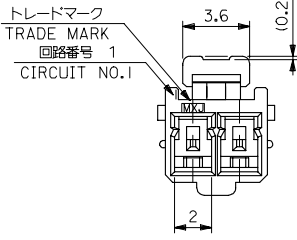

注記 NOTES

- △ 適合ターミナル : 50752-8*00
APPLICABLE TERMINAL : 50752-8*00
- △ 適合リテーナー : 51164-***05
APPLICABLE RETAINER : 51164-***05
- 3. 嵌合相手 : 53375,53426 シリーズ
MATE WITH : 53375,53426 SERIES

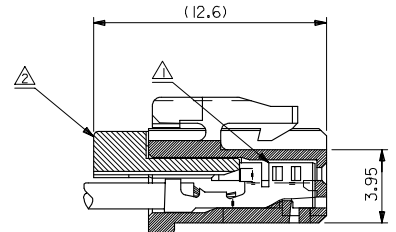

ターミナル及びリテーナー装着状態図
TERMINAL AND RETAINER ASSEMBLY DRAWING

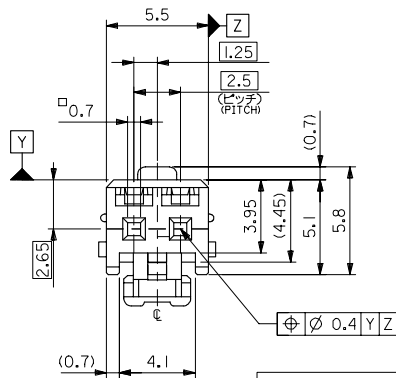

2極に適用
FOR 2 CKTS.

MATERIAL
PBTP, UL94V-0
SEE CHART

青 BLUE	51163-0204	2
赤 RED	51163-0202	
黒 BLACK	51163-0201	
白 NATURAL	51163-0200	
COLOR MATERIAL NO.	MATERIAL NO.	NO. OF CKT.

REVISED EC NO: J2005-1394 DRAWN: SASAMOR 2004/11/09 CHKD: TOJO 2004/11/10 APPR: NUKITA 2004/11/18 REV: A	GENERAL TOLERANCES (UNLESS SPECIFIED)		DIMENSION STYLE MM ONLY		SCALE 5:1	DESIGN UNITS METRIC	THIRD ANGLE PROJECTION
	10 UNDER	± 0.2	DRAWN BY J. SASAMO	DATE 2004/8/31	TITLE 2.5 WIRE TO BORAD CONN. HOUSING (POSITIVE LOCK) WITH RETAINER Molex MOLEX INCORPORATED		
	10 OVER 30 UNDER	± 0.25	CHECKED BY K. TOJO	DATE 2004/8/31			
	30 OVER	± 0.3	APPROVED BY N. UKITA	DATE 2004/8/31	MATERIAL NO. 51163-***0*	DOCUMENT NO. SD-51163-001	SHEET NO. 2 OF 2
ANGULAR ± 3 °		DRAFT WHERE APPLICABLE MUST REMAIN WITHIN DIMENSIONS		SIZE THIS DRAWING CONTAINS INFORMATION THAT IS PROPRIETARY TO MOLEX INCORPORATED AND SHOULD NOT BE USED WITHOUT WRITTEN PERMISSION			