

Excellent Integrated System Limited

Stocking Distributor

Click to view price, real time Inventory, Delivery & Lifecycle Information:

[Molex Connector Corporation](#)
[0532591329](#)

For any questions, you can email us directly:

sales@integrated-circuit.com

10 9 8 7 6 5 4 3 2 1

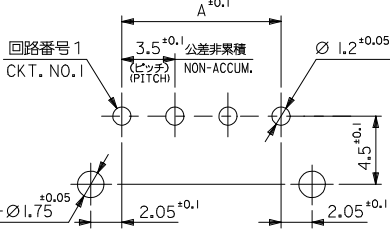
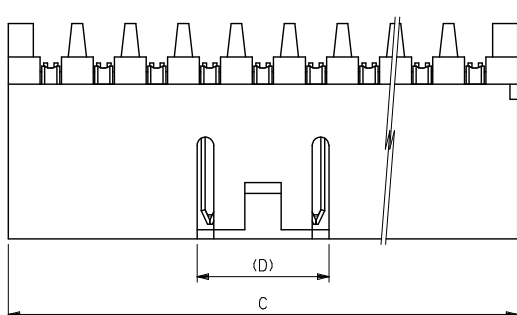

基板取付穴推奨寸法 (参考) (t=1.6)
RECOMMENDED P.C. BOARD HOLE DIM. (REF.)

注記 NOTES

- 嵌合相手: 51067 シリーズ
MATE WITH : 51067 SERIES
- 材質 MATERIAL
ワイヤー: PBTP (ガラス15%入り), UL94V-0
WAFER: PBTP (G.F 15%), UL94V-0
ピン: 黄銅, ニッケル下地 鍍メッキ (t=0.254)
PIN: BRASS
TIN OVER NICKEL PLATING (t=0.254)
- 本製品は 53259-***20 の鉛フリー品である。
THIS PRODUCT IS LEAD FREE OF 53259-***20.
- メッキ仕様
TERMINAL PLATING
表面メッキ: スズメッキ 14μm MIN.
SURFACE PLATE: TIN 14μm MIN.
下地メッキ: ニッケルメッキ 14μm MIN.
UNDER PLATE: NICKEL 14μm MIN.

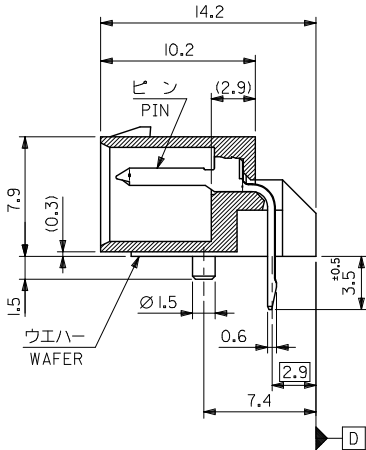
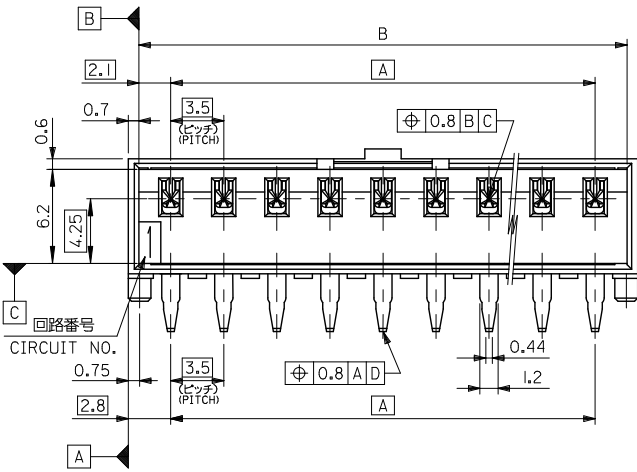

8.7	54.6	53.2	49.0	53259-1529	15
	51.1	49.7	45.5	-1429	14
	47.6	46.2	42.0	-1329	13
	44.1	42.7	38.5	-1229	12
	40.6	39.2	35.0	-1129	11
	37.1	35.7	31.5	-1029	10
	33.6	32.2	28.0	-0929	9
	30.1	28.7	24.5	-0829	8
	26.6	25.2	21.0	-0729	7
	23.1	21.7	17.5	-0629	6
	19.6	18.2	14.0	-0529	5
8.7	16.1	14.7	10.5	-0429	4
6.1	12.6	11.2	7.0	-0329	3
6.1	9.1	7.7	3.5	53259-0229	2
(D)	C	B	A	TRAY PACKAGE	CKT. 極数

REVISED IEC NO. J2010-0817 DRAWN: SKUROSE CHIKUDASAKAWA APPROX: NIKITA 2009/10/22 2009/10/22 2009/10/22	GENERAL TOLERANCES (UNLESS SPECIFIED)		DIMENSION STYLE	SCALE	DESIGN UNITS	MODEL NO. 53259-***29 THIRD ANGLE PROJECTION
	10 UNDER ±0.2		MM ONLY	4:1	METRIC	
	10 OVER 30 UNDER ±0.25		DRAWN BY	DATE	TITLE	
	30 OVER ±0.3		T. UENO	2004/04/22	3.5 W/B CONN W.A. R/A -LEAD FREE-	
ANGULAR ±3°		CHECKED BY	DATE	MOLEX INCORPORATED		
DRAFT WHERE APPLICABLE MUST REMAIN WITHIN DIMENSIONS		M. SASAO	2004/04/22	SD-53259-003		
		APPROVED BY	DATE	SHEET NO. 1 OF 1		
		M. SASAO	2004/04/22			
		SEE TABLE		THIS DRAWING CONTAINS INFORMATION THAT IS PROPRIETARY TO MOLEX INCORPORATED AND SHOULD NOT BE USED WITHOUT WRITTEN PERMISSION		

MATERIAL 材料
注記参照
SEE NOTES