

Excellent Integrated System Limited

Stocking Distributor

Click to view price, real time Inventory, Delivery & Lifecycle Information:

[Molex Connector Corporation](#)
[0874272443](#)

For any questions, you can email us directly:

sales@integrated-circuit.com

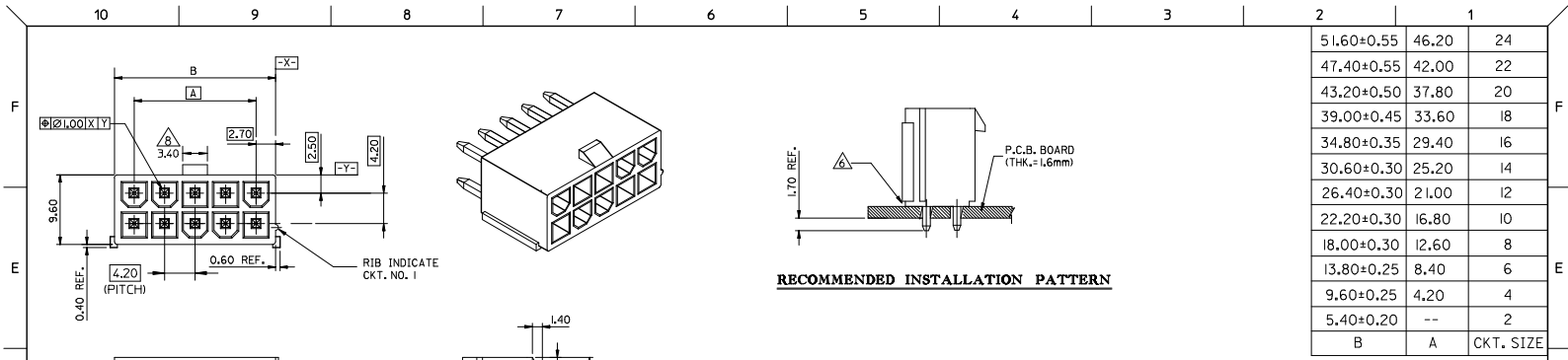

RECOMMENDED INSTALLATION PATTERN

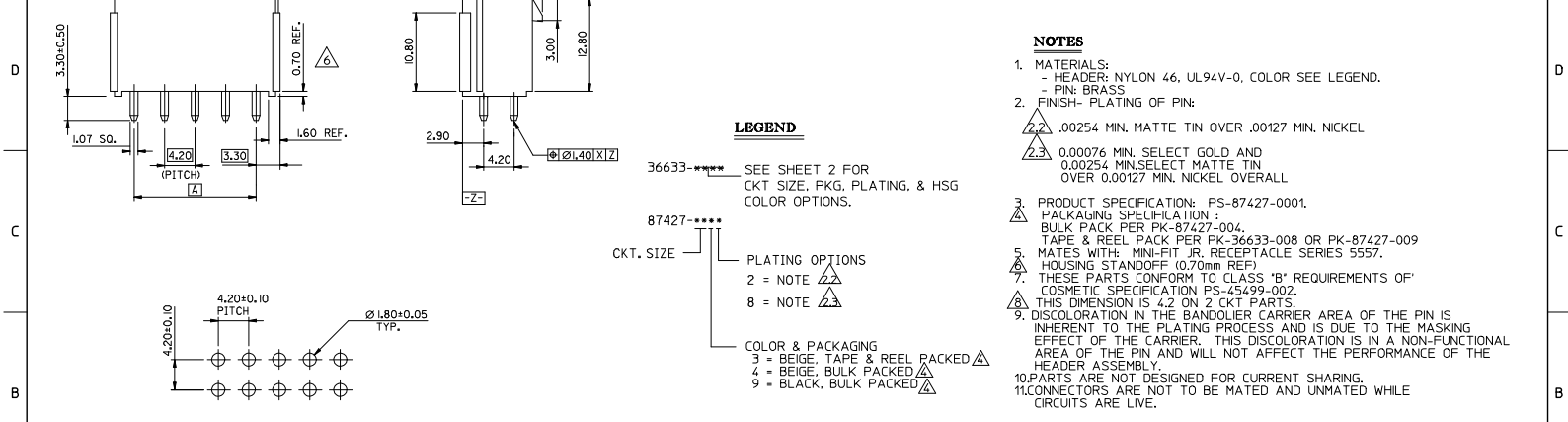

NOTES

- MATERIALS:
 - HEADER: NYLON 46, UL94V-0, COLOR SEE LEGEND.
 - PIN: BRASS
- FINISH- PLATING OF PIN:
 .00254 MIN. MATTE TIN OVER .00127 MIN. NICKEL
 0.00076 MIN. SELECT GOLD AND 0.00254 MIN. SELECT MATTE TIN OVER 0.00127 MIN. NICKEL OVERALL
- PRODUCT SPECIFICATION: PS-87427-0001.
 PACKAGING SPECIFICATION:
 BULK PACK PER PK-87427-004.
 TAPE & REEL PACK PER PK-36633-008 OR PK-87427-009
- MATES WITH: MINI-FIT JR. RECEPTACLE SERIES 5557.
- HOUSING STANDOFF (0.70mm REF)
- THESE PARTS CONFORM TO CLASS 'B' REQUIREMENTS OF COSMETIC SPECIFICATION PS-45499-002.
- THIS DIMENSION IS 4.2 ON 2 CKT PARTS.
- DISCOLORATION IN THE BANDOLIER CARRIER AREA OF THE PIN IS INHERENT TO THE PLATING PROCESS AND IS DUE TO THE MASKING EFFECT OF THE CARRIER. THIS DISCOLORATION IS IN A NON-FUNCTIONAL AREA OF THE PIN AND WILL NOT AFFECT THE PERFORMANCE OF THE HEADER ASSEMBLY.
- PARTS ARE NOT DESIGNED FOR CURRENT SHARING.
- CONNECTORS ARE NOT TO BE MATED AND UNMATED WHILE CIRCUITS ARE LIVE.

RECOMMENDED P.C.B. LAYOUT

OBS P/N 'S EC. NO.: LCP2013-1112 DRAWN BY: DRWINBREE CHKD: BELL APPR: SMITH	QUALITY SYMBOLS ▽=0 ▽=0 ▽=0	GENERAL TOLERANCES (UNLESS SPECIFIED)		DIMENSION STYLE MM ONLY		SCALE 4:1	DESIGN UNITS METRIC	THIRD ANGLE PROJECTION	
		mm	INCH	DRAWN BY SAM.C	DATE 960401	TITLE 4.2MM W-T-B VERT. HEADER W/O FLANGES MINI-FIT JR			
REV	DESCRIPTION	4 PLACES	± ---	± ---	CHECKED BY	DATE	 DOCUMENT NO. SD-87427-***4* SHEET NO. 1 OF 2		
		3 PLACES	± ---	± ---	APPROVED BY	DATE			
		2 PLACES	± 0.20	± ---	FSMITH	2010/10/04			
		1 PLACE	± ---	± ---	MATERIAL NO. SEE CHART				
		0 PLACE	± ---	± ---	SIZE B THIS DRAWING CONTAINS INFORMATION THAT IS PROPRIETARY TO MOLEX INCORPORATED AND SHOULD NOT BE USED WITHOUT WRITTEN PERMISSION				

	10	9	8	7	6	5	4	3	2	1	
F											
E											
D											
C											
B											
A											

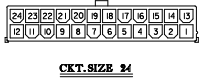
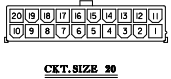
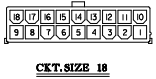
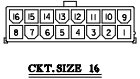
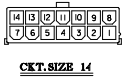

CONSULT FACTORY FOR AVAILABILITY

BULK PACKED PLATING=TIN Δ Δ COLOR=BLACK		BULK PACKED PLATING=GOLD Δ Δ COLOR=BEIGE		TAPE & REEL PACKED PLATING=TIN Δ Δ COLOR=BEIGE		BULK PACKED PLATING=TIN Δ Δ COLOR=BEIGE	
ENG. NO.	CKT. SIZE	ENG. NO.	CKT. SIZE	ENG. NO.	CKT. SIZE	ENG. NO.	CKT. SIZE
# 87427-2492	24	87427-2448	24	# 87427-2432	24	87427-2442	24
# 87427-2292	22	87427-2248	22	# 87427-2232	22	87427-2242	22
# 87427-2092	20	87427-2048	20	# 87427-2032	20	87427-2042	20
# 87427-1892	18	87427-1848	18	# 87427-1832	18	87427-1842	18
# 87427-1692	16	87427-1648	16	# 87427-1632	16	87427-1642	16
# 87427-1492	14	87427-1448	14	# 87427-1432	14	87427-1442	14
# 87427-1292	12	87427-1248	12	# 87427-1232	12	87427-1242	12
# 87427-1092	10	87427-1048	10	# 87427-1032	10	87427-1042	10
# 87427-0892	8	87427-0848	8	# 87427-0832	8	87427-0842	8
# 87427-0692	6	87427-0648	6	36633-0010	6	87427-0642	6
# 87427-0492	4	87427-0448	4	36633-0009	4	87427-0442	4
# 87427-0292	2	87427-0248	2	36633-0008	2	87427-0242	2

SEE SHEET 1 EC NO: UCP2013-112 DRW:BBE CHKD:JBL APPR:FSMITH 2012/09/18 2012/09/20 2012/09/25	QUALITY SYMBOLS $\nabla=0$ $\nabla=0$ $\nabla=0$	GENERAL TOLERANCES (UNLESS SPECIFIED)		DIMENSION STYLE MM ONLY		SCALE 2:1	DESIGN UNITS METRIC	THIRD ANGLE PROJECTION 4.2MM W-T-B VERT. HEADER W/O FLANGES MINI-FIT JR molex SD-87427-*** SHEET NO. 2 OF 2
		4 PLACES \pm --- \pm --- 3 PLACES \pm --- \pm --- 2 PLACES \pm 0.20 \pm --- 1 PLACE \pm --- \pm --- 0 PLACE \pm --- \pm ---		DRAWN BY DATE SAM.C 960401 CHECKED BY DATE		TITLE		
		ANGULAR \pm --- DRAFT WHERE APPLICABLE MUST REMAIN WITHIN DIMENSIONS		APPROVED BY DATE FSMITH 2010/10/04		MATERIAL NO. SEE CHART		
				DOCUMENT NO. SD-87427-***				