

Excellent Integrated System Limited

Stocking Distributor

Click to view price, real time Inventory, Delivery & Lifecycle Information:

[Molex Connector Corporation](#)
[0877030068](#)

For any questions, you can email us directly:
sales@integrated-circuit.com

10	9	8	7	6	5	4	3	2	1
----	---	---	---	---	---	---	---	---	---

PART NUMBER	PACKAGING
87703-0001	TRAY
87703-0068	TAPE & REEL

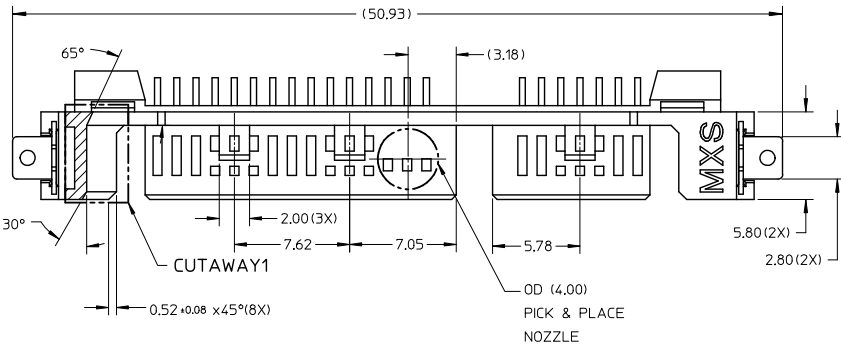

NOTES:

- MATERIAL:
HOUSING: LIQUID CRYSTALLINE POLYMER (LCP), GLASS FILLED UL 94V-0, COLOR: BLACK
CONTACTS & SMT NAILS: COPPER ALLOY
- PLATING FINISH ON CONTACTS AND SOLDER TAILS:
0.127µm MIN. GOLD FLASH OVER 1.27µm MIN. NICKEL UNDERPLATE
- PLATING FINISH ON SMT NAILS:
3.18µm MIN. TIN OVER 1.27µm MIN. NICKEL UNDERPLATE
- PRODUCT SPECIFICATION: PS-87703-017 APPLIES
- PRODUCT CONFORMS TO SERIAL ATA SPECIFICATION.
- PACKAGING: SEE TABLE
- PRODUCT IS COMPLIANT TO RoHS DIRECTIVE WITH THE FOLLOWING BANNED SUBSTANCES - LEAD, MERCURY, CADMIUM, HEXAVALENT CHROMIUM, POLYBROMINATED BIPHENYLS AND POLYBROMINATED DIPHENYL ETHERS.
- MATES WITH: SATA RECEPTACLE SERIES: 87678, 87701, 87713, 87779, 87780, 87781
SFF-8482 RECEPTACLE SERIES: 87824, 87839, 87863, 87970

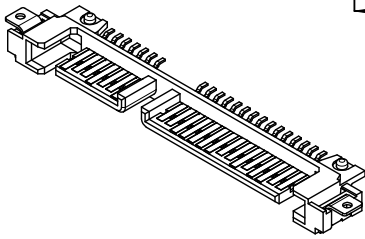
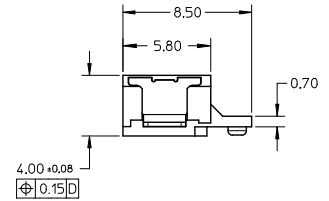
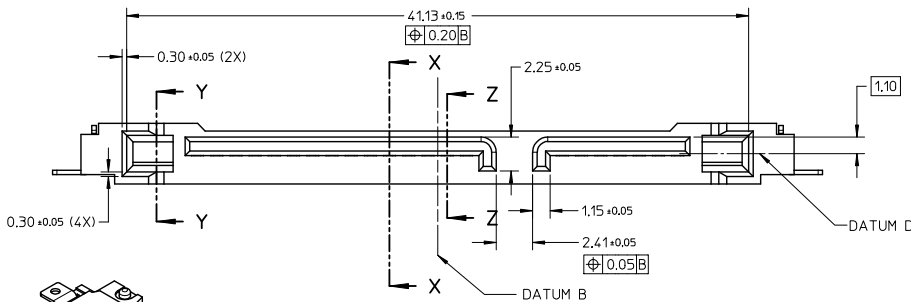

OBS P/N: 87703-0067 IEC No: S2014-0743 DRAWNSKANG 2014/02/07 CHYKHLONG 2014/03/31 APPR: JILONG 2014/03/31	QUALITY SYMBOLS	GENERAL TOLERANCES (UNLESS SPECIFIED)		DIMENSION STYLE		SCALE	DESIGN UNITS	THIRD ANGLE PROJECTION		
	$\nabla=0$ $\nabla=0$ $\nabla=0$	4 PLACES	mm	INCH	MM ONLY		NTS	METRIC	SERIAL ATA PLUG 2.5 INCH HDD	
		3 PLACES	±---	±---	DRAWN BY	DATE	TITLE	MOLEX INCORPORATED DOCUMENT NO. SD-87703-002 SHEET NO. 1 OF 5		
		2 PLACES	±0.20	±---	CHECKED BY	DATE				
	1 PLACE	±---	±---	APPROVED BY	DATE	THIS DRAWING CONTAINS INFORMATION THAT IS PROPRIETARY TO MOLEX INCORPORATED AND SHOULD NOT BE USED WITHOUT WRITTEN PERMISSION				
	ANGULAR ± 3°		DRAFT WHERE APPLICABLE MUST REMAIN WITHIN DIMENSIONS		SEE TABLE					

9	8	7	6	5	4	3	2	1
---	---	---	---	---	---	---	---	---

10 9 8 7 6 5 4 3 2 1

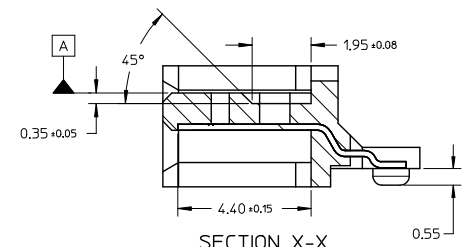
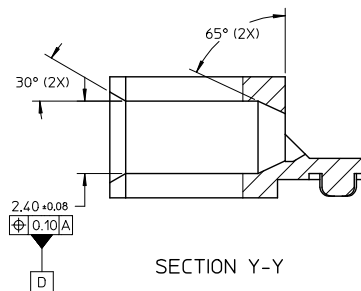
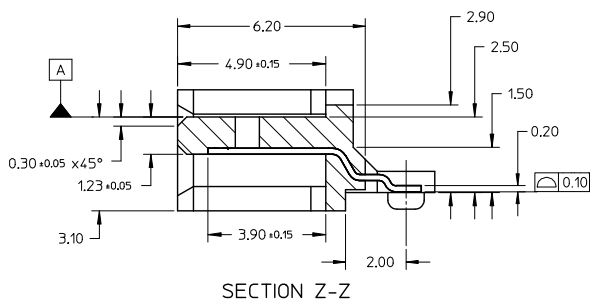
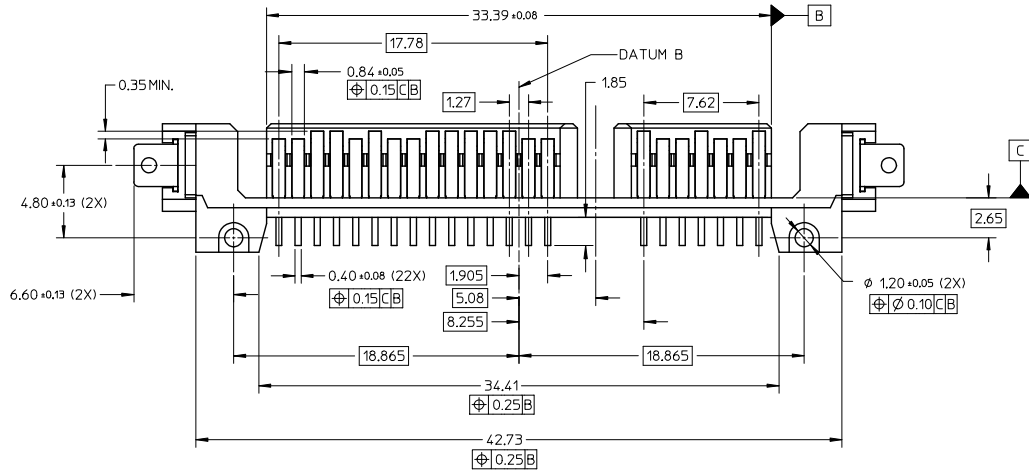

OBS P/N: 87703-0067 EC No: S2014-0743 DRAWNSKANG 2014/02/07 CHKD:LONG 2014/03/31 APPR:LONG 2014/03/31	QUALITY SYMBOLS	GENERAL TOLERANCES (UNLESS SPECIFIED)		DIMENSION STYLE MM ONLY		SCALE NTS	DESIGN UNITS METRIC	THIRD ANGLE PROJECTION	
	$\nabla=0$ $\nabla=0$ $\nabla=0$	4 PLACES ± --- ± ---	3 PLACES ± --- ± ---	2 PLACES ± 0.20 ± ---	1 PLACE ± --- ± ---	ANGULAR ± 3°	DRAWN BY RSHAN	DATE 2002/11/18	TITLE SERIAL ATA PLUG 2.5 INCH HDD
	DRAFT WHERE APPLICABLE MUST REMAIN WITHIN DIMENSIONS		SEE TABLE		APPROVED BY SKTOH		DATE 2002/12/18	MATERIAL NO. DOCUMENT NO. SD-87703-002	
	SIZE A3		THIS DRAWING CONTAINS INFORMATION THAT IS PROPRIETARY TO MOLEX INCORPORATED AND SHOULD NOT BE USED WITHOUT WRITTEN PERMISSION						

9 8 7 6 5 4 3 2 1

10 9 8 7 6 5 4 3 2 1

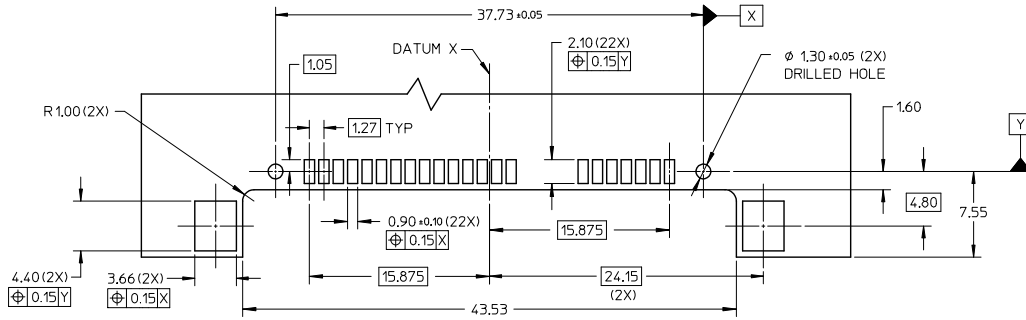

RECOMMENDED PCB LAYOUT
PCB THICKNESS : 0.50±0.08

OBS P/N: 87703-0067 EC NO: S2014-0743 DRAWNSKANG 2014/02/07 CHKCHILONG 2014/03/31 APPR:AILONG 2014/03/31	QUALITY SYMBOLS	GENERAL TOLERANCES (UNLESS SPECIFIED)		DIMENSION STYLE MM ONLY		SCALE NTS	DESIGN UNITS METRIC	THIRD ANGLE PROJECTION	
	$\nabla=0$ $\nabla=0$ $\nabla=0$	4 PLACES	±---	±---	DRAWN BY RSHAN	DATE 2002/11/18	TITLE SERIAL ATA PLUG 2.5 INCH HDD		
		3 PLACES	±---	±---	CHECKED BY KCLING	DATE 2002/12/18	MOLEX INCORPORATED		
		2 PLACES	±0.20	±---	APPROVED BY SKTOH	DATE 2002/12/18	DOCUMENT NO. SD-87703-002	SHEET NO. 3 OF 5	
	1 PLACE	±---	±---	MATERIAL NO. SEE TABLE		THIS DRAWING CONTAINS INFORMATION THAT IS PROPRIETARY TO MOLEX INCORPORATED AND SHOULD NOT BE USED WITHOUT WRITTEN PERMISSION			
		ANGULAR ± 3°		DRAFT WHERE APPLICABLE MUST REMAIN WITHIN DIMENSIONS					

9 8 7 6 5 4 3 2 1

10 9 8 7 6 5 4 3 2 1

TRAY PACKAGING

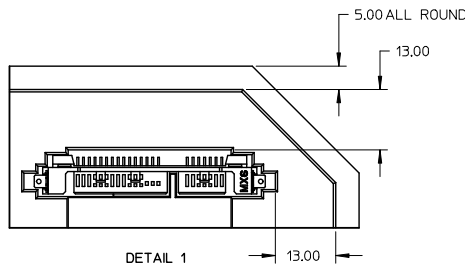
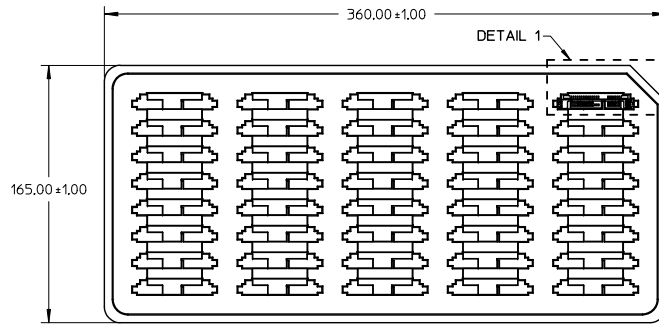

OBS P/N: 87703-0067 EC NO: S2014-0743 DRAWN: SKANG 2014/02/07 CHK: CHILONG 2014/03/31 APPR: HILONG 2014/03/31	QUALITY SYMBOLS ▽=0 ▽=0 ▽=0	GENERAL TOLERANCES (UNLESS SPECIFIED)		DIMENSION STYLE MM ONLY		SCALE NTS	DESIGN UNITS METRIC	THIRD ANGLE PROJECTION		
		4 PLACES ± --- ± ---	3 PLACES ± --- ± ---	2 PLACES ± 0.20 ± ---	1 PLACE ± --- ± ---	ANGULAR ± 3 °	DRAWN BY RSHAN	DATE 2002/11/18	TITLE SERIAL ATA PLUG 2.5 INCH HDD	
		DRAFT WHERE APPLICABLE MUST REMAIN WITHIN DIMENSIONS		MATERIAL NO. SEE TABLE		APPROVED BY SKTOH		DATE 2002/12/18	MOLEX INCORPORATED	
		SIZE A 3		THIS DRAWING CONTAINS INFORMATION THAT IS PROPRIETARY TO MOLEX INCORPORATED AND SHOULD NOT BE USED WITHOUT WRITTEN PERMISSION		DOCUMENT NO. SD-87703-002		SHEET NO. 4 OF 5		

9 8 7 6 5 4 3 2 1

10 9 8 7 6 5 4 3 2 1

TAPE & REEL PACKAGING

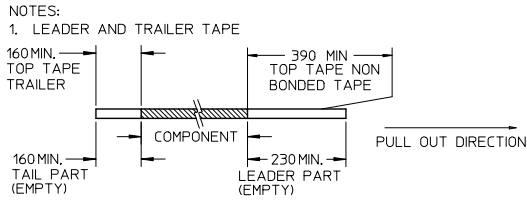
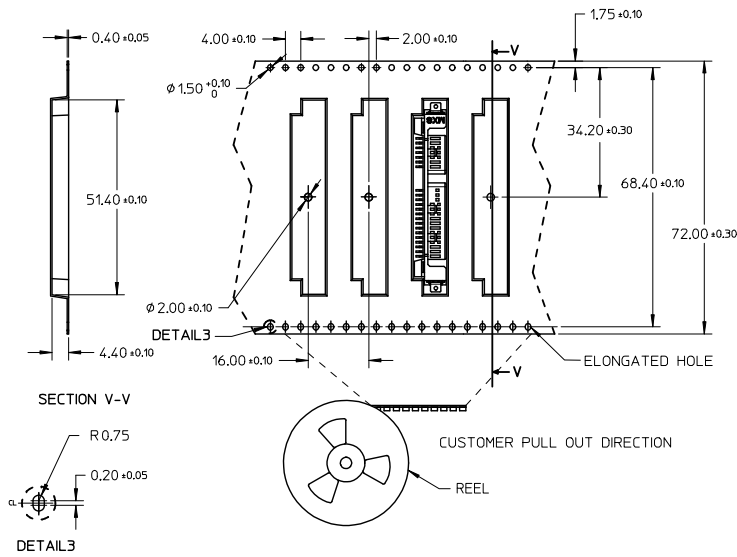

- PEELING OFF FORCE OF THE TOP TAPE: 20 - 60gf. (PEELING DIRECTION AS SHOWN IN FOLLOWING FIGURE)
- TAPE AND REEL SPECIFICATION IS AS PER EIA-481.
- TAPE AND REEL QUANTITY : 850 PCS/ REEL.
- THE TAPE IS TREATED FOR ANTI-STATIC.

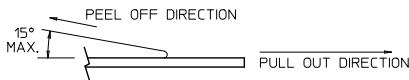

OBS P/N: 87703-0067 EC NO: S2014-0743 DRAWN BY: CHYKSHANG CHKD BY: CHYKSHANG APPR: HLONG	QUALITY SYMBOLS √=0 √=0 √=0	GENERAL TOLERANCES (UNLESS SPECIFIED)		DIMENSION STYLE MM ONLY		SCALE NTS	DESIGN UNITS METRIC	THIRD ANGLE PROJECTION	
		4 PLACES ± --- ± ---	3 PLACES ± --- ± ---	2 PLACES ± 0.20 ± ---	1 PLACE ± --- ± ---	ANGULAR ± 3 °	DRAWN BY: RSHAN DATE: 2002/11/18	CHECKED BY: KCLING DATE: 2002/12/18	APPROVED BY: SKTOH DATE: 2002/12/18
DRAFT WHERE APPLICABLE MUST REMAIN WITHIN DIMENSIONS		MATERIAL NO. SEE TABLE		DOCUMENT NO. SD-87703-002		MOLEX INCORPORATED		SHEET NO. 5 OF 5	
THIS DRAWING CONTAINS INFORMATION THAT IS PROPRIETARY TO MOLEX INCORPORATED AND SHOULD NOT BE USED WITHOUT WRITTEN PERMISSION									

9 8 7 6 5 4 3 2 1