

## Excellent Integrated System Limited

Stocking Distributor

Click to view price, real time Inventory, Delivery & Lifecycle Information:

[Comchip Technology](#)  
[1SS400-G](#)

For any questions, you can email us directly:

[sales@integrated-circuit.com](mailto:sales@integrated-circuit.com)

## SMD Switching Diodes



# 1SS400-G

**Reverse Voltage: 90 Volts**  
**Rectifying Current: 100 mA**  
**RoHS Device**

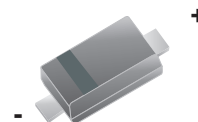

### Features

- High speed switching.
- Small surface mounting type.
- High reliability with high surge current handling capability.

### Mechanical data

- Case: SOD-523 standard package, Molded Plastic
- Terminals: Solderable per MIL-STD-750, method 2026
- Marking code: cathode band & A
- Mounting position: Any
- Weight: 0.012 gram(approx.)

### Circuit Diagram

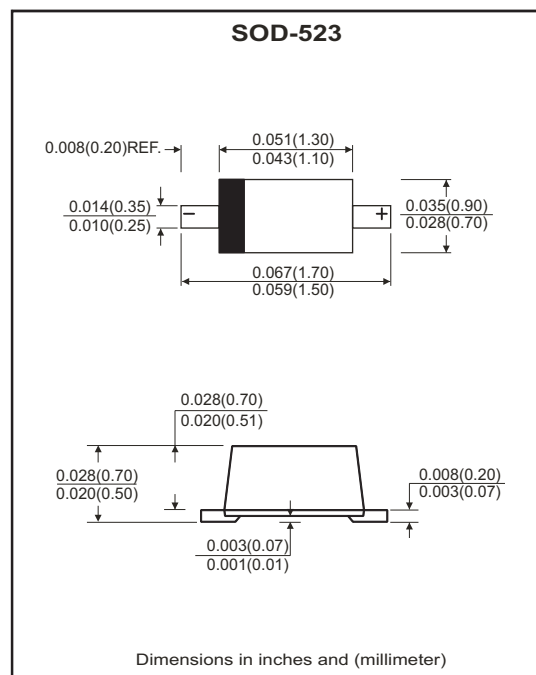

### Maximum Ratings (at $T_A=25^{\circ}\text{C}$ unless otherwise noted)

Parameter	Symbol	1SS400-G	Unit
Peak reverse voltage	$V_{RM}$	90	V
DC reverse voltage	$V_{DC}$	80	V
Peak forward current	$I_{FM}$	225	mA
Mean rectified current	$I_o$	100	mA
Surge current	$I_{FSM}$	500	mA
Power dissipation	$P_D$	150	mW
Junction temperature	$T_J$	150	$^{\circ}\text{C}$
Storage temperature range	$T_{STG}$	-55 ~ +150	$^{\circ}\text{C}$

### Electrical Characteristics (at $T_A=25^{\circ}\text{C}$ unless otherwise noted)

Parameter	Symbol	Conditions	Min.	Typ.	Max.	Unit
Forward voltage	$V_F$	$I_F=100\text{mA}$	-----	-----	1.2	V
Reverse current	$I_R$	$V_R=80\text{V}$	-----	-----	0.1	$\mu\text{A}$
Capacitance between terminals	$C_T$	$V_R=0.5\text{V}$ , $f=1.0\text{MHz}$	-----	0.72	3.0	pF
Reverse recovery time	$t_{rr}$	$V_R=6\text{V}$ , $I_F=10\text{mA}$ , $R_L=100\Omega$	-----	-----	4.0	nS

# SMD Switching Diodes



## RATING AND CHARACTERISTIC CURVES (1SS400-G)

Fig.1 - Power Derating Curve

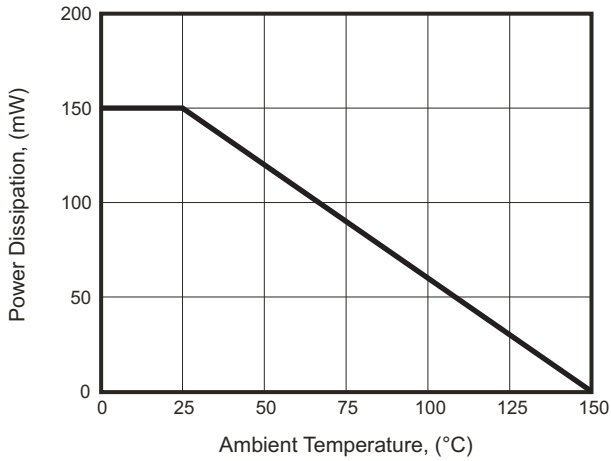

Fig.2 - Forward Characteristics

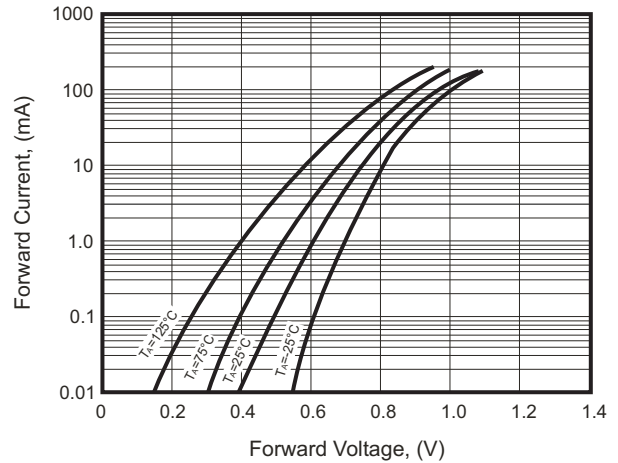

Fig.3 - Reverse Characteristics

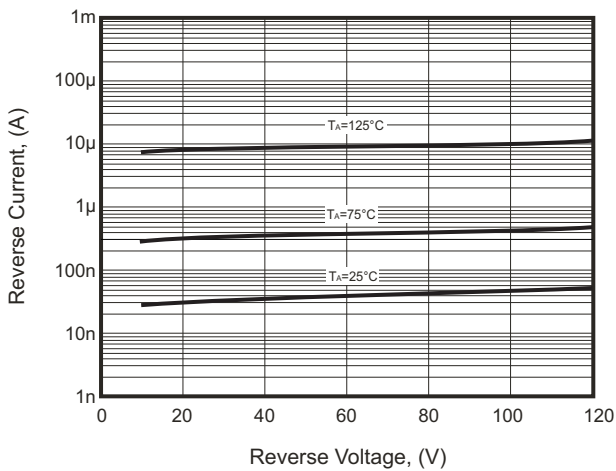

Fig.4 - Capacitance between terminals

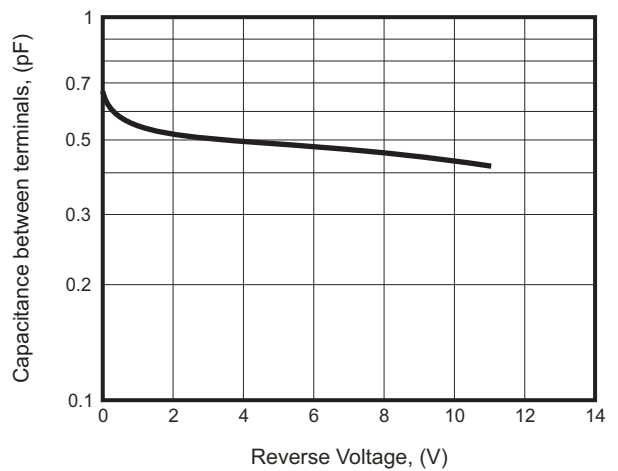

Fig.5 - Reverse Recovery Time Characteristics

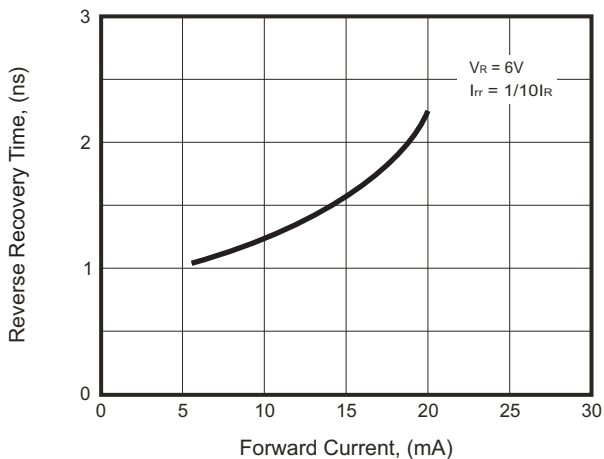
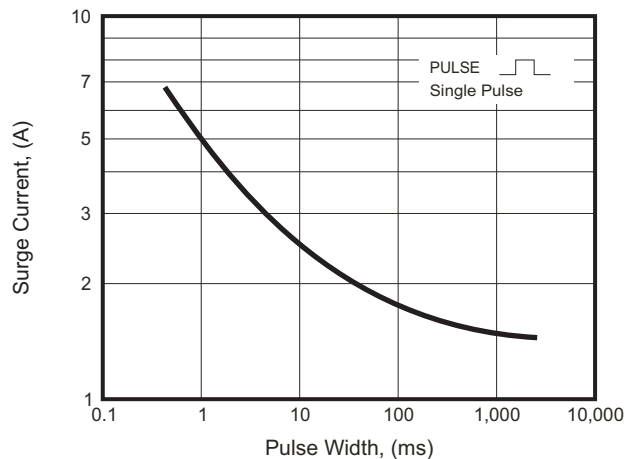

Fig.6 - Surge Current Characteristics



# SMD Switching Diodes



## Reel Taping Specification

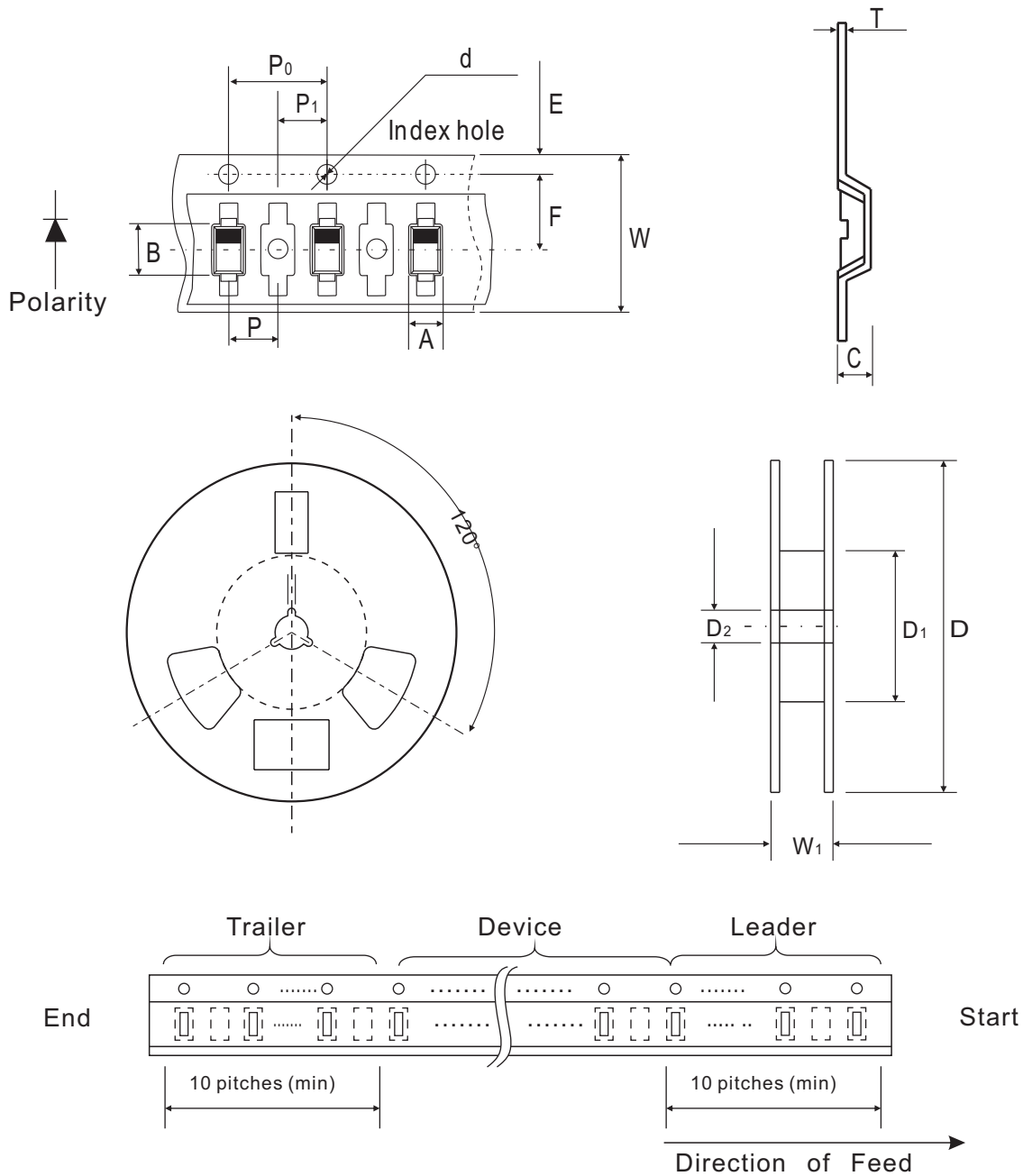

SOD-523	SYMBOL	A	B	C	d	D	D <sub>1</sub>	D <sub>2</sub>
	(mm)	0.90 ± 0.10	1.94 ± 0.10	0.73 ± 0.10	1.50 ± 0.10	178 ± 1.00	54.40 ± 0.40	13.00 ± 0.20
	(inch)	0.035 ± 0.004	0.076 ± 0.004	0.029 ± 0.004	0.059 ± 0.004	7.008 ± 0.039	2.142 ± 0.016	0.512 ± 0.008

SOD-523	SYMBOL	E	F	P	P <sub>0</sub>	P <sub>1</sub>	W	W <sub>1</sub>
	(mm)	1.75 ± 0.10	3.50 ± 0.05	2.00 ± 0.10	4.00 ± 0.10	2.00 ± 0.10	8.00 ± 0.30 / - 0.10	9.50 ± 1.00
	(inch)	0.069 ± 0.004	0.138 ± 0.002	0.079 ± 0.004	0.158 ± 0.004	0.079 ± 0.004	0.315 ± 0.012 / - 0.004	0.374 ± 0.039

## SMD Switching Diodes

### Marking Code

Part Number	Marking Code	
1SS400-G	A	A Σ

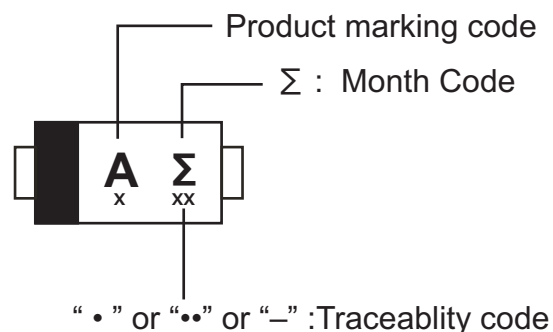

### Month Code:

Month	Odd Year (per A.D.)	Even Year (per A.D.)
Jan	1	E
Feb	2	F
Wer	3	H
Apr	4	J
May	5	K
Jun	6	L

Month	Odd Year (per A.D.)	Even Year (per A.D.)
Jul	7	N
Aug	8	P
Sep	9	U
Oct	T	X
Nov	V	Y
Dec	C	Z

### Suggested PAD Layout

SIZE	SOD-523	
	(mm)	(inch)
A	1.32	0.052
B	0.48	0.019
C	0.40	0.016
D	1.80	0.071
E	0.84	0.033

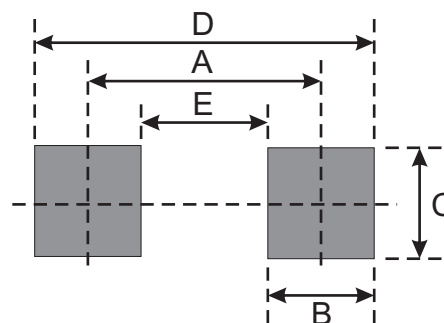

### Standard Packaging

Case Type	REEL PACK	
	REEL ( pcs )	Reel Size (inch)
SOD-523	3,000	7
	8,000	7