

## Excellent Integrated System Limited

Stocking Distributor

Click to view price, real time Inventory, Delivery & Lifecycle Information:

[Comchip Technology](#)  
[CDBF43-HF](#)

For any questions, you can email us directly:

[sales@integrated-circuit.com](mailto:sales@integrated-circuit.com)

# SMD Schottky Barrier Diode



## CDBF42/43-HF

$I_o = 200 \text{ mA}$   
 $V_R = 30 \text{ Volts}$   
 RoHS Device  
 Halogen Free

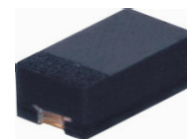

### Features

- Low forward voltage.
- Designed for mounting on small surface.
- Extremely thin / leadless package.
- Majority carrier conduction.

### Mechanical data

- Case: 1005/SOD-323F standard package, molded plastic.
- Terminals: Gold plated, solderable per MIL-STD-750, method 2026.
- Marking code:  
     CDBF42-HF : BD  
     CDBF43-HF : BE
- Mounting position: Any
- Weight: 0.006 gram(approx.).

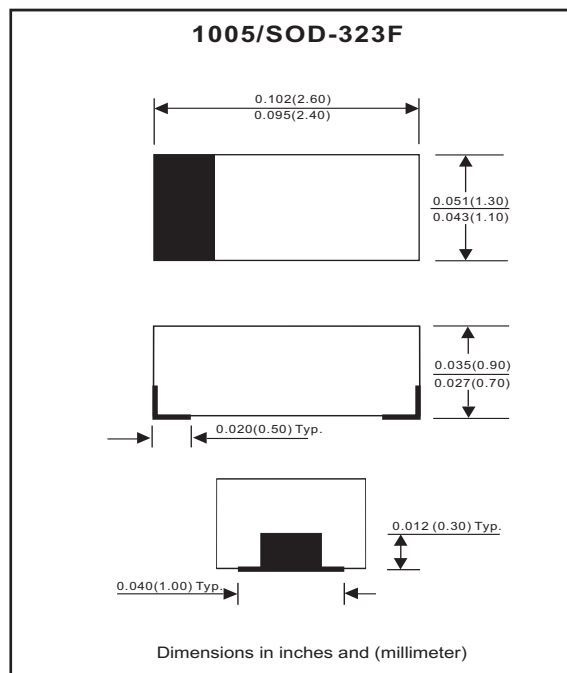

### Maximum Rating (at TA=25°C unless otherwise noted)

Parameter	Conditions	Symbol	Min	Typ	Max	Unit
Peak reverse voltage		$V_{RM}$			30	V
Reverse voltage		$V_R$			30	V
RMS reverse voltage		$V_{R(RMS)}$			21	V
Average forward rectified current		$I_o$			200	mA
Repetitive peak forward current		$I_{FRM}$			0.5	A
Forward current,surge peak	8.3 ms single half sine-wave superimposed on rate load(JEDEC method)	$I_{FSM}$			4	A
Power Dissipation		$P_D$			200	mW
Thermal resistance junction to ambient air		$R_{\theta JA}$			500	°C/W
Storage temperature		$T_{STG}$	-55		+125	°C
Junction temperature		$T_j$			+125	°C

### Electrical Characteristics (at TA=25°C unless otherwise noted)

Parameter	Conditions	Symbol	Min	Typ	Max	Unit
Forward voltage	CDBF42/43-HF CDBF42-HF CDBF42-HF CDBF43-HF CDBF43-HF	$V_F$			1 0.4 0.65 0.33 0.45	V
Reverse current	$V_R = 25V$	$I_R$			0.5	uA
Capacitance between terminals	$f = 1 \text{ MHz}$ , and 1 VDC reverse voltage	$C_T$			10	pF
Reverse recovery time	$I_F = I_R = 10 \text{ mA}$ , $I_{rr} = 0.1 \times I_R$ , $R_L = 100 \text{ ohm}$	$T_{rr}$			5	nS

# SMD Schottky Barrier Diode



## RATING AND CHARACTERISTIC CURVES (CDBF42/43-HF)

Fig. 1 - Forward characteristics

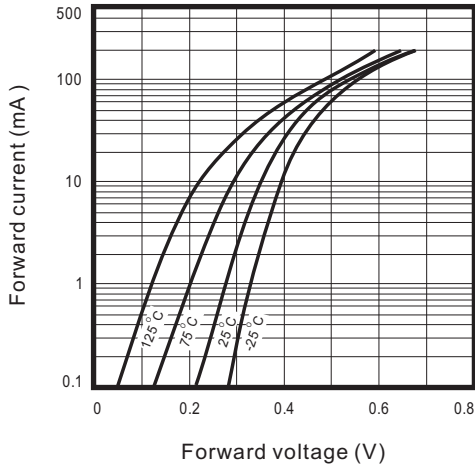

Fig. 2 - Reverse characteristics

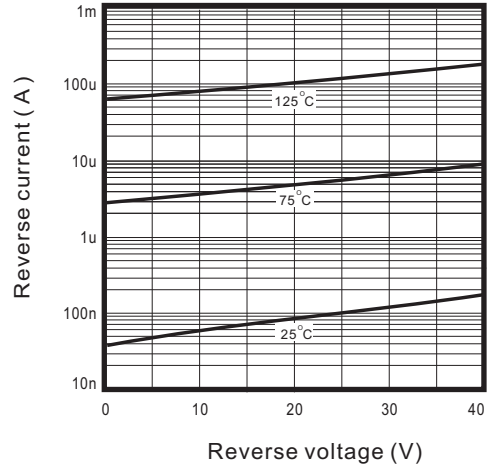

Fig.3 - Capacitance between terminals characteristics

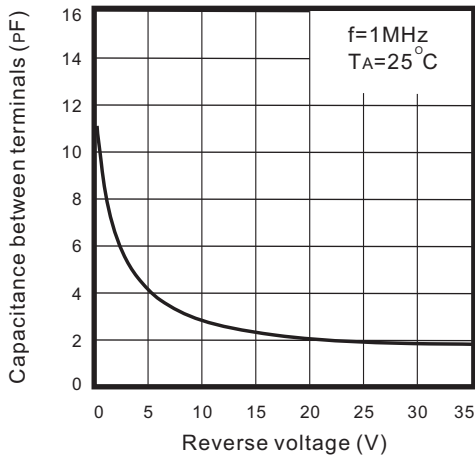
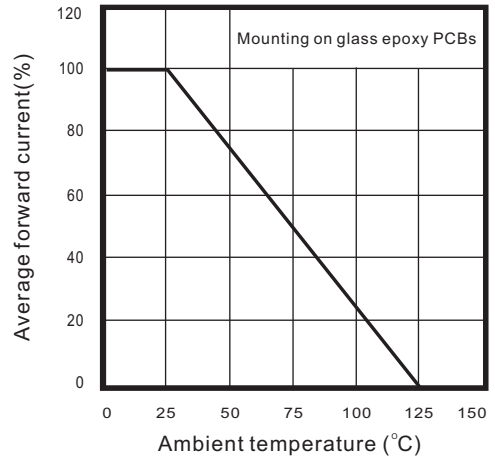

Fig.4 - Current derating curve



# SMD Schottky Barrier Diode



## Reel Taping Specification

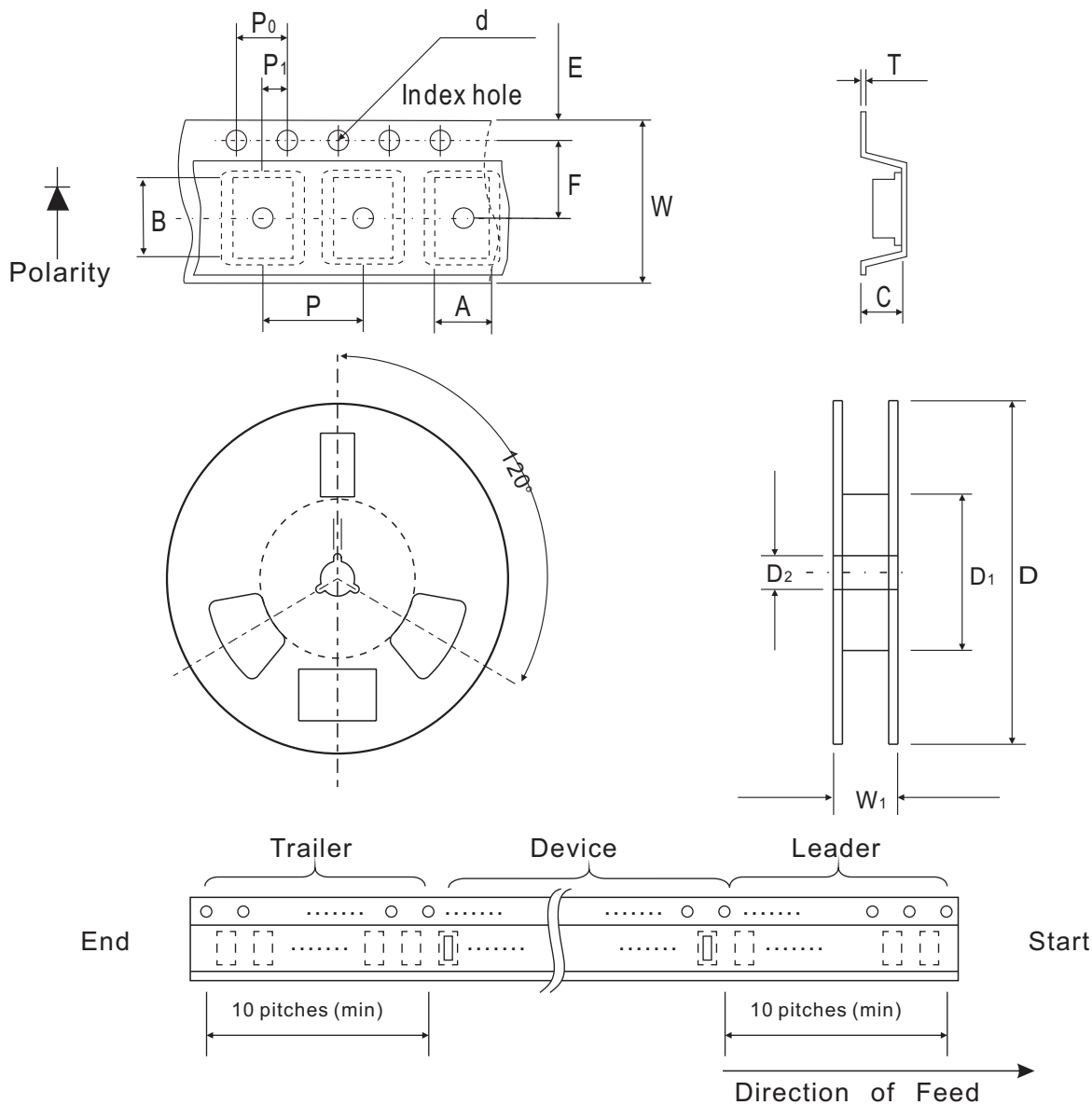

1005 (SOD-323F)	SYMBOL	A	B	C	d	D	D <sub>1</sub>	D <sub>2</sub>
	(mm)	1.55 ± 0.10	2.65 ± 0.10	1.05 ± 0.10	1.55 ± 0.05	178 ± 1	60.0 MIN.	13.0 ± 0.20
	(inch)	0.061 ± 0.004	0.104 ± 0.004	0.041 ± 0.004	0.061 ± 0.002	7.008 ± 0.04	2.362 MIN.	0.512 ± 0.008

1005 (SOD-323F)	SYMBOL	E	F	P	P <sub>0</sub>	P <sub>1</sub>	T	W	W <sub>1</sub>
	(mm)	1.75 ± 0.10	3.50 ± 0.05	4.00 ± 0.10	4.00 ± 0.10	2.00 ± 0.05	0.23 ± 0.05	8.00 ± 0.20	13.5 MAX.
	(inch)	0.069 ± 0.004	0.138 ± 0.002	0.157 ± 0.004	0.157 ± 0.004	0.079 ± 0.004	0.009 ± 0.002	0.315 ± 0.008	0.531 MAX.

# SMD Schottky Barrier Diode



## Marking Code

Park Number	Marking Code
CDBF42-HF	BD
CDBF43-HF	BE



xx = Product type marking code

## Suggested PAD Layout

SIZE	1005/SOD-323F	
	(mm)	(inch)
A	2.10	0.083
B	1.20	0.047
C	1.20	0.047
D	3.30	0.130
E	0.90	0.035

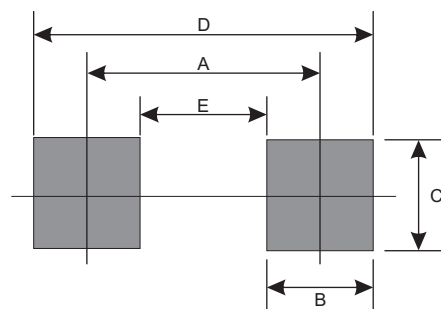

## Standard Package

Case Type	Qty per Reel	Reel Size
	(Pcs)	(inch)
1005/SOD-323F	4000	7