

Excellent Integrated System Limited

Stocking Distributor

Click to view price, real time Inventory, Delivery & Lifecycle Information:

[Comchip Technology](#)

[CDBMH1100-HF](#)

For any questions, you can email us directly:

sales@integrated-circuit.com

SMD Schottky Barrier Rectifiers



CDBMH120-HF Thru. CDBMH1150-HF

Reverse Voltage: 20 to 150 Volts

Forward Current: 1.0 Amp

RoHS Device

Halogen Free

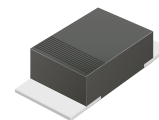

Features

- Batch process design, excellent power dissipation offers better reverse leakage current and thermal resistance.
- Low profile surface mounted application in order to optimize board space.
- Low power loss, high efficiency.
- High current capability, low forward voltage drop.
- High surge capability.
- Guardring for overvoltage protection.
- Ultra high-speed switching.
- Silicon epitaxial planar chip, metal silicon junction.
- Heat sink bottom.
- Lead-free parts meet environmental standards of MIL-STD-19500/228

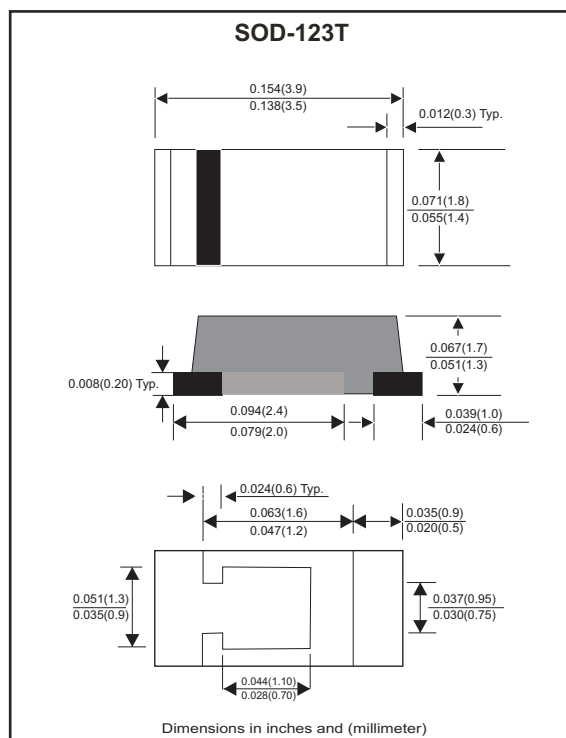

Mechanical data

- Case: Molded plastic, SOD-123T/Mini SMA.
- Terminals: Solderable per MIL-STD-750, method 2026.
- Polarity: Indicated by cathode band.
- Weight: 0.018 grams approx.

Maximum Ratings (at $T_A=25^\circ\text{C}$ unless otherwise noted)

Parameter	Symbol	CDBMH 120-HF	CDBMH 130-HF	CDBMH 140-HF	CDBMH 150-HF	CDBMH 160-HF	CDBMH 180-HF	CDBMH 1100-HF	CDBMH 1150-HF	Unit	
Max. Repetitive peak reverse voltage	V_{RRM}	20	30	40	50	60	80	100	150	V	
Max. Continuous reverse voltage	V_R	20	30	40	50	60	80	100	150	V	
Max. RMS voltage	V_{RMS}	14	21	28	35	42	56	70	105	V	
Max. averaged forward current (see fig.1)	I_o	1.0								A	
Maximum Instantaneous forward voltage at $I_F=1.0A$	V_F	0.50			0.70		0.85		0.92	V	
Max. Forward surge current, 8.3ms single half sine-wave superimposed on rated load (JEDEC method)	I_{FSM}	30								A	
Max.Reverse current	$V_R=V_{RRM}$ $T_J=25^\circ\text{C}$	0.2								mA	
	$V_R=V_{RRM}$ $T_J=100^\circ\text{C}$	10									
Typ. Thermal resistance (Junction to case)	$R_{\theta JC}$	45								$^\circ\text{C/W}$	
Typ. Diode Junction capacitance (Note 1)	C_J	120								pF	
Operating temperature	T_J	-55 to +125				-55 to +150					$^\circ\text{C}$
Storage temperature range	T_{STG}	-65 to +175								$^\circ\text{C}$	

Note : 1. F=1MHz and applied 4V DC reverse voltage

SMD Schottky Barrier Rectifiers



Rating and Characteristic Curves (CDBMH120-HF Thru. CDBMH1150-HF)

Fig.1- Typical Current Derating Curve

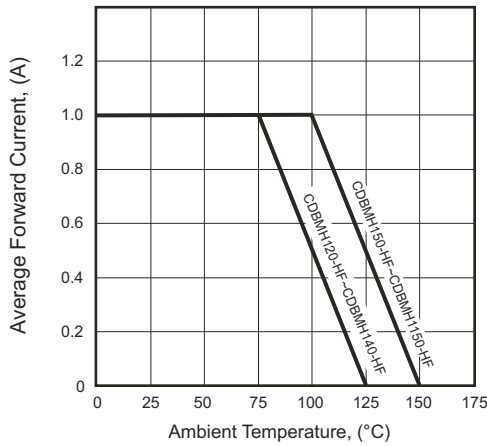

Fig.2 - Typical Forward Characteristics

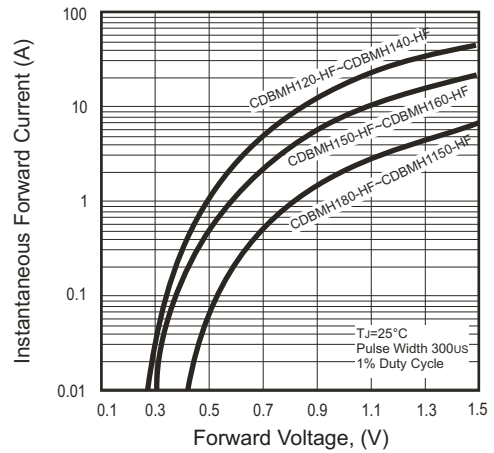

Fig.3 - Maximum Non-repetitive Forward Surge Current

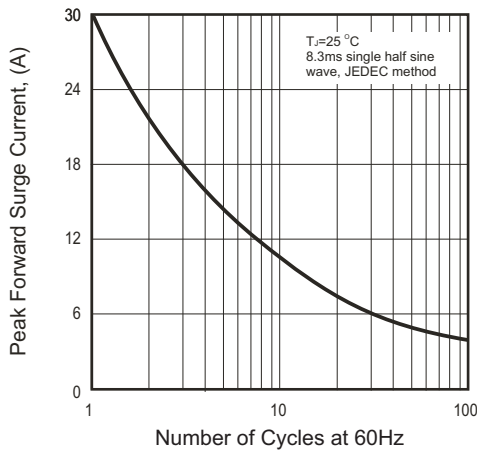

Fig.4 - Typical Junction Capacitance

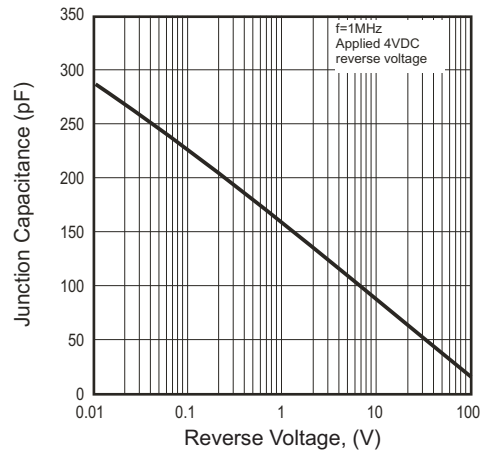
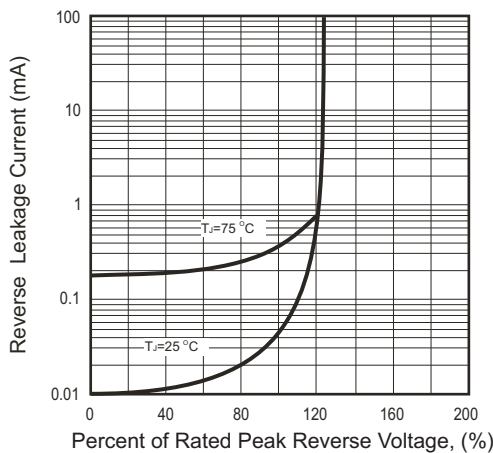

Fig.5 - Typical Reverse Characteristics



SMD Schottky Barrier Rectifiers



Reel Taping Specification

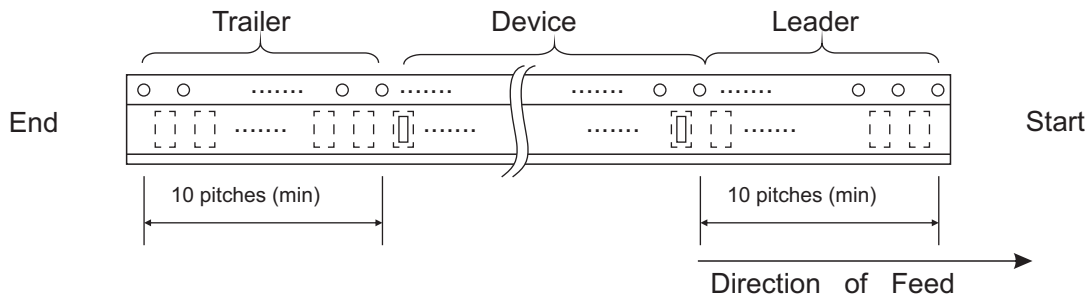
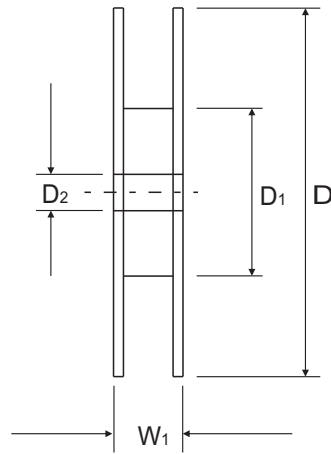
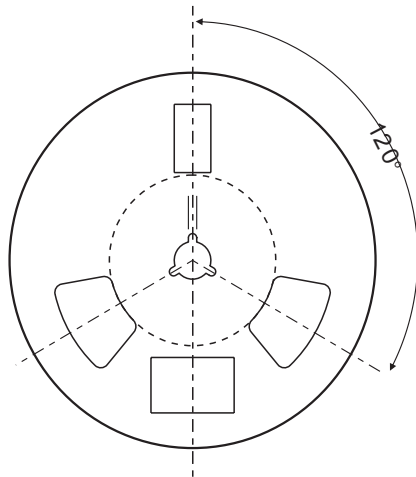
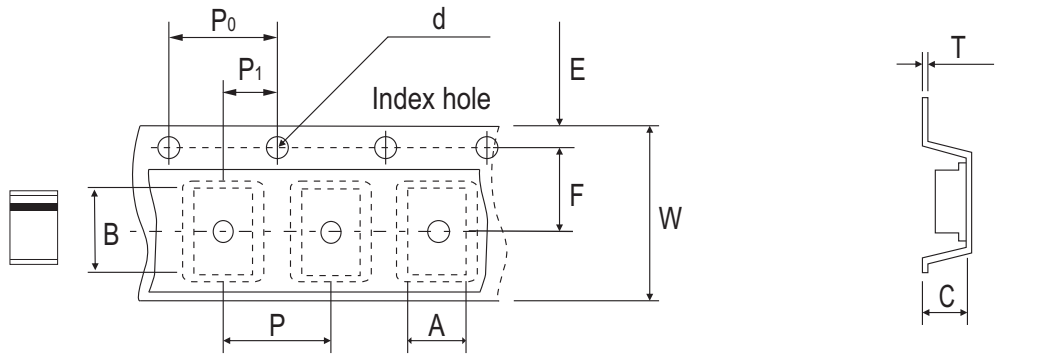



	SYMBOL	A	B	C	d	D	D1	D2
Mini-SMA/SOD-123T	(mm)	1.90 ± 0.10	3.90 ± 0.10	1.68 ± 0.10	1.50 ± 0.10	178 ± 2.00	62.0 MIN.	13.0 ± 0.50
	(inch)	0.075 ± 0.04	0.153 ± 0.04	0.066 ± 0.04	0.059 ± 0.004	7.008 ± 0.079	2.440 MIN.	0.512 ± 0.020

	SYMBOL	E	F	P	P0	P1	T	W	W1
Mini-SMA/SOD-123T	(mm)	1.75 ± 0.10	3.50 ± 0.10	4.00 ± 0.10	4.00 ± 0.10	2.00 ± 0.10	0.23 ± 0.10	8.00 ± 0.30	11.40 ± 1.0
	(inch)	0.069 ± 0.004	0.138 ± 0.004	0.157 ± 0.004	0.157 ± 0.004	0.079 ± 0.004	0.009 ± 0.004	0.314 ± 0.012	0.449 ± 0.039

SMD Schottky Barrier Rectifiers

Pinning information

Pin	Simplified outline	Symbol
PIN 1 Cathode PIN 2 Anode		

Marking Code

Part Number	Marking Code
CDBMH120-HF	12
CDBMH130-HF	13
CDBMH140-HF	14
CDBMH150-HF	15
CDBMH160-HF	16
CDBMH180-HF	18
CDBMH1100-HF	10
CDBMH1150-HF	115



xx / xxx = Product type marking code

Suggested PAD Layout

SIZE	Mini-SMA/SOD-123T	
	(mm)	(inch)
A	1.00	0.040
B	1.00	0.040
C	1.70	0.067
D	0.50	0.020
E	1.50	0.060
F	1.10	0.044
G	0.90	0.035
H	0.85	0.033
I	0.60	0.024

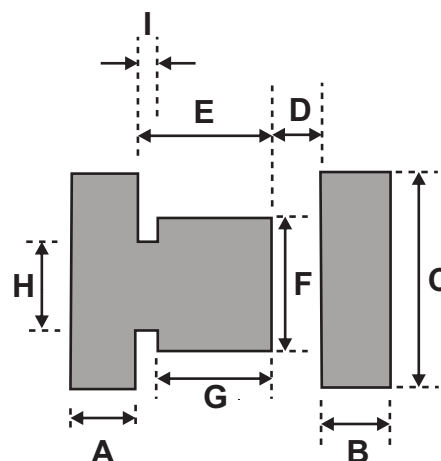

Standard Packaging

Case Type	REEL PACK	
	REEL (pcs)	Reel Size (inch)
Mini-SMA /SOD-123T	2,500	7