

Excellent Integrated System Limited

Stocking Distributor

Click to view price, real time Inventory, Delivery & Lifecycle Information:

[Comchip Technology](#)
[CDSV4148-G](#)

For any questions, you can email us directly:

sales@integrated-circuit.com

SMD Switching Diode



CDSV4148-G

RoHS Device

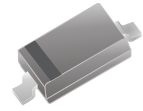

Features

- Fast Switching Speed
- High Conductance
- Surface Mount Package Ideally Suited for Automatic Insertion
- For General Purpose Switching Applications.

Mechanical data

- Case: SOD-323, Molded Plastic
- Terminals: Solderable per MIL-STD-202, Method208
- Mounting position: Any.

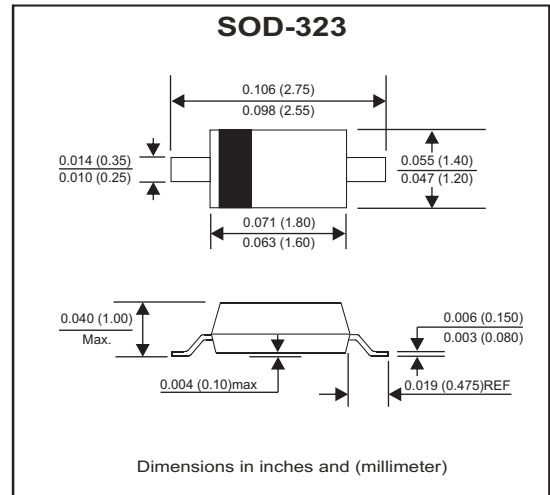

Circuit Diagram



Maximum Ratings (at TA=25°C unless otherwise noted)

Parameter	Symbol	Value	Unit
Non-Repetitive peak reverse voltage	V _{RM}	100	V
Peak repetitive peak reverse voltage	V _{RRM}	100	V
Working peak reverse voltage	V _{RWM}		
DC blocking voltage	V _R		
RMS reverse voltage	V _{R(RMS)}	71	V
Forward continuous current	I _{FM}	300	mA
Average rectified output current	I _o	150	mA
Non-Repetitive peak forward surge current @ t=8.3ms	I _{FSM}	2.0	A
Power dissipation	P _D	200	mW
Thermal resistance from junction to ambient	R _{θJA}	625	°C/W
Junction temperature range	T _j	-40 ~ +150	°C
Storage temperature range	T _{STG}	-55 ~ +150	°C

Electrical Characteristics (at TA=25°C unless otherwise noted)

Parameter	Conditions	Symbol	Min	Typ	Max	Unit
Forward voltage	I _{F1} = 1mA I _{F2} = 10mA I _{F3} = 50mA I _{F4} = 150mA	V _F			0.715 0.855 1.0 1.25	V
Reverse current	V _R = 75 V V _R = 20 V	I _R			1 25	μA nA
Capacitance between terminals	V _R = 0V, f = 1MHz	C _T			2	pF
Reverse recovery time	I _F = I _R = 10mA, R _L = 100 Ω, I _{rr} = 0.1 X I _R	T _{RR}			4	nS

SMD Switching Diode



PATING AND CHARACTERISTIC CURVES (CDSV4148-G)

Fig.1 - Forward Characteristics

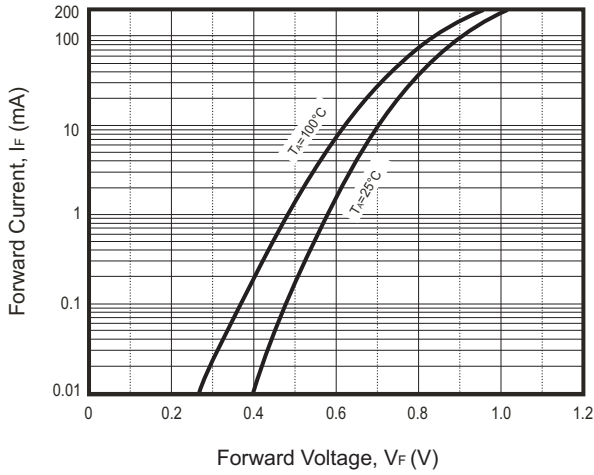

Fig.2 - Reverse Characteristics

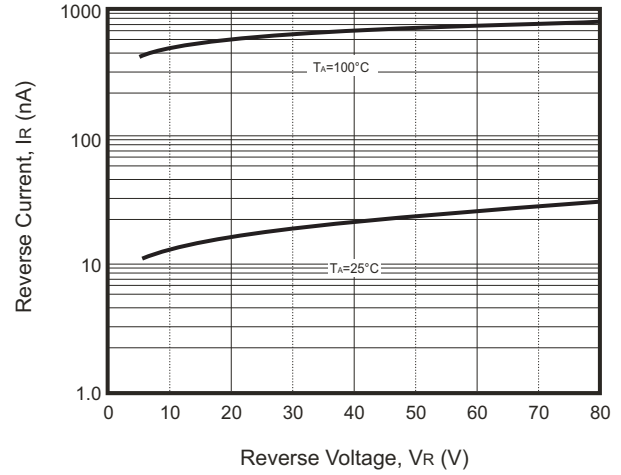

Fig.3 - Capacitance Characteristics

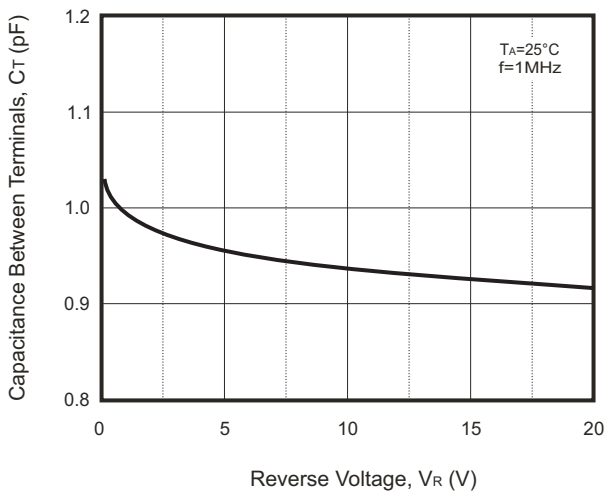
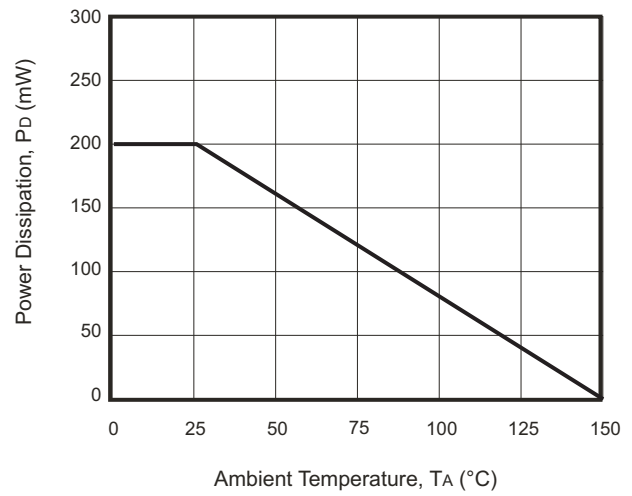

Fig.4 - Power Derating Curve



SMD Switching Diode



Reel Taping Specification

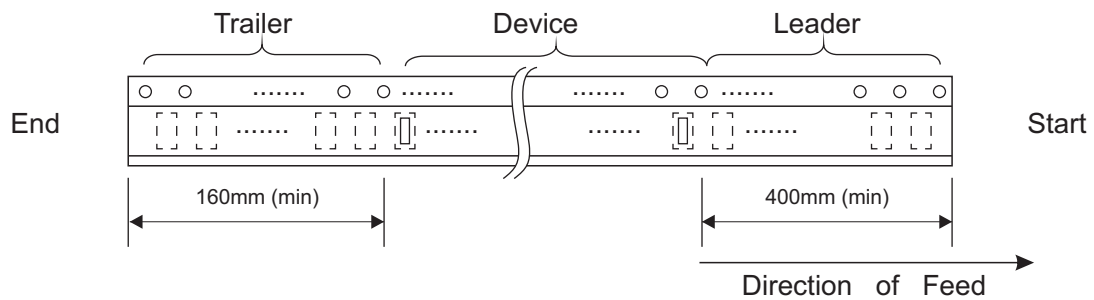
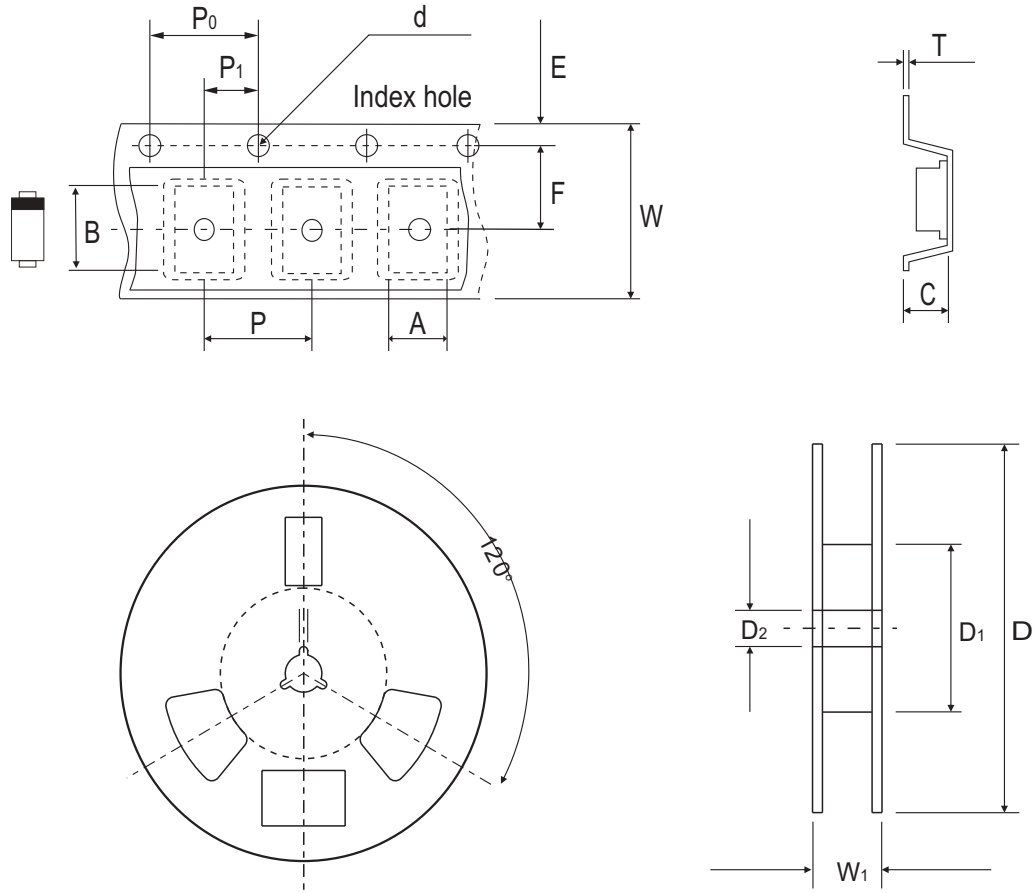

SOD-323	SYMBOL	A	B	C	d	D	D1	D2
	(mm)	1.46 ± 0.05	2.90 ± 0.05	1.25 ± 0.05	1.50 + 0.10	178.00 ± 2.00	54.40 ± 1.00	13.00 ± 1.00
	(inch)	0.057 ± 0.002	0.114 ± 0.002	0.049 ± 0.002	0.059 + 0.004	7.008 ± 0.079	2.142 ± 0.039	0.512 ± 0.039

SOD-323	SYMBOL	E	F	P	P0	P1	W	W1
	(mm)	1.75 ± 0.10	3.50 ± 0.10	4.00 ± 0.10	4.00 ± 0.10	2.00 ± 0.10	8.00 + 0.30 / - 0.10	12.30 ± 1.00
	(inch)	0.069 ± 0.004	0.138 ± 0.004	0.158 ± 0.004	0.158 ± 0.004	0.079 ± 0.004	0.315 + 0.012 / - 0.004	0.484 ± 0.039

SMD Switching Diode

Marking Code

Part Number	Marking Code
CDSV4148-G	T4



Suggested PAD Layout

SIZE	SOD-323	
	(mm)	(inch)
A	2.15	0.085
B	0.80	0.031
C	0.70	0.028
D	2.95	0.116
E	1.35	0.053

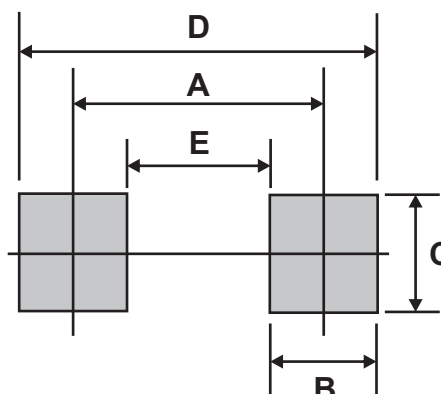

Standard Packaging

Case Type	REEL PACK	
	REEL (pcs)	Reel Size (inch)
SOD-323	3,000	7