

Excellent Integrated System Limited

Stocking Distributor

Click to view price, real time Inventory, Delivery & Lifecycle Information:

[Comchip Technology](#)

[CPDF5V0U-HF](#)

For any questions, you can email us directly:

sales@integrated-circuit.com

SMD ESD Protection Diode



CPDF5V0U-HF

RoHS Device
 Halogen Free

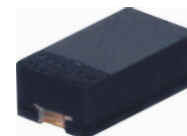

Features

- Uni-directional ESD protection.
- IEC 61000-4-2 (ESD) ; ± 30 KV(contact)
- Working voltage: 5V
- Surface mount package.
- High component density.

Mechanical data

- Case: 1005/SOD-323F standard package , molded plastic.
- Terminals: Gold plated, solderable per MIL-STD-750, method 2026.
- Mounting position: Any.
- Weight: 0.006 grams(approx.).

Circuit Diagram

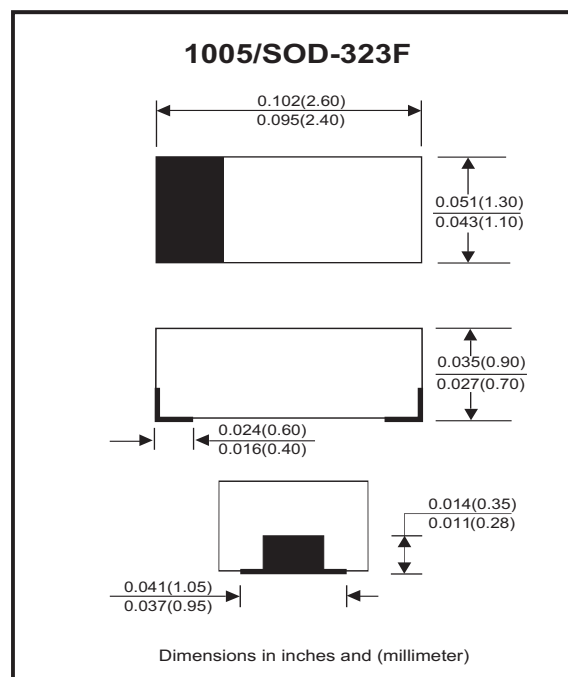

Maximum Rating (at $T_A=25^\circ\text{C}$ unless otherwise noted)

Parameter	Conditions	Symbol	Value	Unit
Peak pulse power	$T_P = 8/20\mu\text{s}$	P_{PP}	180	W
Peak pulse current	$T_P = 8/20\mu\text{s}$	I_{PP}	15	A
ESD capability	IEC 61000-4-2(air)	ESD	± 30	kV
	IEC 61000-4-2(contact)	ESD	± 30	
Operation temperature range		T_j	$-40 \sim +125$	$^\circ\text{C}$
Storage temperature range		T_{STG}	$-55 \sim +150$	$^\circ\text{C}$

Electrical Characteristics (at $T_A=25^\circ\text{C}$ unless otherwise noted)

Parameter	Conditions	Symbol	Min	Typ	Max	Unit
Working peak reverse voltage		V_{RWM}			5.0	V
Forward voltage	$I_F = 10\text{mA}$	V_F		0.8	1.2	V
Breakdown voltage	$I_T = 1\text{mA}$	V_{BR}	6			V
Reverse leakage current	$V_{RWM} = 5\text{V}$	I_R		0.2	2.0	μA
Clamping voltage	$I_{PP} = 1\text{A}, T_P = 8/20\mu\text{s}$	V_C		8	7.6	V
	$I_{PP} = 5\text{A}, T_P = 8/20\mu\text{s}$			10	9.4	
	$I_{PP} = 15\text{A}, T_P = 8/20\mu\text{s}$				12	
Junction capacitance	$V_R = 0\text{V}, f = 1\text{MHz}$	C_J		130		pF

SMD ESD Protection Diode



RATING AND CHARACTERISTIC CURVES (CPDF5V0U-HF)

Fig.1- 8/20us Peak Pulse Current Wave Form Acc. IEC 61000-4-5

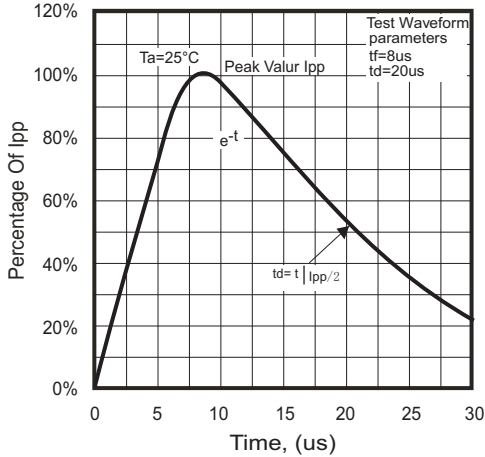

Fig.2 - Power Rating Derating Curve

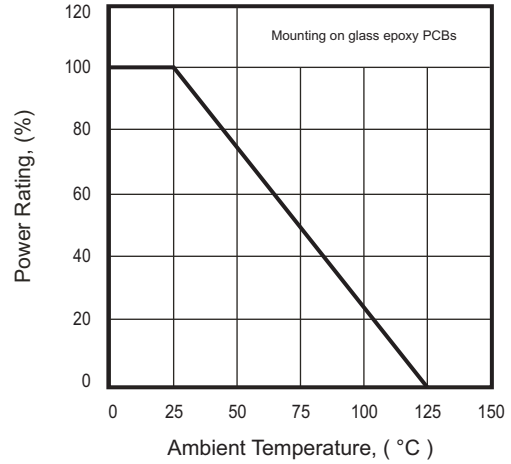

Fig.3 - Clamping Voltage Vs. Peak Pulse Current

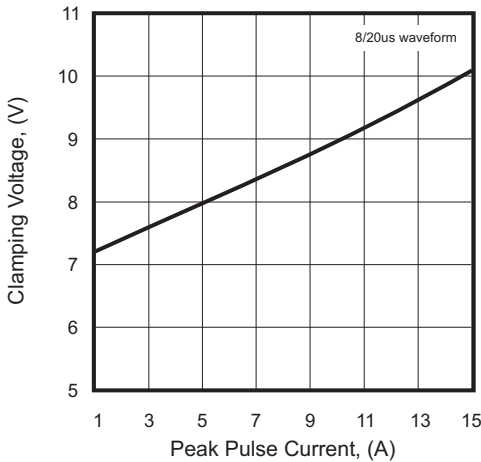

Fig.4 - Forward Characteristic

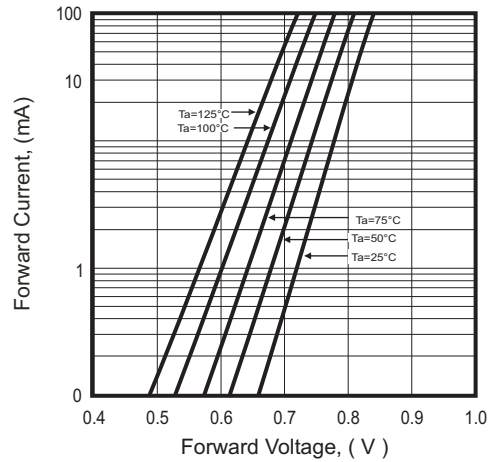
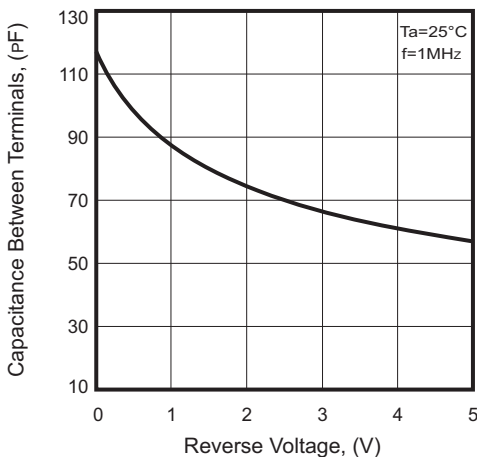

Fig.5 - Capacitance Between Terminals Characteristics



SMD ESD Protection Diode



Reel Taping Specification

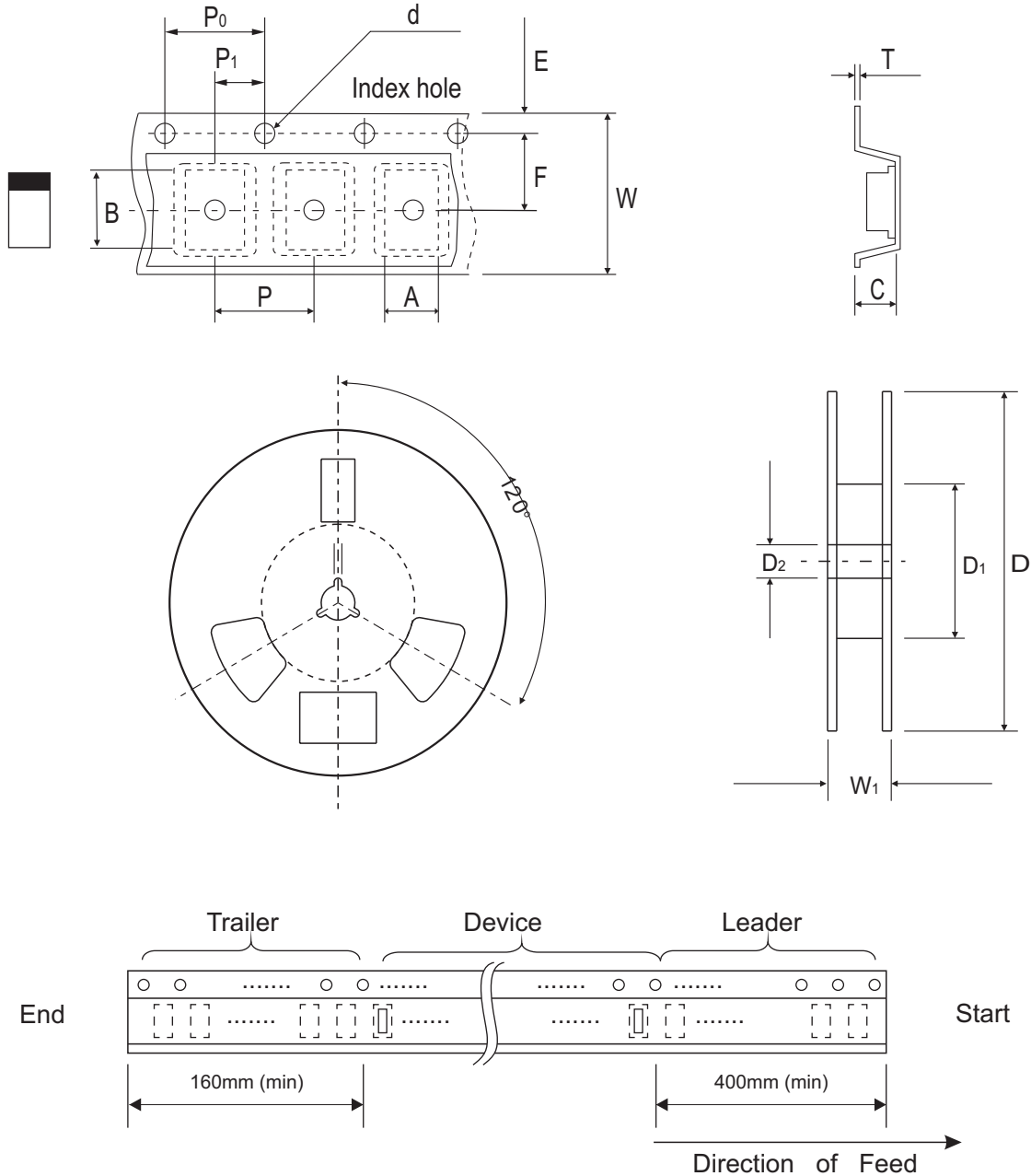

1005 (SOD-323F)	SYMBOL	A	B	C	d	D	D ₁	D ₂
	(mm)	1.45 ± 0.05	2.80 ± 0.05	1.00 ± 0.05	1.50 + 0.10 - 0	178.00 ± 1.00	60.00 ± 0.50	13.50 ± 0.20
	(inch)	0.057 ± 0.002	0.110 ± 0.002	0.039 ± 0.002	0.059 + 0.004 - 0	7.008 ± 0.039	2.362 ± 0.020	0.531 ± 0.008

1005 (SOD-323F)	SYMBOL	E	F	P	P ₀	P ₁	T	W	W ₁
	(mm)	1.75 ± 0.10	3.50 ± 0.05	4.00 ± 0.10	4.00 ± 0.10	2.00 ± 0.05	0.23 ± 0.05	8.00 ± 0.10	12.00 + 0.50 - 0
	(inch)	0.069 ± 0.004	0.138 ± 0.002	0.157 ± 0.004	0.157 ± 0.004	0.079 ± 0.002	0.009 ± 0.002	0.315 ± 0.004	0.472 + 0.020 - 0

SMD ESD Protection Diode

Marking Code

Part Number	Marking Code
CPDF5V0U-HF	E05



Suggested PAD Layout

SIZE	1005/SOD-323F	
	(mm)	(inch)
A	2.10	0.083
B	1.20	0.047
C	1.20	0.047
D	3.30	0.130
E	0.90	0.035

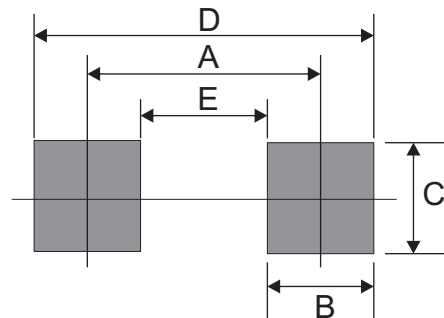

Standard Packaging

Case Type	Qty Per Reel	Reel Size
	(Pcs)	(inch)
1005/SOD-323F	4,000	7