

Excellent Integrated System Limited

Stocking Distributor

Click to view price, real time Inventory, Delivery & Lifecycle Information:

[Comchip Technology](#)

[CPDQR12V-HF](#)

For any questions, you can email us directly:

sales@integrated-circuit.com

SMD ESD Protection Diode



CPDQR12V-HF

RoHS Device

Halogen Free

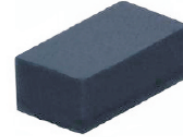

Features

- Bi-directional ESD protection.
- Surface mount package.
- Ultra small SMD package:0402.
- High component density.

Mechanical data

- Case: 0402/SOD-923F standard package, molded plastic.
- Terminals: Gold plated, solderable per MIL-STD-750,method 2026.
- Marking Code:
CPDQR12V-HF: E2
- Mounting position: Any.
- Weight: 0.001 grams(approx.).

Circuit Diagram

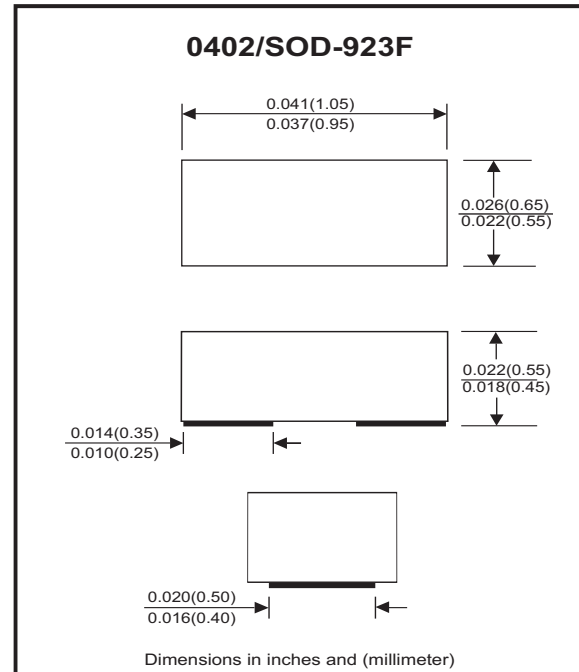

Electrical Characteristics (at TA=25°C unless otherwise noted)

Parameter	Conditions	Symbol	Min	Typ	Max	Unit
Diode breakdown voltage	I _R = 1mA	V _{BD}	13	17		V
Leakage current	V _R = 12V	I _L		0.1	2.0	uA
Junction capacitance	V _R = 0V, f = 1MHz	C _T		12		pF
ESD capability	IEC 61000-4-2(air) IEC 61000-4-2(contact)	ESD			16 8	kV
Clamping voltage	I _{PP} = 1A, T _P =8/20us	V _C			25	V
Peak pulse power	T _P =8/20us	P _{PP}			25	W
Operation temperature range		T _J	-40		125	°C
Storage temperature range		T _{STG}	-55		150	°C

SMD ESD Protection Diode



RATING AND CHARACTERISTIC CURVES (CPDQR12V-HF)

Fig.1 - 8/20us Peak Pulse Current Wave Form Acc. IEC 61000-4-5

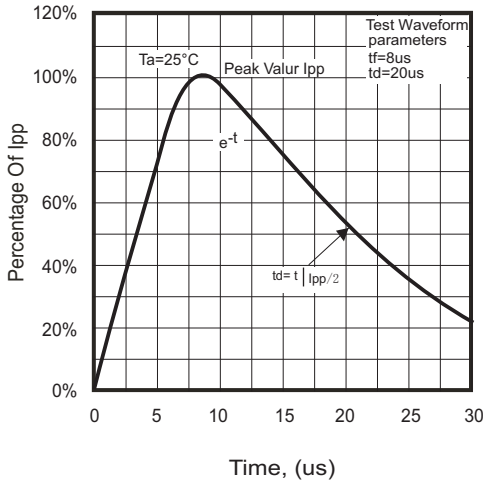

Fig.2 - Reverse Characteristics

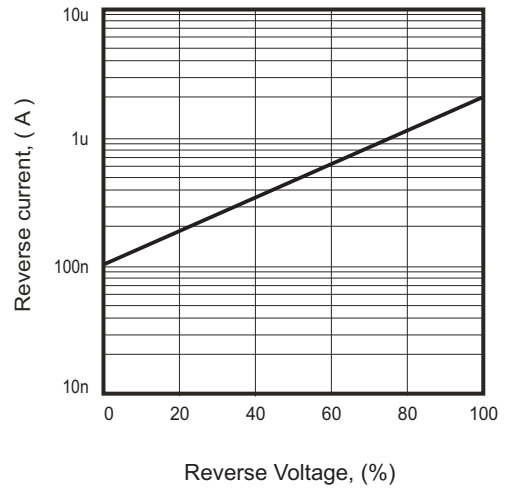

Fig.3 - Capacitance Between Terminals Characteristics

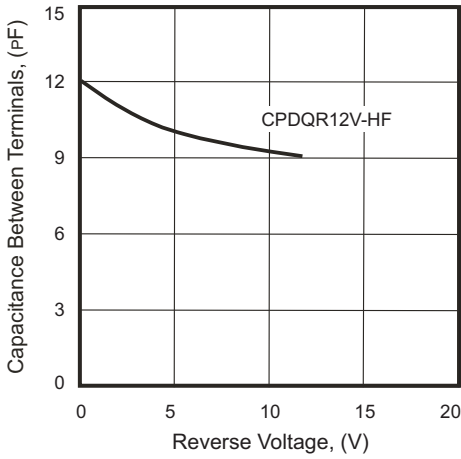
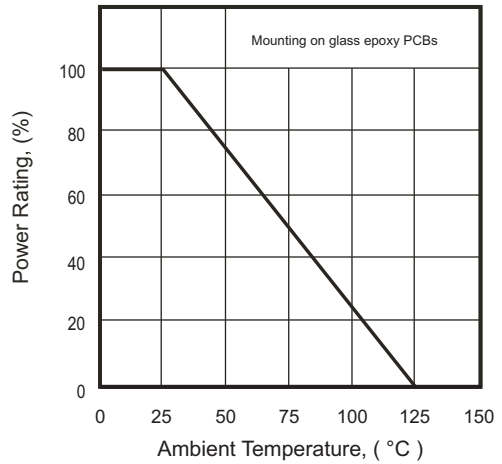

Fig.4 - Power Rating Derating Curve



SMD ESD Protection Diode



Reel Taping Specification

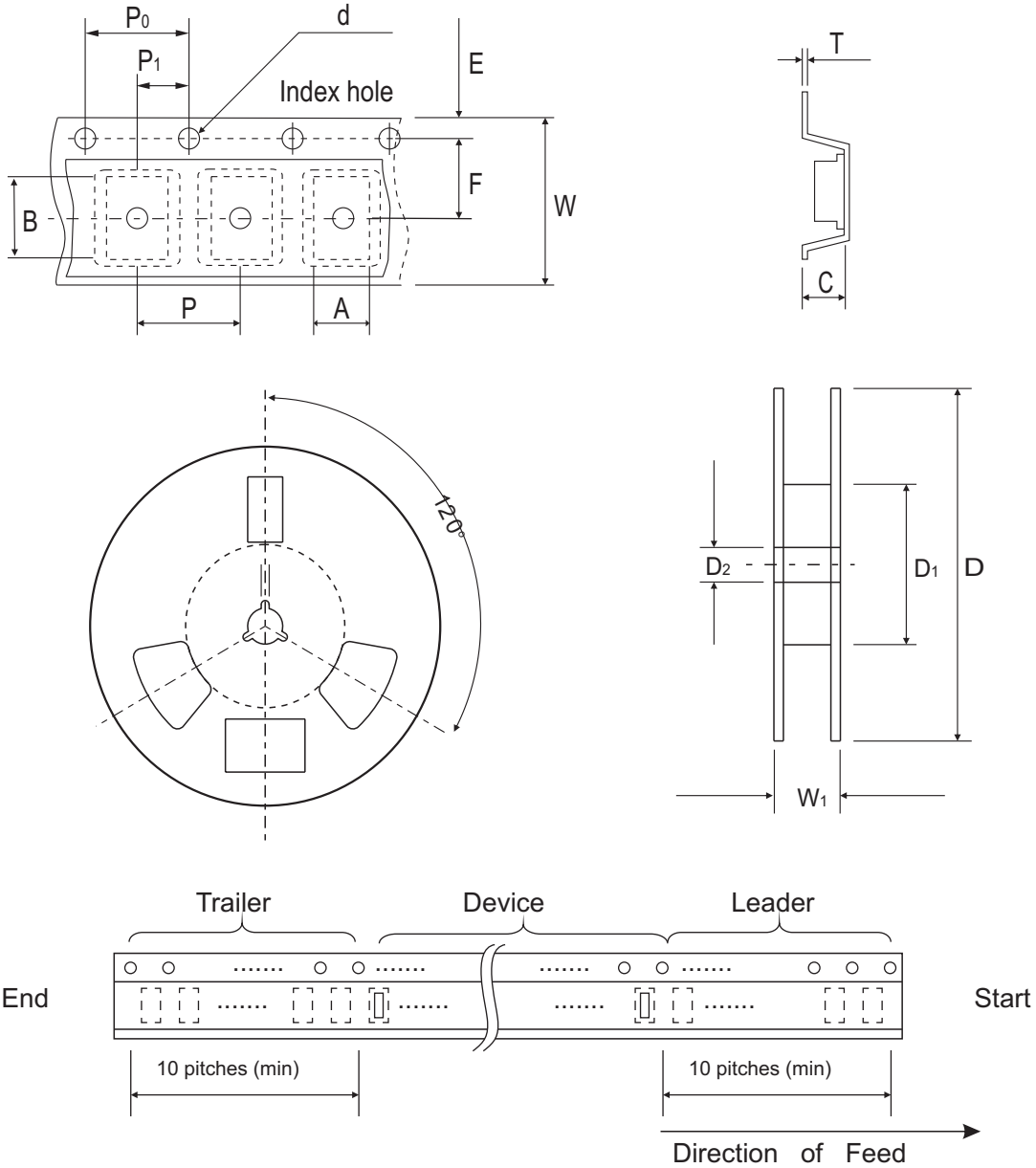

0402 (SOD-923F)	SYMBOL	A	B	C	d	D	D ₁	D ₂
	(mm)	0.75 ± 0.10	1.15 ± 0.10	0.60 ± 0.10	1.55 ± 0.10	178 ± 1	60.0 MIN.	13.0 ± 0.20
	(inch)	0.030 ± 0.004	0.045 ± 0.004	0.024 ± 0.004	0.061 ± 0.004	7.008 ± 0.040	2.362 MIN.	0.512 ± 0.008

0402 (SOD-923F)	SYMBOL	E	F	P	P ₀	P ₁	T	W	W ₁
	(mm)	1.75 ± 0.10	3.50 ± 0.05	4.00 ± 0.10	4.00 ± 0.10	2.00 ± 0.10	0.22 ± 0.05	8.00 ± 0.20	13.5 MAX.
	(inch)	0.069 ± 0.004	0.138 ± 0.002	0.157 ± 0.004	0.157 ± 0.004	0.079 ± 0.004	0.009 ± 0.002	0.315 ± 0.008	0.531 MAX.

SMD ESD Protection Diode

Marking Code

Part Number	Marking Code
CPDQR12V-HF	E2



xx = Product type marking code

Suggested PAD Layout

SIZE	0402/SOD-923F	
	(mm)	(inch)
A	0.75	0.030
B	0.50	0.020
C	0.70	0.028
D	1.25	0.049
E	0.25	0.010

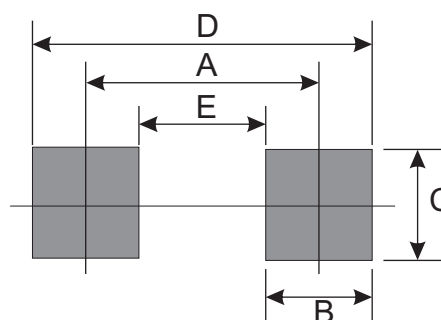

Standard Packaging

Case Type	Qty Per Reel	Reel Size
	(Pcs)	(inch)
0402/SOD-923F	5,000	7