

Excellent Integrated System Limited

Stocking Distributor

Click to view price, real time Inventory, Delivery & Lifecycle Information:

[Comchip Technology](#)
[CPDQR5V0C-HF](#)

For any questions, you can email us directly:

sales@integrated-circuit.com

SMD ESD Protection Diode



CPDQR5V0C-HF

RoHS Device
 Halogen Free

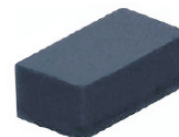

Features

- Bi-directional ESD protection.
- Surface mount package.
- Ultra small SMD package:0402.
- Operating voltage: 5V.

Mechanical data

- Case: 0402(1005) standard package, molded plastic.
- Terminals: Gold plated, solderable per MIL-STD-750,method 2026.
- Marking Code:
 CPDQR5V0C: E5
- Mounting position: Any.
- Weight: 0.001 grams(approx.).

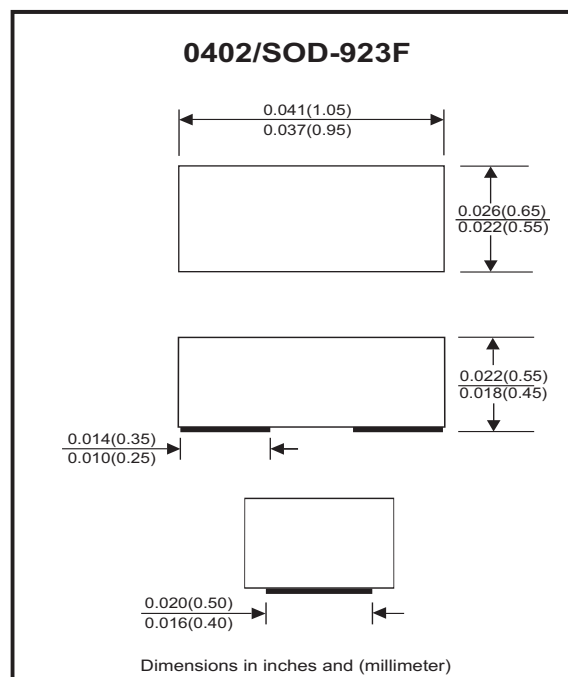

Circuit Diagram



Electrical Characteristics (at TA=25°C unless otherwise noted)

Parameter	Conditions	Symbol	Min	Typ	Max	Unit
Diode breakdown voltage	IR = 1mA	V _{BD}	6.1	7.0		V
Leakage current	V _R = 5V	I _L		0.1	2.0	uA
Junction capacitance	V _R = 0V, f = 1MHz	C _T		25	30	pF
ESD capability	IEC 61000-4-2(air)	ESD			16	kV
	IEC 61000-4-2(contact)	ESD			8	kV
Clamping Voltage	I _{PP} = 1 A, tp=8/20us	V _c			10	V
	I _{PP} = 4 A, tp=8/20us	V _c			17	V
Peak Pulse Power	T _P =8/20us	PPP			68	W
Operation temperature range		T _j	-55		125	°C
Storage temperature range		T _{STG}	-55		150	°C

SMD ESD Protection Diode



RATING AND CHARACTERISTIC CURVES (CPDQR5V0C-HF)

Fig.1 - Reverse Characteristics

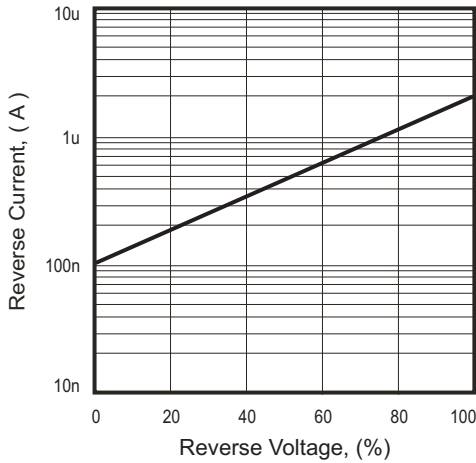

Fig.2 - Capacitance Between Terminals Characteristics

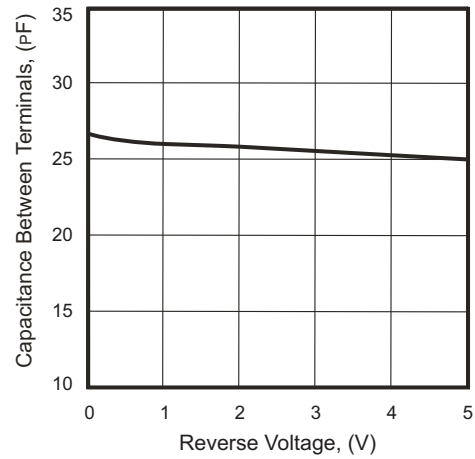

Fig.3 - Clamping Voltage Vs. Peak Pulse Current

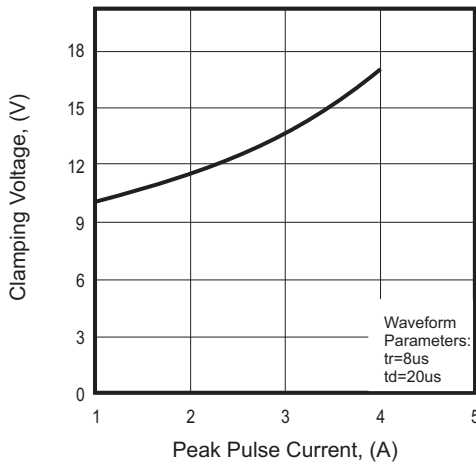
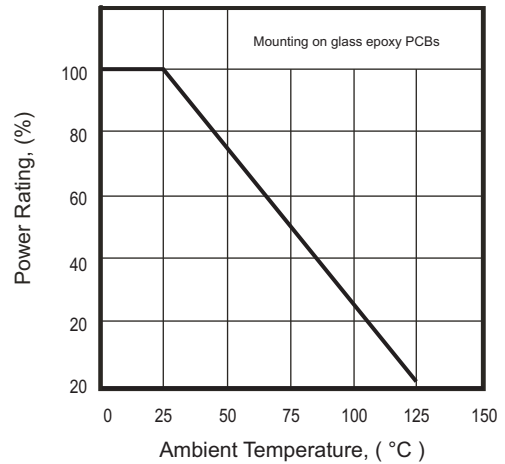

Fig.4 - Power Rating Derating Curve



SMD ESD Protection Diode



Reel Taping Specification

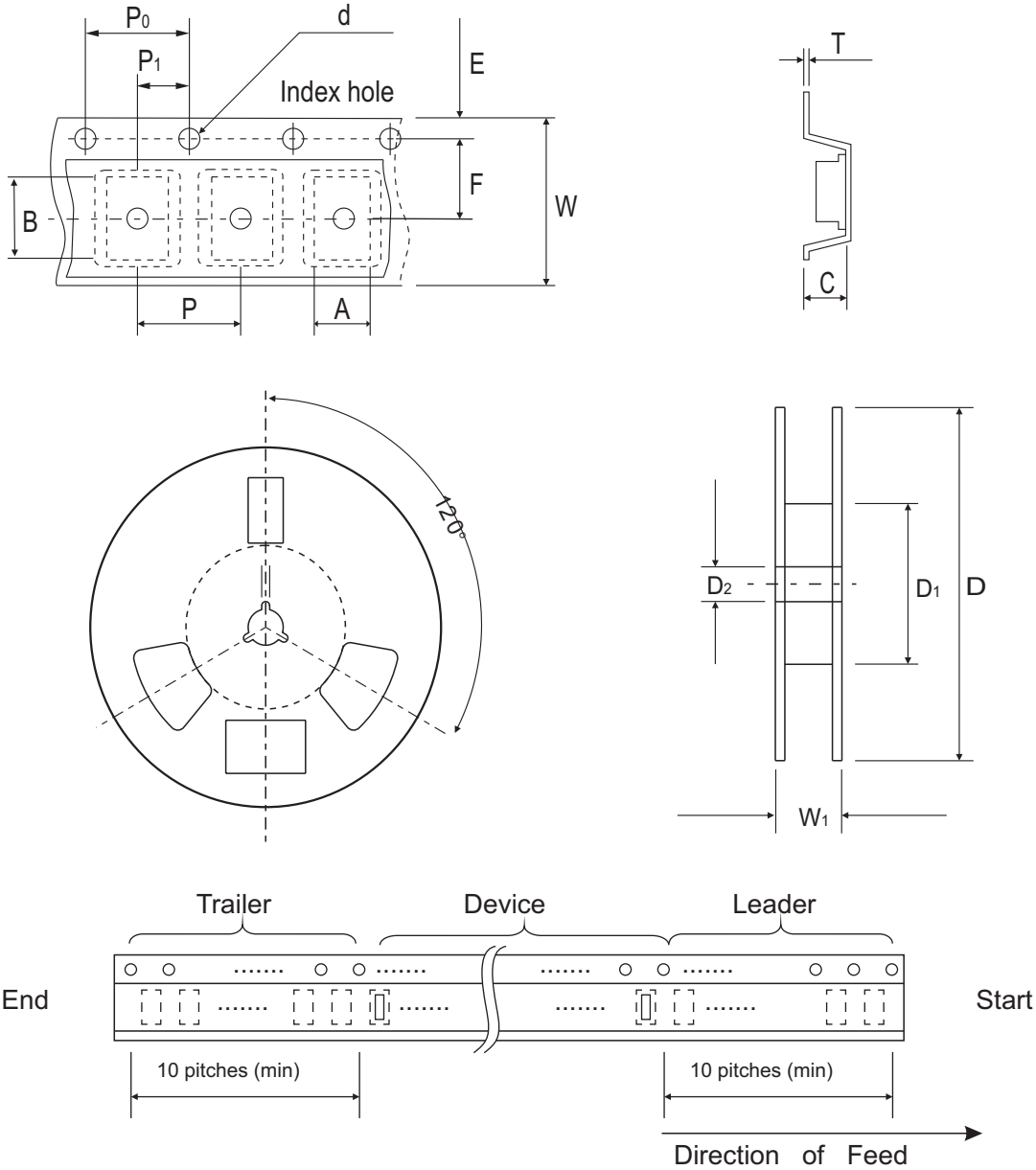

0402 (SOD-923F)	SYMBOL	A	B	C	d	D	D ₁	D ₂
	(mm)	0.75 ± 0.05	1.17 ± 0.05	0.65 ± 0.05	1.50 + 0.10 - 0	178 ± 1	60.0 + 0.50 - 0	13.0 ± 0.20
	(inch)	0.030 ± 0.002	0.046 ± 0.002	0.026 ± 0.002	0.059 + 0.004 - 0	7.008 ± 0.039	2.362 + 0.020 - 0	0.512 ± 0.008

0402 (SOD-923F)	SYMBOL	E	F	P	P ₀	P ₁	T	W	W ₁
	(mm)	1.75 ± 0.10	3.50 ± 0.10	4.00 ± 0.10	4.00 ± 0.10	2.00 ± 0.10	0.20 + 0.02 - 0.05	8.00 ± 0.20	12.0 ± 0.15
	(inch)	0.069 ± 0.004	0.138 ± 0.004	0.157 ± 0.004	0.157 ± 0.004	0.079 ± 0.004	0.008 + 0.001 - 0.002	0.315 ± 0.008	0.472 ± 0.006

SMD ESD Protection Diode



Marking Code

Part Number	Marking Code
CPDQR5V0C-HF	E5



Suggested PAD Layout

SIZE	0402/SOD-923F	
	(mm)	(inch)
A	0.750	0.030
B	0.500	0.020
C	0.700	0.028
D	1.250	0.049
E	0.250	0.010

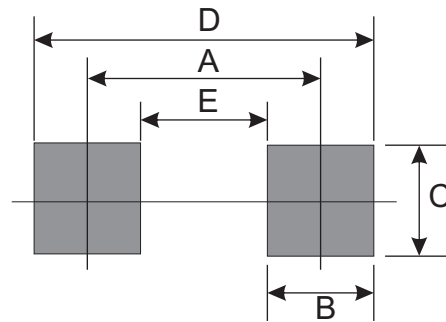

Standard Packaging

Case Type	Qty Per Reel	Reel Size
	(Pcs)	(inch)
0402/SOD-923F	5,000	7