

Excellent Integrated System Limited

Stocking Distributor

Click to view price, real time Inventory, Delivery & Lifecycle Information:

[Molex Connector Corporation](#)

[0026013096](#)

For any questions, you can email us directly:

sales@integrated-circuit.com

13 12 11 10 9 8 7 6 5 4 3 2 1

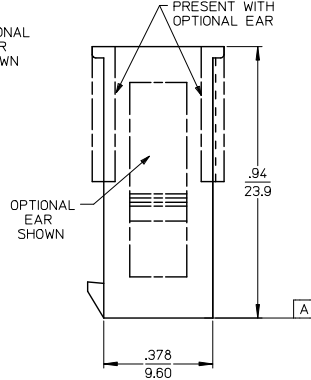
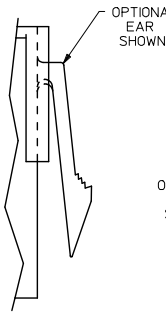
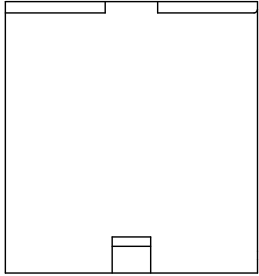
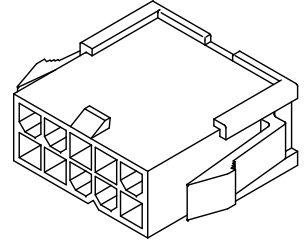
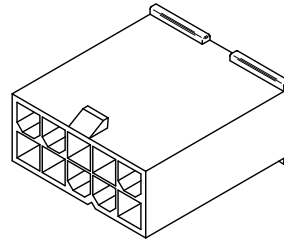
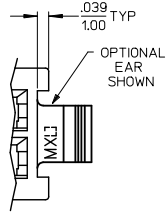
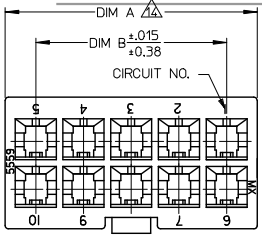

WITHOUT MOUNTING EARS
6-24 CIRCUIT
5559-**P1-225

WITH MOUNTING EARS
2-24 CIRCUIT
5559-**P-225

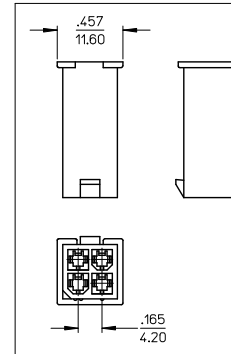
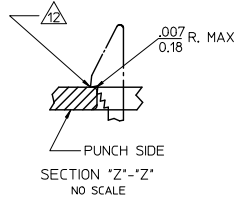
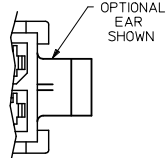
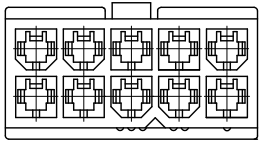

WITHOUT MOUNTING EARS
4 CIRCUIT
5559-04P1-225
SCALE: 2X

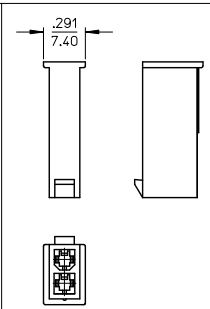

WITHOUT MOUNTING EARS
2 CIRCUIT
5559-02P1-225
SCALE: 2X

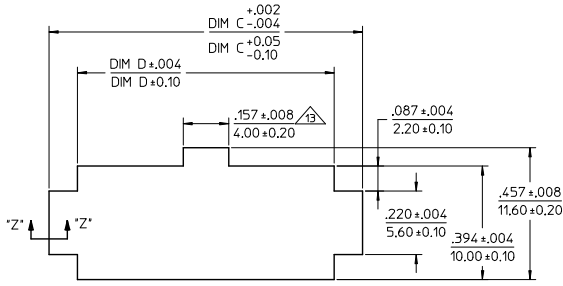

RECOMMENDED PANEL CUTOUT
THICKNESS: .032-.079 (0.80-2.00)

ADD NOT TOOLED TO -24P EC NO: UCP2015-1570 DRW: BREE 2017/10/05 CHKD: BELL 2017/10/05 APPR: SMITH 2017/10/25	QUALITY SYMBOLS	GENERAL TOLERANCES (UNLESS SPECIFIED)	DIMENSION STYLE	SCALE	DESIGN UNITS	THIRD ANGLE PROJECTION
	∇=0 ∇=0 ∇=0	mm INCH 4 PLACES ± --- ± --- 3 PLACES ± --- ± .010 2 PLACES ± 0.25 ± .015 1 PLACE ± 0.38 ± --- ANGULAR ± 1/2°	IN/MM	4:1	METRIC	MINI-FIT JR PLUG 2-24 CIRCUIT DUAL ROW W/ & W/O EARS GLOW WIRE
	DRAWN BY: LSCHMIDT CHECKED BY: ADERR APPROVED BY: SMITH	DATE: 2007/04/25 DATE: 2007/04/27 DATE: 2010/11/09	MATERIAL NO. SEE SHEET 2	DOCUMENT NO. SD-5559-425	MOLEX INCORPORATED	SHEET NO. 1 OF 2
	DRAFT WHERE APPLICABLE MUST REMAIN WITHIN DIMENSIONS	THIS DRAWING CONTAINS INFORMATION THAT IS PROPRIETARY TO MOLEX INCORPORATED AND SHOULD NOT BE USED WITHOUT WRITTEN PERMISSION				

12 11 10 9 8 7 6 5 4 3 2 1

PART NUMBER	ENGINEERING NO.	CKT SIZE	MOUNTING OPTION	DIM "A"	DIM "B"	DIM "C"	DIM "D"	PACKAGING SPECIFICATION
50-36-1678	5559-02P1-225	02	WITHOUT EARS	SEE SHEET 1	--	NOT APPLICABLE	NOT APPLICABLE	PK-5559-002
50-36-1679	5559-04P1-225	04	WITHOUT EARS	SEE SHEET 1	.165 / 4.20	NOT APPLICABLE	NOT APPLICABLE	
50-36-1675	5559-06P1-225	06	WITHOUT EARS	.54 / 13.8	.331 / 8.40	NOT APPLICABLE	NOT APPLICABLE	
50-36-1737	5559-08P1-225	08	WITHOUT EARS	.71 / 18.0	.496 / 12.60	NOT APPLICABLE	NOT APPLICABLE	
50-36-1738	5559-10P1-225	10	WITHOUT EARS	.87 / 22.2	.661 / 16.80	NOT APPLICABLE	NOT APPLICABLE	
26-01-3096	5559-12P1-225	12	WITHOUT EARS	1.04 / 26.4	.827 / 21.00	NOT APPLICABLE	NOT APPLICABLE	
NOT TOOLED	5559-14P1-225	14	WITHOUT EARS	1.21 / 30.6	.992 / 25.20	NOT APPLICABLE	NOT APPLICABLE	
50-36-1676	5559-16P1-225	16	WITHOUT EARS	1.37 / 34.8	1.158 / 29.40	NOT APPLICABLE	NOT APPLICABLE	
50-36-1677	5559-18P1-225	18	WITHOUT EARS	1.54 / 39.0	1.323 / 33.60	NOT APPLICABLE	NOT APPLICABLE	
NOT TOOLED	5559-20P1-225	20	WITHOUT EARS	1.70 / 43.2	1.488 / 37.80	NOT APPLICABLE	NOT APPLICABLE	
NOT TOOLED	5559-22P1-225	22	WITHOUT EARS	1.87 / 47.4	1.654 / 42.00	NOT APPLICABLE	NOT APPLICABLE	
NOT TOOLED	5559-24P1-225	24	WITHOUT EARS	2.03 / 51.6	1.819 / 46.20	NOT APPLICABLE	NOT APPLICABLE	PK-5559-002
50-36-1734	5559-02P-225	02	WITH EARS	.21 / 5.4	--	.425 / 10.80	.228 / 5.80	PK-5559-001
50-36-1735	5559-04P-225	04	WITH EARS	.38 / 9.6	.165 / 4.20	.591 / 15.00	.394 / 10.00	
50-36-1736	5559-06P-225	06	WITH EARS	.54 / 13.8	.331 / 8.40	.756 / 19.20	.559 / 14.20	
50-36-1716	5559-08P-225	08	WITH EARS	.71 / 18.0	.496 / 12.60	.921 / 23.40	.724 / 18.40	
50-36-1739	5559-10P-225	10	WITH EARS	.87 / 22.2	.661 / 16.80	1.087 / 27.60	.890 / 22.60	
50-36-1869	5559-12P-225	12	WITH EARS	1.04 / 26.4	.827 / 21.00	1.252 / 31.80	1.055 / 26.80	
50-36-1876	5559-14P-225	14	WITH EARS	1.21 / 30.6	.992 / 25.20	1.417 / 36.00	1.224 / 31.10	
50-36-2273	5559-16P-225	16	WITH EARS	1.37 / 34.8	1.158 / 29.40	1.583 / 40.20	1.390 / 35.30	
26-01-3187	5559-18P-225	18	WITH EARS	1.54 / 39.0	1.323 / 33.60	1.748 / 44.40	1.555 / 39.50	
NOT TOOLED	5559-20P-225	20	WITH EARS	1.70 / 43.2	1.488 / 37.80	1.913 / 48.60	1.720 / 43.70	
NOT TOOLED	5559-22P-225	22	WITH EARS	1.87 / 47.4	1.654 / 42.00	2.079 / 52.80	1.886 / 47.90	
46999-0166	5559-24P-225	24	WITH EARS	2.03 / 51.6	1.819 / 46.20	2.244 / 57.00	2.051 / 52.10	PK-5559-001

X = NOT TOOLED

LEGEND

5559-***P*-225

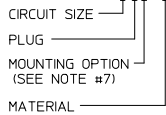

NOTES:

- MATERIAL: "225" = NYLON (PA6), UL94V-0, COLOR: BLACK; IEC 60335-1, 4th EDITION GLOW WIRE CAPABLE.
- FINISH: NOT APPLICABLE
- PRODUCT SPECIFICATION: PS-5556-001
- PACKAGING: SEE CHART
- PART MATES WITH MOLEX RECEPTACLE #5557.
- PART TO BE USED WITH MOLEX MALE TERMINAL #5558.
- MOUNTING OPTIONS: "BLANK" = WITH EARS "1" = WITHOUT EARS
- PART IS NOT DESIGNED FOR CURRENT SHARING.
- CONNECTORS ARE NOT TO BE MATED OR UNMATED WHILE CIRCUITS ARE LIVE.
- WIRES ARE TO BE DRESSED IN SUCH A MANNER TO ALLOW THE TERMINALS TO FLOAT FREELY IN THE POCKET.
- PART CONFORMS TO CLASS "B" REQUIREMENTS OF COSMETIC SPECIFICATION PS-45499-002 WITH THE EXCEPTION OF DISCOLORATION, FLASH AND SINK MEET CLASS "C" REQUIREMENTS.
- PANEL HOLE TO PUNCHED OUT IN THE SAME DIRECTION AS INSERTION INTO THE PANEL.
- ON 2 CIRCUIT PARTS THIS DIMENSION IS ALLOWABLE UP TO DIMENSION "D".
- TO BE MEASURED AT SURFACE [A]

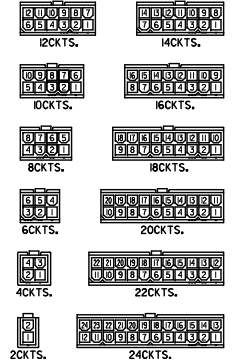

REFERENCE FOR CIRCUIT NUMBER ORIENTATION (OPTIONAL EARS NOT SHOWN)

SEE SHEET 1 IEC NO: UCP2013-1370 DRAWN BY: DRWINBEE 2017/10/05 CHKD: BELL 2017/10/05 APPROV: SMITH 2017/10/25 DESCRIPTION:	QUALITY SYMBOLS ∇=0 ∇=0 ∇=0	GENERAL TOLERANCES (UNLESS SPECIFIED) mm INCH	DIMENSION STYLE IN/MM	SCALE 1:1	DESIGN UNITS METRIC	THIRD ANGLE PROJECTION
		4 PLACES ± --- ± --- 3 PLACES ± --- ± .010 2 PLACES ± 0.25 ± .015 1 PLACE ± 0.38 ± --- ANGULAR ± 1/2°	DRAWN BY: LSCHMIDT CHECKED BY: ADERR APPROVED BY: F SMITH DATE: 2007/04/25 DATE: 2007/04/27 DATE: 2010/11/09	TITLE MINI-FIT JR PLUG 2-24 CIRCUIT DUAL ROW W/ & W/O EARS GLOW WIRE	MOLEX INCORPORATED	MATERIAL NO. SEE CHART