

## Excellent Integrated System Limited

Stocking Distributor

Click to view price, real time Inventory, Delivery & Lifecycle Information:

[Molex Connector Corporation](#)  
[0461146241](#)

For any questions, you can email us directly:

[sales@integrated-circuit.com](mailto:sales@integrated-circuit.com)

NO OF SIGNALS	MATERIAL NUMBER	COMPLIANT P/N PLATING	DM A	DM B	DM C
12	46114-6120	TN	53.01/2.087	53.51/2.107	
16	46114-6160	TN	55.55/2.187	56.05/2.207	
20	46114-6200	TN	58.09/2.287	58.59/2.307	
24	46114-6240	TN	60.63/2.287	61.13/2.407	5.45/215
28	46114-6280	TN	63.17/2.387	63.67/2.507	
32	46114-6320	TN	65.71/2.487	66.21/2.607	
36	46114-6360	TN	68.25/2.587	68.75/2.707	
40	46114-6400	TN	70.79/2.787	71.29/2.807	

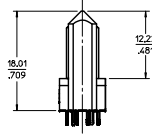
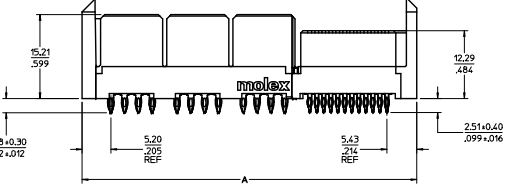
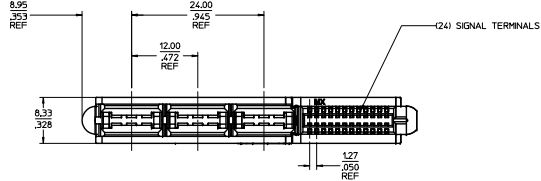

- NOTES:
1. MATERIAL: HOUSING: LCP, 94-V0, COLOR: BLACK, POWER CONTACTS: COPPER ALLOY, SIGNAL CONTACTS: COPPER ALLOY.
  2. FINISH: SELECT GOLD - 0.75 μM/30 μ INCHES, SELECTED TIN - 250 μM/1000 μ INCHES, BOTH OVER NICKEL - 125 μM/50 μ INCHES.
  3. POWER TERMINALS ARE LUBRICATED IN CONTACT AREA.
  4. PARTS ARE ROHS COMPLIANT.
  5. MATES TO MOLEX P/N 45985-SERIES ON EDGE CARD 157/062.
  6. PRODUCT SPECIFICATION PS-46114-001.
  7. PACKAGING PER PK-46114-003.

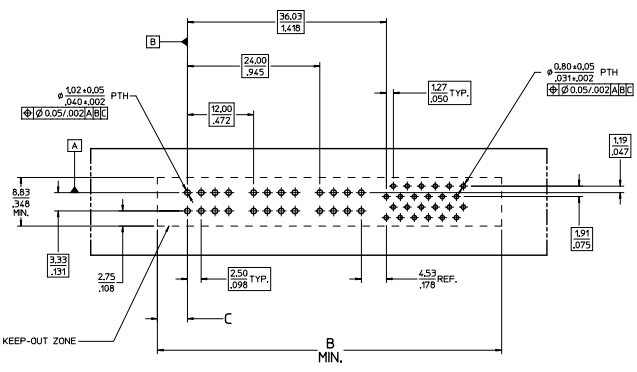
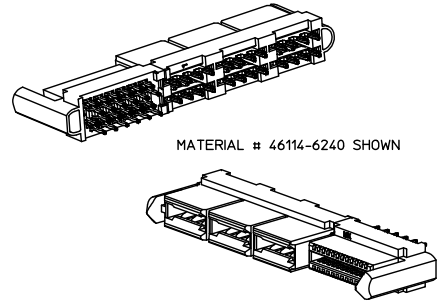

PCB COMPONENT SIDE  
par 2-of-top2  
SCALE 3:1

QUALITY SYMBOLS	GENERAL TOLERANCES (UNLESS SPECIFIED)		DIMENSION STYLE		SCALE	DESIGN UNITS	THIRD ANGLE PROJECTION
	mm	INCH	MM/IN	MM/IN			
▽=0	4 PLACES ±	---	---	---	3:1	METRIC	THIRD ANGLE PROJECTION
▽=0	3 PLACES ±	±0.10	---	---			
▽=0	2 PLACES ±	±0.25	---	---			
▽=0	1 PLACE ±	---	---	---			
▽=0	0 PLACE ±	---	---	---			

ADD DIMENSION	QUALITY SYMBOLS	GENERAL TOLERANCES (UNLESS SPECIFIED)	DIMENSION STYLE	SCALE	DESIGN UNITS	THIRD ANGLE PROJECTION
EC NO. 10/2005-0571	▽=0	4 PLACES ±	MM/IN	3:1	METRIC	THIRD ANGLE PROJECTION
DRW:RABANDRA	▽=0	3 PLACES ±				
CHKD: JCOMERC	▽=0	2 PLACES ±				
APPROVAL: JCOMERC	▽=0	1 PLACE ±				
DATE: 2005/04/20	▽=0	0 PLACE ±				

DRAWN BY: MKARADI MAS	DATE: 2005/11/28	TITLE: LPH VERTICAL RECEPTACLE ASSEMBLY 6 CIRCUIT PWR CONNECTOR, PRESS FIT
CHECKED BY: APATEL	DATE: 10/13/06	
APPROVED BY: JCOMERC	DATE: 2009/12/03	
MATERIAL NO. SEE CHART	DOCUMENT NO. SD-46114-600	SHEET NO. 1 OF 3
ANGULAR ±1/2°		
DRAFT WHERE APPLICABLE MUST REMAIN WITHIN DIMENSIONS		
SIZE D	THIS DRAWING CONTAINS INFORMATION THAT IS PROPRIETARY TO MOLEX INCORPORATED AND SHOULD NOT BE USED WITHOUT WRITTEN PERMISSION	



MATERIAL # 46114-6241

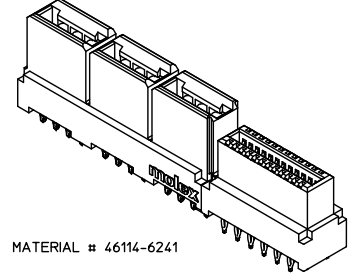
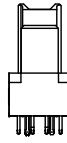
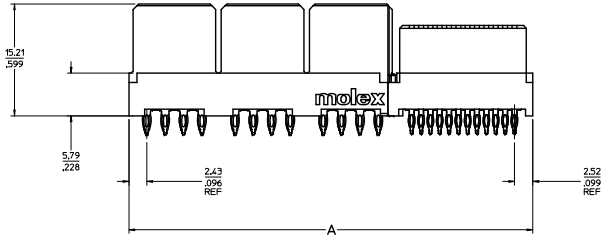
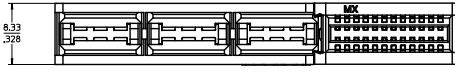

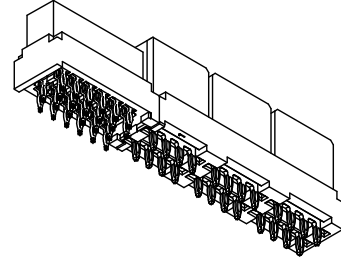
NO OF SIGNALS	MATERIAL NUMBER	COMPLIANT PIN PLATING	DM A	DM B	DM C
12	46114-6121	TIN	47.34/1.864	47.84/1.883	
16	46114-6161	TIN	49.88/1.964	50.38/1.983	
20	46114-6201	TIN	52.42/2.064	52.92/2.083	
24	46114-6241	TIN	54.96/2.164	55.46/2.183	2.69/106
28	46114-6281	TIN	57.50/2.264	58.00/2.283	
32	46114-6321	TIN	60.04/2.364	60.54/2.383	
36	46114-6361	TIN	62.58/2.464	63.08/2.483	
40	46114-6401	TIN	65.12/2.564	65.62/2.583	

QUALITY SYMBOLS	GENERAL TOLERANCES (UNLESS SPECIFIED)		DIMENSION STYLE		SCALE	DESIGN UNITS	THIRD ANGLE PROJECTION
	mm	INCH	MM/IN	MM/IN			
∇=0	4 PLACES ±---	±---	DRAWN BY	DATE	4:1	METRIC	
∇=0	3 PLACES ±---	±.010	MKARADIMAS	2005/11/28			
∇=0	2 PLACES ±0.25	±---	CHECKED BY	DATE	<b>LPH VERTICAL RECEPTACLE ASSEMBLY 6 CIRCUIT PWR CONNECTOR, PRESS FIT</b> 		
∇=0	1 PLACE ±---	±---	APATEL	10/13/06			
∇=0	0 PLACE ±	±	APPROVED BY	DATE	MATERIAL NO: <b>SD-46114-600</b> SHEET NO: <b>2 OF 3</b> SEE CHART THIS DRAWING CONTAINS INFORMATION THAT IS PROPRIETARY TO MOLEX INCORPORATED AND SHOULD NOT BE USED WITHOUT WRITTEN PERMISSION		
			JCOMERC	2009/12/03			

NO OF SIGNAL	DIM. D
12	8.00/.315
16	10.54/.415
20	13.08/.515
24	15.62/.615
28	18.16/.715
32	20.70/.815
36	23.24/.915
40	25.78/1.015

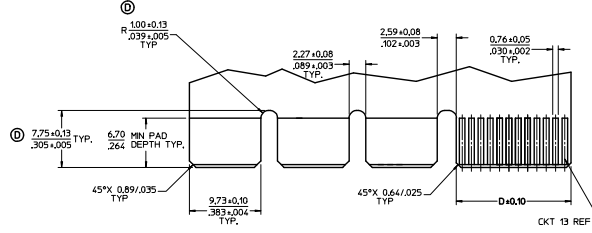
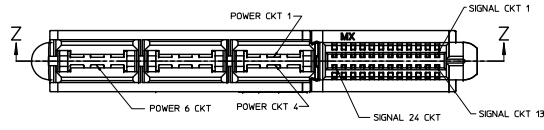
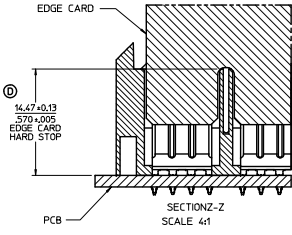

RECOMMENDED EDGE CARD LAYOUT  
EDGE CARD THICKNESS: 157/.062 ± 0.15/.006  
PLATING: GOLD 30 μ INCHES MIN.  
OVER 150 μ INCHES NICKEL.

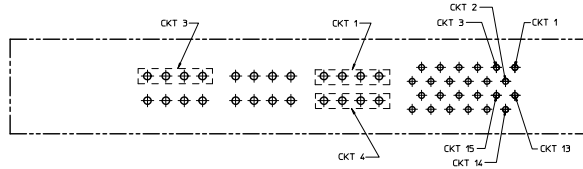

PCB LAYOUT: COMPONENT SIDE  
SEE SH1 FOR DIMENSIONS

SEE SHEET 1 SEC. NO. 0461146241-0571 DRAWN BY: DR. N. BANDRA 20/08/19 CHKD: AP. PATEL 20/08/19 APPR: AP. PATEL 20/08/19 REV:	QUALITY SYMBOLS	GENERAL TOLERANCES (UNLESS SPECIFIED)	DIMENSION STYLE	SCALE	DESIGN UNITS	THIRD ANGLE PROJECTION	
	∇=0 4 PLACES ± --- ± --- ∇=0 3 PLACES ± --- ± .010 ∇=0 2 PLACES ± 0.25 ± --- ∇=0 1 PLACE ± --- ± --- ∇=0 0 PLACE ± --- ± ---	mm INCH ± --- ± --- ± .010 ± --- ± --- ± --- ± --- ± --- ± ---	DRAWN BY: MKARADIMAS DATE: 2005/11/28 CHECKED BY: APATEL DATE: 10/13/06 APPROVED BY: JCOMERC I DATE: 2009/12/03	MM/IN	4:1	METRIC	TITLE: LPH VERTICAL RECEPTACLE ASSEMBLY 6 CIRCUIT PWR CONNECTOR PRESS FIT MATERIAL NO. SEE CHART DOCUMENT NO. SD-46114-600 SHEET NO. 3 OF 3
	ANGULAR: ±1/2° DRAFT WHERE APPLICABLE MUST REMAIN WITHIN DIMENSIONS SEE CHART THIS DRAWING CONTAINS INFORMATION THAT IS PROPRIETARY TO MOLEX INCORPORATED AND SHOULD NOT BE USED WITHOUT WRITTEN PERMISSION						