

## Excellent Integrated System Limited

Stocking Distributor

Click to view price, real time Inventory, Delivery & Lifecycle Information:

[Molex Connector Corporation](#)  
[0520250411](#)

For any questions, you can email us directly:

[sales@integrated-circuit.com](mailto:sales@integrated-circuit.com)

10 9 8 7 6 5 4 3 2 1

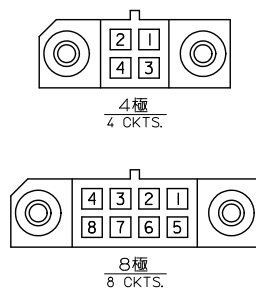
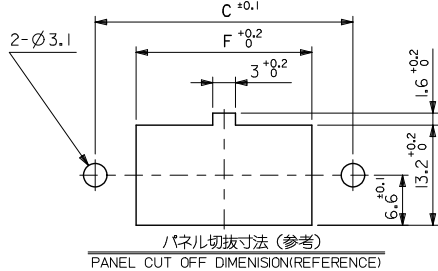
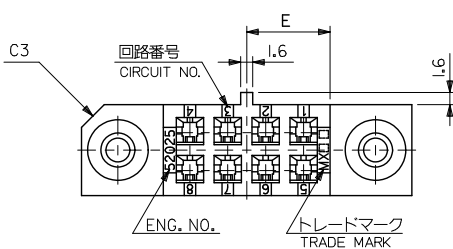

回路レイアウト図

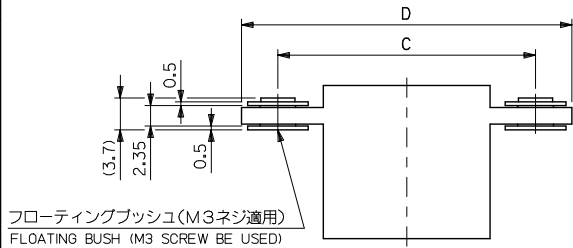

フローティングブッシュ(M3ネジ適用)  
FLOATING BUSH (M3 SCREW BE USED)

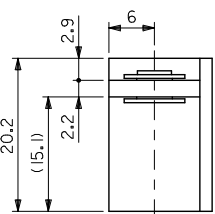

注記  
NOTES

- 適用ターミナル : 5558 シリーズ  
APPLICABLE TERMINAL : 5558 SERIES
- 嵌合相手 : 51010-\*\*\*  
MATES WITH : 51010-\*\*\*
- パネル外-外寸法 : 18.6 (下図参照)  
BETWEEN PANEL-PANEL DIMENSION : 18.6 (SEE BELOW FIGURE)

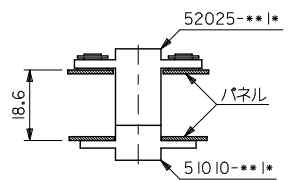
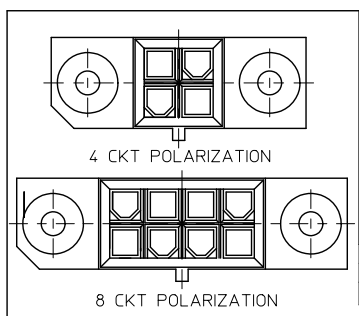
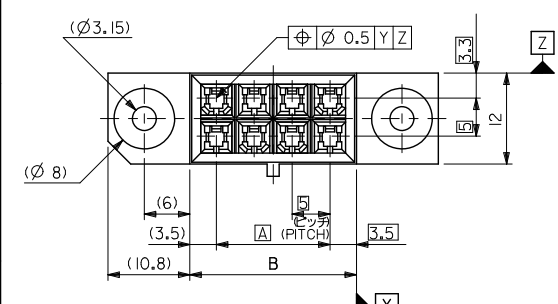

23.2	11	43.6	34	22	15	52025-0811	BLACK	8
13.2	6	33.6	24	12	5	52025-0411		4
F	E	D	C	B	A	MATERIAL NO.	COLOR	極数 CKTS

材料  
MATERIAL  
本体 : G.F.15% PBTP, UL94V-0  
HOUSING : G.F.15% PBTP, UL94V-0  
ブッシュ : 黄銅, ニッケルメッキ  
BUSH : BRASS, NICKEL PLATING

ADD 4 & 8 CKT VIEW EC NO: UCP2012-1179 DRAWING: 2011/10/13 CHKD: BELL APPR: F. SMITH REV: D1	GENERAL TOLERANCES (UNLESS SPECIFIED)		DIMENSION STYLE MM ONLY		SCALE 2:1	DESIGN UNITS METRIC	THIRD ANGLE PROJECTION	
	10 UNDER	± 0.2	DRAWN BY T. HIRAMOTO	DATE '89/11/24	TITLE MINI. DRAWER CONN. CRIMP PIN HOUSING ASSY			
	10 OVER 30 UNDER	± 0.25	CHECKED BY M. FUKUSHIMA	DATE '90/4/5	MODEL NO. 52025-***1*			
	30 OVER	± 0.3	APPROVED BY M. ENOMOTO	DATE '90/4/5	MOLEX INCORPORATED			
ANGULAR ± 3 °		DRAFT WHERE APPLICABLE MUST REMAIN WITHIN DIMENSIONS		MATERIAL NO.	DOCUMENT NO. SD-52025-001	SHEET NO. 1 OF 1		
SEE TABLE				THIS DRAWING CONTAINS INFORMATION THAT IS PROPRIETARY TO MOLEX INCORPORATED AND SHOULD NOT BE USED WITHOUT WRITTEN PERMISSION				