

Excellent Integrated System Limited

Stocking Distributor

Click to view price, real time Inventory, Delivery & Lifecycle Information:

[Molex Connector Corporation](#)
[0399700305](#)

For any questions, you can email us directly:

sales@integrated-circuit.com

10 9 8 7 6 5 4 3 2 39970

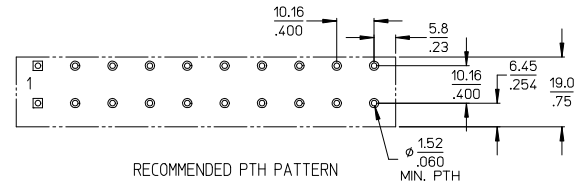
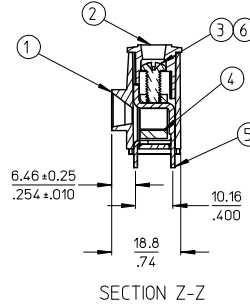
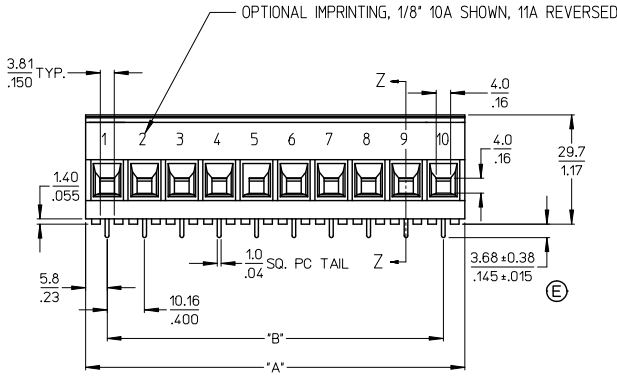
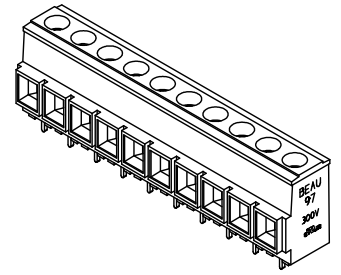
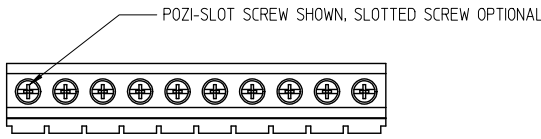

NOTES:

1. MATERIAL: SEE TABLE.
2. FINISHES: SEE TABLE.
3. PRODUCT SPECIFICATION: NOT REQUIRED.
4. ALL FEATURES ARE TYPICAL UNLESS OTHERWISE NOTED.
5. PART IS DESIGNED TO MEET UL 1059 CLASS C 300V, 40A.
6. 'XX' REFERS TO NUMBER OF CIRCUITS.
7. ASSEMBLY IS ROHS COMPLIANT.



ITEM	QTY.	DESCRIPTION	MATERIAL	FINISH
6	XX	SCREW, M4 X 0.7 SLOTTED	BRONZE	TIN PLATE
5	XX	TERMINAL	COPPER	TIN PLATE
4	XX	CAGE	BRASS	NICKEL PLATE
3	XX	SCREW, M4 X 0.7 POZI-SLOT	BRONZE	TIN PLATE
2	1	COVER	POLYESTER (PBT)	BLACK
1	1	BODY	POLYESTER (PBT)	BLACK

UPDATE TERM: HEIGHT DIM EC NO: WNA/2009-04/5 2009/07/01 DRAWN: ENCLMS 2009/07/02 CHKD: UORR 2009/07/02 APPR: JMACNEIL 2009/07/02	QUALITY SYMBOLS ▽=0 ▽=0	GENERAL TOLERANCES (UNLESS SPECIFIED)		DIMENSION STYLE MM/IN		SCALE 1:1	DESIGN UNITS INCH	THIRD ANGLE PROJECTION
		4 PLACES ± --- ± --- 3 PLACES ± --- ± .005 2 PLACES ± 0.13 ± .01 1 PLACE ± 0.3 ± --- ANGULAR ± 2°	DRAWN BY R. STONE 2002/09/13	DATE 2002/09/13	TITLE 10.16MM/.400 SINGLE ROW BTS ASSY, 8 AWG, 300V 40A			
		DRAFT WHERE APPLICABLE MUST REMAIN WITHIN DIMENSIONS	CHECKED BY R. KEMP 2002/09/13	DATE 2002/09/13	MOLEX INCORPORATED			
		SEE CHART	APPROVED BY L. RÖTHAUS 2002/09/27	DATE 2002/09/27	MATERIAL NO. SD-39970-004	DOCUMENT NO.	SHEET NO. 1 OF 2	

9 8 7 6 5 4 3 2 1

10 9 8 7 6 5 4 3 2 39970

STD MATERIAL NUMBER	OPTIONAL 10A IMPRINT	OPTIONAL 11A IMPRINT	OPTIONAL SLOTTED SCREW	OPTIONAL SLOTTED SCREW W/10A IMPRINT	OPTIONAL SLOTTED SCREW W/11A IMPRINT	NUMBER OF CIRCUITS	"A" DIM.	"B" DIM.
399700302	399720302	399730302	399700502	399720502	399730502	2	21.84 [.86]	10.16 [.400]
399700303	399720303	399730303	399700503	399720503	399730503	3	32.00 [1.26]	20.32 [.800]
399700304	399720304	399730304	399700504	399720504	399730504	4	42.16 [1.66]	30.48 [1.200]
399700305	399720305	399730305	399700505	399720505	399730505	5	52.32 [2.06]	40.64 [1.600]
399700306	399720306	399730306	399700506	399720506	399730506	6	62.48 [2.46]	50.80 [2.000]
399700307	399720307	399730307	399700507	399720507	399730507	7	72.64 [2.86]	60.96 [2.400]
399700308	399720308	399730308	399700508	399720508	399730508	8	82.80 [3.26]	71.12 [2.800]
399700309	399720309	399730309	399700509	399720509	399730509	9	92.96 [3.66]	81.28 [3.200]
399700310	399720310	399730310	399700510	399720510	399730510	10	103.12 [4.06]	91.44 [3.600]
399700311	399720311	399730311	399700511	399720511	399730511	11	113.28 [4.46]	101.60 [4.000]
399700312	399720312	399730312	399700512	399720512	399730512	12	123.44 [4.86]	111.76 [4.400]
399700313	399720313	399730313	399700513	399720513	399730513	13	133.60 [5.26]	121.92 [4.800]
399700314	399720314	399730314	399700514	399720514	399730514	14	143.76 [5.66]	132.08 [5.200]

SEE SHEET ONE EC NO: WNA2009-0445 DRAWN: ENCLMS 2009/07/01 CHECK: URBK 2009/07/02 APPR: JMA/NEIL 2009/07/02 REV	QUALITY SYMBOLS	GENERAL TOLERANCES (UNLESS SPECIFIED)		DIMENSION STYLE		SCALE	DESIGN UNITS	THIRD ANGLE PROJECTION
		mm	INCH	MM/IN		1:1	INCH	
		4 PLACES ± .005	± .005	DRAWN BY	DATE	TITLE 10.16MM/.400 SINGLE ROW BTS ASSY, 8 AWG, 300V 40A MOLEX INCORPORATED DOCUMENT NO. SD-39970-004 SHEET NO. 2 OF 2		
		3 PLACES ± .005	± .005	GHR	2000/02/09			
2 PLACES ± 0.13	± .01	CHECKED BY	DATE					
1 PLACE ± 0.3	± .01	APPROVED BY	DATE	MATERIAL NO. SEE CHART				
	ANGULAR ± 2°	DRAFT WHERE APPLICABLE MUST REMAIN WITHIN DIMENSIONS		APPROVED BY L. RÖTHAUS 2000/02/09				

9 8 7 6 5 4 3 2 1