

Excellent Integrated System Limited

Stocking Distributor

Click to view price, real time Inventory, Delivery & Lifecycle Information:

[Diodes Incorporated](#)
[DMP4047LFDE-7](#)

For any questions, you can email us directly:

sales@integrated-circuit.com



DMP4047LFDE

40V P-CHANNEL ENHANCEMENT MODE MOSFET

Product Summary

$V_{(BR)DSS}$	$R_{DS(ON)max}$	Package	$I_D max$ $T_A = +25^{\circ}C$
-40V	33mΩ @ $V_{GS} = -10V$	U-DFN2020-6 Type E	-6A
	50mΩ @ $V_{GS} = -4.5V$		-4.9A

Description

This new generation MOSFET has been designed to minimize the on-state resistance ($R_{DS(on)}$) and yet maintain superior switching performance, making it ideal for high efficiency power management applications.

Applications

- General Purpose Interfacing Switch
- Load Switching
- Battery Management Application
- Power Management Functions

Features

- 0.6mm profile – ideal for low profile applications
- PCB footprint of 4mm²
- Low Gate Threshold Voltage
- Low On-Resistance
- **Totally Lead-Free & Fully RoHS Compliant (Notes 1 & 2)**
- **Halogen and Antimony Free. "Green" Device (Note 3)**
- **Qualified to AEC-Q101 Standards for High Reliability**

Mechanical Data

- Case: U-DFN2020-6 Type E
- Case Material: Molded Plastic, "Green" Molding Compound. UL Flammability Classification Rating 94V-0
- Moisture Sensitivity: Level 1 per J-STD-020
- Terminals: Finish – NiPdAu over Copper leadframe. Solderable per MIL-STD-202, Method 208 (e4)
- Weight: 0.0065 grams (approximate)

U-DFN2020-6 Type E

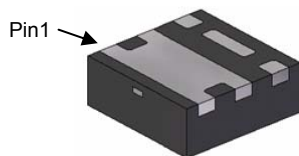

Bottom View

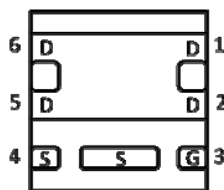

Pin Out
Bottom View

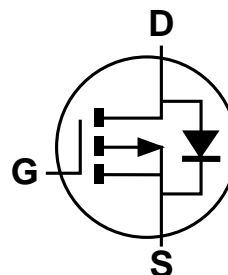

Equivalent Circuit

Ordering Information (Note 4)

Part Number	Marking	Reel size (inches)	Quantity per reel
DMP4047LFDE-7	PE	7	3,000
DMP4047LFDE-13	PE	13	10,000

- Notes:
1. No purposely added lead. Fully EU Directive 2002/95/EC (RoHS) & 2011/65/EU (RoHS 2) compliant.
 2. See <http://www.diodes.com> for more information about Diodes Incorporated's definitions of Halogen- and Antimony-free, "Green" and Lead-free.
 3. Halogen- and Antimony-free "Green" products are defined as those which contain <900ppm bromine, <900ppm chlorine (<1500ppm total Br + Cl) and <1000ppm antimony compounds.
 4. For packaging details, go to our website at <http://www.diodes.com>.

Marking Information

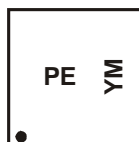

PE = Product Type Marking Code
 YM = Date Code Marking
 Y = Year (ex: Y = 2011)
 M = Month (ex: 9 = September)

Date Code Key

Year	2011	2012	2013	2014	2015	2016	2017
Code	Y	Z	A	B	C	D	E

Month	Jan	Feb	Mar	Apr	May	Jun	Jul	Aug	Sep	Oct	Nov	Dec
Code	1	2	3	4	5	6	7	8	9	O	N	D

Maximum Ratings (@ $T_A = +25^\circ\text{C}$, unless otherwise specified.)

Characteristic			Symbol	Value	Units
Drain-Source Voltage			V_{DSS}	-40	V
Gate-Source Voltage			V_{GSS}	± 20	V
Continuous Drain Current (Note 5) $V_{GS} = 10\text{V}$	Steady State	$T_A = +25^\circ\text{C}$ $T_A = +70^\circ\text{C}$	I_D	-3.3 -2.6	A
	$t < 5\text{s}$	$T_A = +25^\circ\text{C}$ $T_A = +70^\circ\text{C}$	I_D	-5.3 -4.2	A
Continuous Drain Current (Note 6) $V_{GS} = 10\text{V}$	Steady State	$T_A = +25^\circ\text{C}$ $T_A = +70^\circ\text{C}$	I_D	-6.0 -4.8	A
	$t < 5\text{s}$	$T_A = +25^\circ\text{C}$ $T_A = +70^\circ\text{C}$	I_D	-9.5 -7.6	A
Pulsed Drain Current (10 μs pulse, duty cycle = 1%)			I_{DM}	-40	A
Maximum Body Diode Continuous Current			I_S	3	A

Thermal Characteristics

Characteristic		Symbol	Value	Units
Total Power Dissipation (Note 5)	$T_A = +25^\circ\text{C}$	P_D	0.7	W
	$T_A = +70^\circ\text{C}$		0.42	
Thermal Resistance, Junction to Ambient (Note 5)	Steady state	$R_{\theta JA}$	180	$^\circ\text{C/W}$
	$t < 5\text{s}$		76	
Total Power Dissipation (Note 6)	$T_A = +25^\circ\text{C}$	P_D	2.1	W
	$T_A = +70^\circ\text{C}$		1.3	
Thermal Resistance, Junction to Ambient (Note 6)	Steady state	$R_{\theta JA}$	58	$^\circ\text{C/W}$
	$t < 5\text{s}$		25	
Thermal Resistance, Junction to Case (Note 6)		$R_{\theta JC}$	10.2	
Operating and Storage Temperature Range		T_J, T_{STG}	-55 to +150	$^\circ\text{C}$

Electrical Characteristics (@ $T_A = +25^\circ\text{C}$, unless otherwise specified.)

Characteristic	Symbol	Min	Typ	Max	Unit	Test Condition
OFF CHARACTERISTICS (Note 7)						
Drain-Source Breakdown Voltage	BV_{DSS}	-40	—	—	V	$V_{GS} = 0\text{V}, I_D = 250\mu\text{A}$
Zero Gate Voltage Drain Current $T_J = +25^\circ\text{C}$	I_{DSS}	—	—	1	μA	$V_{DS} = -40\text{V}, V_{GS} = 0\text{V}$
Gate-Source Leakage	I_{GSS}	—	—	± 100	nA	$V_{GS} = \pm 20\text{V}, V_{DS} = 0\text{V}$
ON CHARACTERISTICS (Note 7)						
Gate Threshold Voltage	$V_{GS(th)}$	-1.0	—	-2.2	V	$V_{DS} = V_{GS}, I_D = 250\mu\text{A}$
Static Drain-Source On-Resistance	$R_{DS(on)}$	—	26	33	m Ω	$V_{GS} = -10\text{V}, I_D = -4.4\text{A}$
			36	50		$V_{GS} = -4.5\text{V}, I_D = -3.7\text{A}$
Forward Transfer Admittance	$ Y_{fs} $	—	5.2	—	S	$V_{DS} = -15\text{V}, I_D = -4.4\text{A}$
Diode Forward Voltage	V_{SD}	—	0.75	1.2	V	$V_{GS} = 0\text{V}, I_S = -3.9\text{A}$
DYNAMIC CHARACTERISTICS (Note 8)						
Input Capacitance	C_{iss}	—	1382	—	pF	$V_{DS} = -20\text{V}, V_{GS} = 0\text{V},$ $f = 1.0\text{MHz}$
Output Capacitance	C_{oss}	—	103	—	pF	
Reverse Transfer Capacitance	C_{rss}	—	81	—	pF	
Gate Resistance	R_g	—	7.7	—	Ω	$V_{DS} = 0\text{V}, V_{GS} = 0\text{V}, f = 1\text{MHz}$
Total Gate Charge ($V_{GS} = -4.5\text{V}$)	Q_g	—	11.2	—	nC	$V_{DS} = -20\text{V}, I_D = -4.9\text{A}$
Total Gate Charge ($V_{GS} = -10\text{V}$)	Q_g	—	23.2	—	nC	
Gate-Source Charge	Q_{gs}	—	3.3	—	nC	
Gate-Drain Charge	Q_{gd}	—	3.9	—	nC	
Turn-On Delay Time	$t_{D(on)}$	—	18.4	—	ns	$V_{DS} = -20\text{V}, I_D = -3.9\text{A}$ $V_{GS} = 4.5\text{V}, R_G = 1\Omega$
Turn-On Rise Time	t_r	—	28.2	—	ns	
Turn-Off Delay Time	$t_{D(off)}$	—	38.8	—	ns	
Turn-Off Fall Time	t_f	—	28.6	—	ns	
Reverse Recovery Time	t_{rr}	—	15.4	—	ns	$I_F = -3.9\text{A}, di/dt = 100\text{A}/\mu\text{s}$
Reverse Recovery Charge	Q_{rr}	—	5.4	—	nC	

- Notes:
- Device mounted on FR-4 PC board, with minimum recommended pad layout, single sided.
 - Device mounted on FR-4 substrate PC board, 2oz copper, with thermal vias to bottom layer 1inch square copper plate
 - Short duration pulse test used to minimize self-heating effect
 - Guaranteed by design. Not subject to production testing



DMP4047LFDE

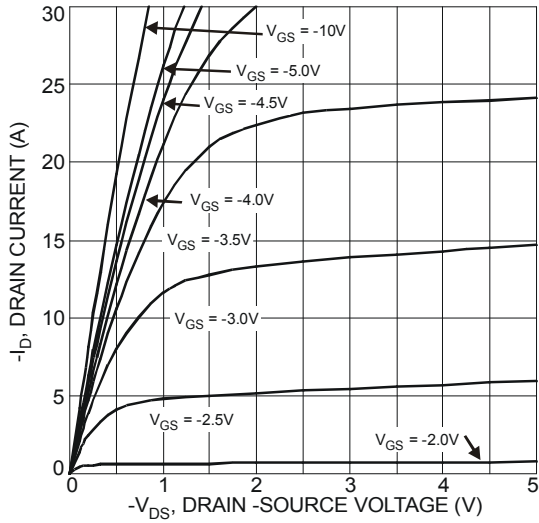

Fig. 1 Typical Output Characteristics

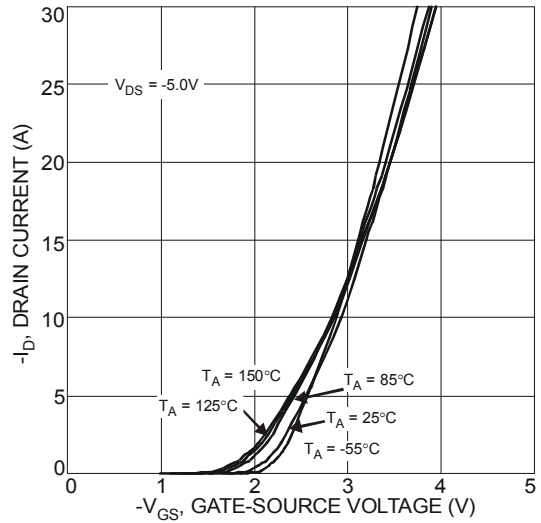

Fig. 2 Typical Transfer Characteristics

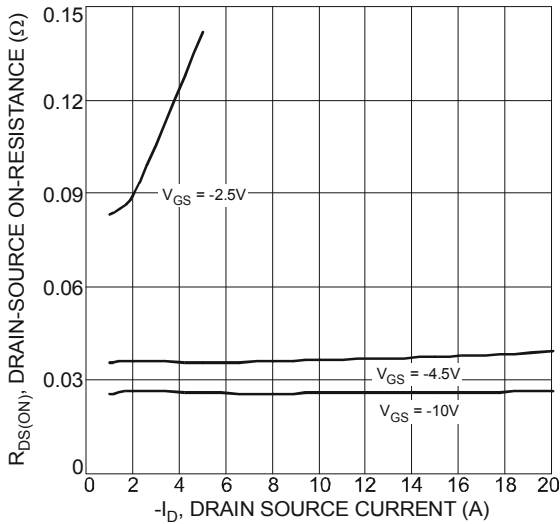

Fig. 3 Typical On-Resistance vs. Drain Current and Gate Voltage

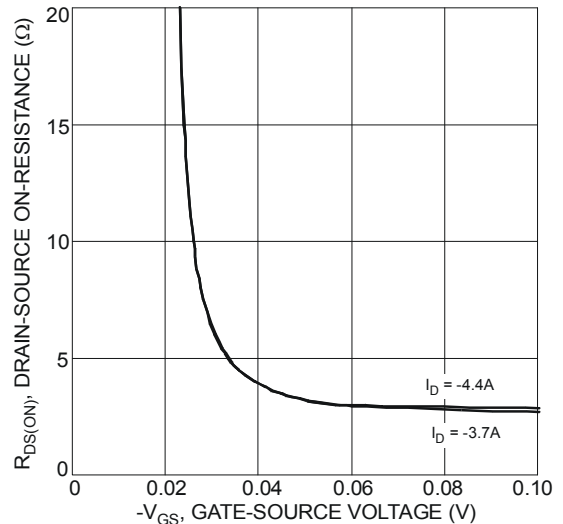

Fig. 4 Typical Drain-Source On-Resistance vs. Gate-Source Voltage

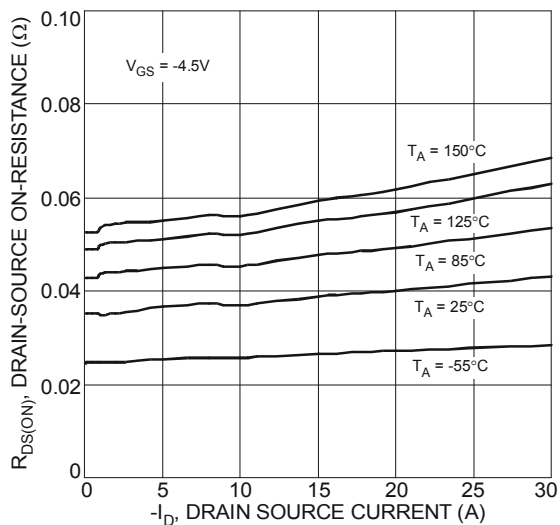

Fig. 5 Typical On-Resistance vs. Drain Current and Temperature

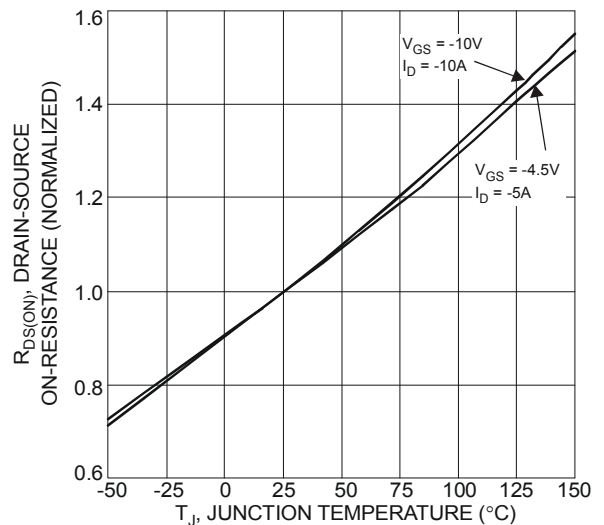

Fig. 6 On-Resistance Variation with Temperature



DMP4047LFDE

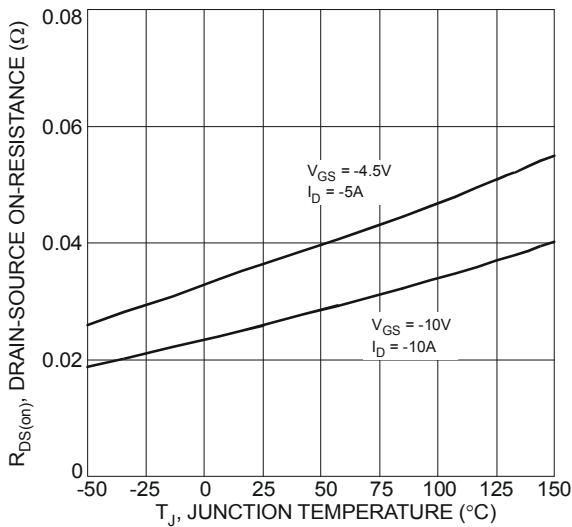

Fig. 7 On-Resistance Variation with Temperature

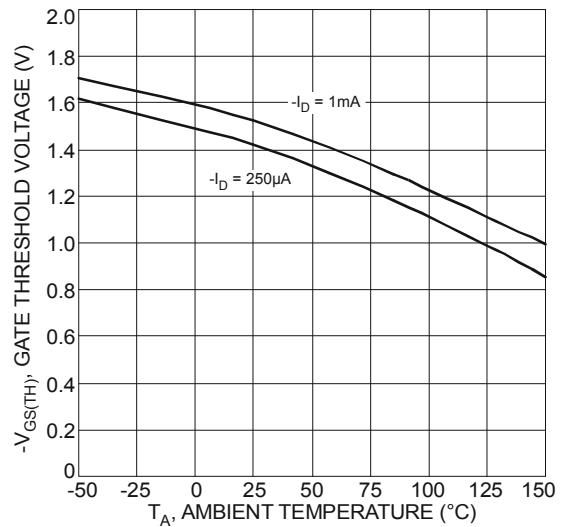

Fig. 8 Gate Threshold Variation vs. Ambient Temperature

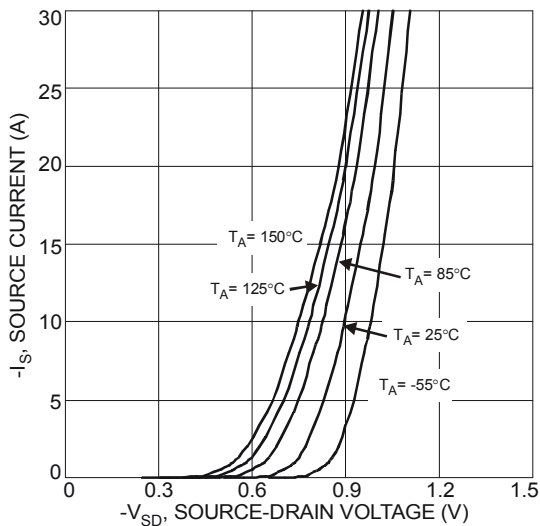

Fig. 9 Diode Forward Voltage vs. Current

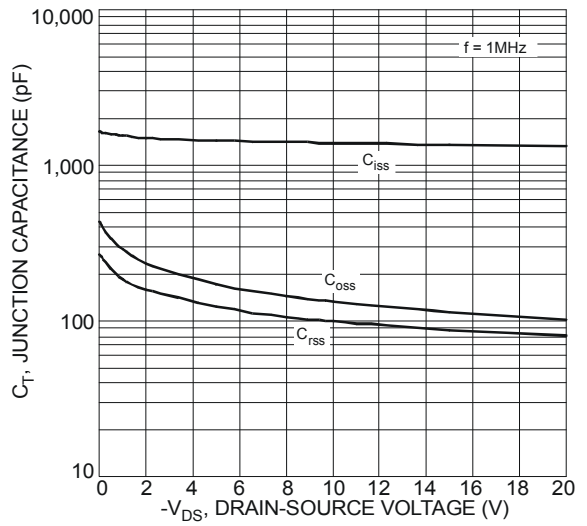

Fig. 10 Typical Junction Capacitance

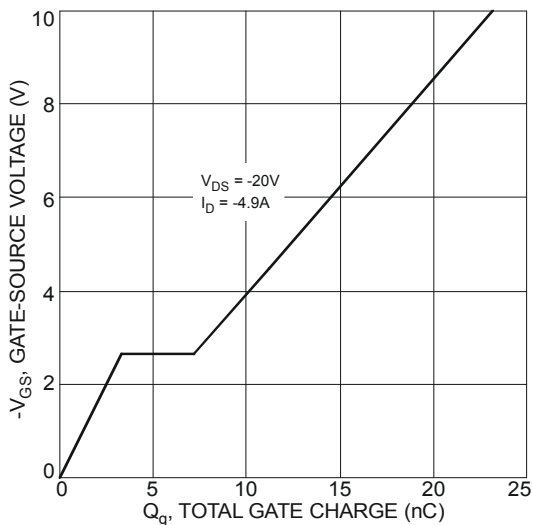

Fig. 11 Gate-Charge Characteristics

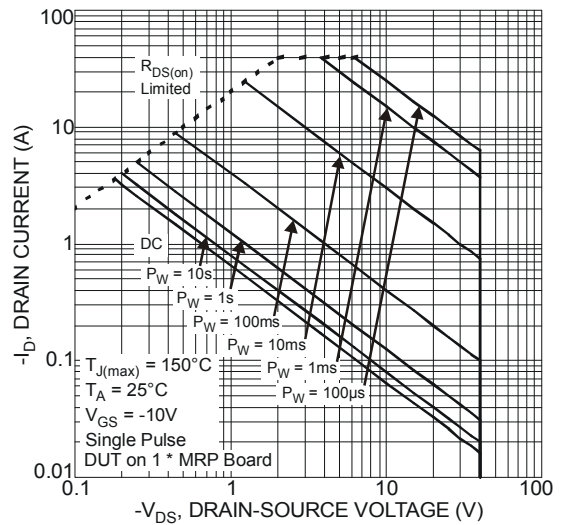
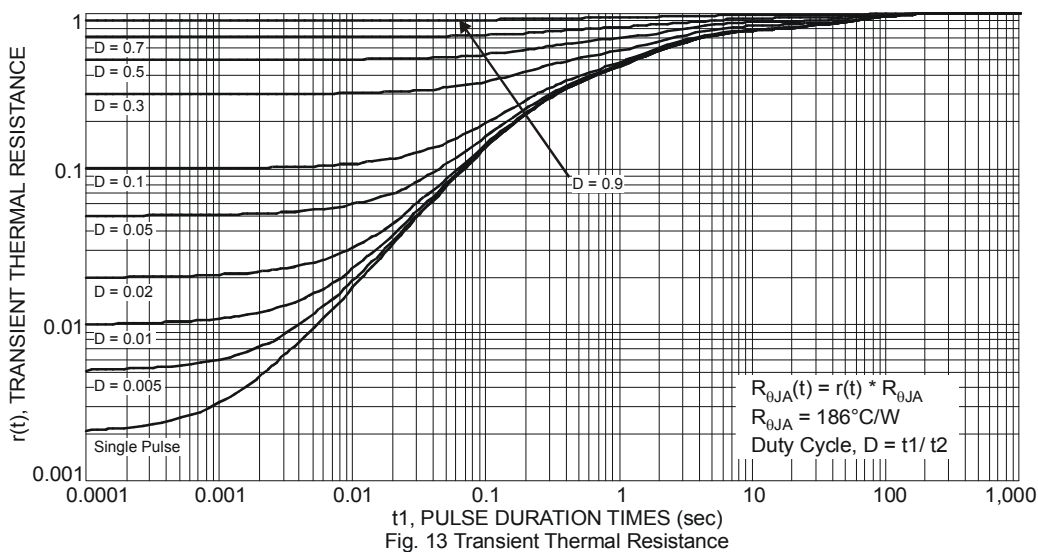

Fig. 12 SOA, Safe Operation Area



DMP4047LFDE



Package Outline Dimensions

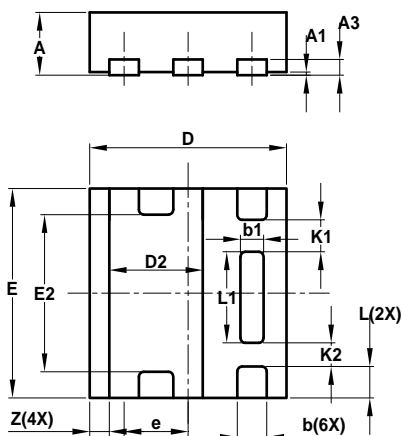

U-DFN2020-6 Type E			
Dim	Min	Max	Typ
A	0.57	0.63	0.60
A1	0	0.05	0.03
A3	—	—	0.15
b	0.25	0.35	0.30
b1	0.185	0.285	0.235
D	1.95	2.05	2.00
D2	0.85	1.05	0.95
E	1.95	2.05	2.00
E2	1.40	1.60	1.50
e	—	—	0.65
L	0.25	0.35	0.30
L1	0.82	0.92	0.87
K1	—	—	0.305
K2	—	—	0.225
Z	—	—	0.20

All Dimensions in mm

Suggested Pad Layout

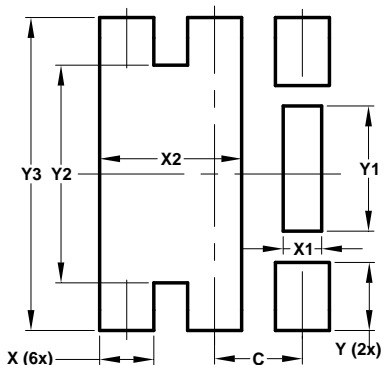

Dimensions	Value (in mm)
C	0.650
X	0.400
X1	0.285
X2	1.050
Y	0.500
Y1	0.920
Y2	1.600
Y3	2.300

**DMP4047LFDE****IMPORTANT NOTICE**

DIODES INCORPORATED MAKES NO WARRANTY OF ANY KIND, EXPRESS OR IMPLIED, WITH REGARDS TO THIS DOCUMENT, INCLUDING, BUT NOT LIMITED TO, THE IMPLIED WARRANTIES OF MERCHANTABILITY AND FITNESS FOR A PARTICULAR PURPOSE (AND THEIR EQUIVALENTS UNDER THE LAWS OF ANY JURISDICTION).

Diodes Incorporated and its subsidiaries reserve the right to make modifications, enhancements, improvements, corrections or other changes without further notice to this document and any product described herein. Diodes Incorporated does not assume any liability arising out of the application or use of this document or any product described herein; neither does Diodes Incorporated convey any license under its patent or trademark rights, nor the rights of others. Any Customer or user of this document or products described herein in such applications shall assume all risks of such use and will agree to hold Diodes Incorporated and all the companies whose products are represented on Diodes Incorporated website, harmless against all damages.

Diodes Incorporated does not warrant or accept any liability whatsoever in respect of any products purchased through unauthorized sales channel. Should Customers purchase or use Diodes Incorporated products for any unintended or unauthorized application, Customers shall indemnify and hold Diodes Incorporated and its representatives harmless against all claims, damages, expenses, and attorney fees arising out of, directly or indirectly, any claim of personal injury or death associated with such unintended or unauthorized application.

Products described herein may be covered by one or more United States, international or foreign patents pending. Product names and markings noted herein may also be covered by one or more United States, international or foreign trademarks.

LIFE SUPPORT

Diodes Incorporated products are specifically not authorized for use as critical components in life support devices or systems without the express written approval of the Chief Executive Officer of Diodes Incorporated. As used herein:

A. Life support devices or systems are devices or systems which:

1. are intended to implant into the body, or
2. support or sustain life and whose failure to perform when properly used in accordance with instructions for use provided in the labeling can be reasonably expected to result in significant injury to the user.

B. A critical component is any component in a life support device or system whose failure to perform can be reasonably expected to cause the failure of the life support device or to affect its safety or effectiveness.

Customers represent that they have all necessary expertise in the safety and regulatory ramifications of their life support devices or systems, and acknowledge and agree that they are solely responsible for all legal, regulatory and safety-related requirements concerning their products and any use of Diodes Incorporated products in such safety-critical, life support devices or systems, notwithstanding any devices- or systems-related information or support that may be provided by Diodes Incorporated. Further, Customers must fully indemnify Diodes Incorporated and its representatives against any damages arising out of the use of Diodes Incorporated products in such safety-critical, life support devices or systems.

Copyright © 2012, Diodes Incorporated

www.diodes.com