

Excellent Integrated System Limited

Stocking Distributor

Click to view price, real time Inventory, Delivery & Lifecycle Information:

[Excelsys Technologies Ltd](#)
[XWC-01](#)

For any questions, you can email us directly:

sales@integrated-circuit.com

400W-800W



Medically Approved Ultra Low Noise Power Supply

Ultra-high efficiency 1U size



Ultra Low Noise Medical

PLUG & PLAY POWER next generation power solution

FEATURES & OPTIONS

- Low Acoustic noise 38.3dBA
- EN60601-1 3rd edition Approved
- Less than 300µA leakage current
- 150µA option available
- 4000VAC isolation
- Ultra high efficiency, up to 89%
- Extra low profile: 1U height (40mm)
- Plug & Play Power - allows fast custom configuration
- Individual output control signals
- All outputs fully floating
- Series / Parallel of multiple outputs
- Few electrolytic capacitors (all long life)
- 5V bias standby voltage provided
- Standard Xgen product options include:
 Conformal Coating, Low Acoustic Noise, Low Leakage Current, Extra Ruggedisation, Connector, Cabling & Mounting options, Thermal Signals and Reverse Fans. See Section 4.10 for more information

APPLICATIONS INCLUDE

- Clinical diagnostic equipment
- Medical lasers
- Dialysis equipment
- For Standard applications see XB

EFFICIENCY (typical)

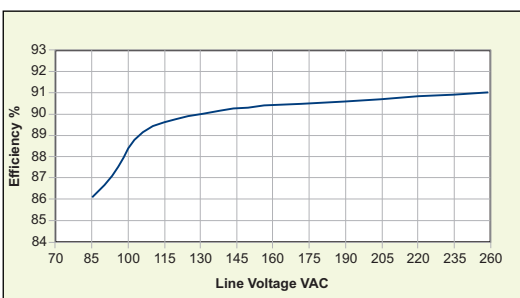

The XW family of medically approved Ultra Low Noise power supplies provides up to 800W in an extremely compact 1U package. Providing up to 12 isolated DC outputs, the XW family employs innovative plug & play architecture allowing users to instantly configure a custom power solution in less than 5 minutes!

The XW family consists of 3 *powerPacs* ranging in power levels from 400W to 800W peak and 7 *powerMods* DC output modules. Simply select the appropriate *powerPac* and up to 6 *powerMods* from the tables below to complete your custom power supply.

The XW family boasts ultra-high efficiencies (up to 90%). The significant system space savings and reduced heat dissipation radically simplify system design.

All configurations carry full safety agency approvals including UL60601-1, EN60601-1 3rd Edition and are CE marked.

powerMods

| MODEL | V _{min} V _{trim} | V _{nom} V _{pot} | V _{max} | I _{max} | Watts | |
|--------|---------------------------------------|--------------------------------------|------------------|------------------|--------|------|
| Xg1 | 1.0 | 1.5 | 2.5 | 3.6 | 41.6A | 104W |
| Xg2 | 1.5 | 3.2 | 5.0 | 6.0 | 33.2A | 166W |
| Xg3 | 4.0 | 6.0 | 12.0 | 15.0 | 16.67A | 200W |
| Xg4 | 8.0 | 12.0 | 24.0 | 30.0 | 8.33A | 200W |
| Xg5 | 8.0 | 24.0 | 48.0 | 58.0 | 5A | 240W |
| Xg7 | | 5.0 | 24.0 | 28.0 | 4.17A | 100W |
| Xg8 v1 | | 5.0 | 24.0 | 28.0 | 2.5A | 60W |
| v2 | | 5.0 | 24.0 | 28.0 | 2.5A | 60W |

powerPacs

| | MODEL | Watts |
|----|-------|-------|
| XW | XWA | 400W |
| | XWB | 600W |
| | XWC | 800W |

powerMod Maximum Power Outputs (W) have been derated to operate with XW range of Ultra Low-Noise Power Supplies. See Section 4.11 Xgen Designers' Manual for full derating details.

MECHANICAL SPECIFICATIONS

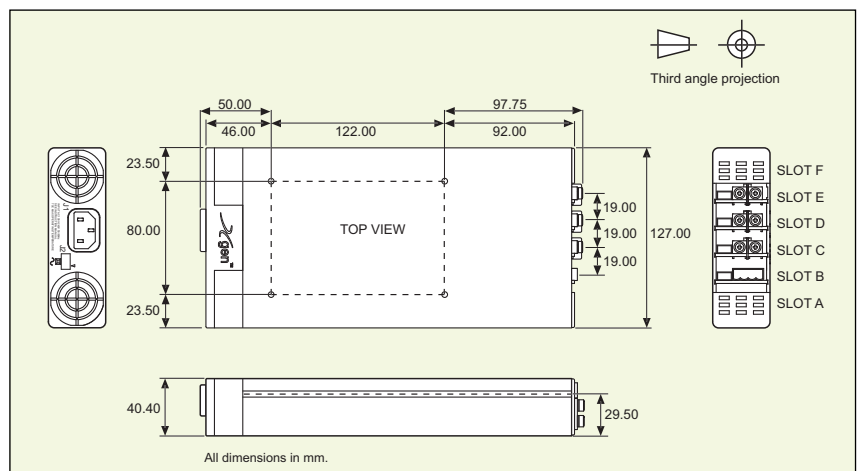

SPECIFICATION applies to configured units consisting of **powerMods** plugged into the appropriate **powerPac**

| INPUT | | | | | |
|------------------------------------|---|---|-----------|---------------------------------|--------------|
| Parameter | Conditions/Description | Min | Nom | Max | Units |
| Input Voltage Range | Universal Input 47-63Hz. Contact factory for 440Hz operation | 85 120 | | 264 380 | VAC VDC |
| Power Rating | XWA:400W, XWB:600W, XWC:800W See Section 4.11 for line voltage deratings | | | | |
| Input Current | XWA XWB XWC | 85VAC in 400W out 85VAC in 600W out 85VAC in 625W out | | 7.5 9.5 11.5 | A A A |
| Inrush Current | 230VAC @ 25°C | | | 25 | A |
| Undervoltage Lockout | Shutdown | 65 | | 74 | VAC |
| Fusing | XWA XWB XWC | 250V 250V 250V | | F8A HRC F10A HRC F12A HRC | |
| OUTPUT | | | | | |
| Parameter | Conditions/Description | Min | Nom | Max | Units |
| powerMod Power | As per <i>powerMod</i> table | | | | |
| Output Adjustment Range | Manual: Multi-turn potentiometer. As per <i>powerMod</i> table Electronic: See Section 4.6 | | | | |
| Minimum Load | | | 0 | | A |
| Line Regulation | For ±10% change from nominal line | | | ±0.1 | % |
| Load & Cross Regulation | For 25% to 75% load change | | | ±0.2 | % |
| Transient Response | For 25% to 75% load change Voltage Deviation Settling Time | | | 10 250 | % µs |
| Ripple and Noise | 20MHz 100mV or 1.0% pk-pk | | | | |
| Overvoltage Protection | Two-level. 1st level: Vset Tracking. 2nd level: Vmax (Latching) | 110 | | 125 | % |
| Overcurrent Protection | Straight line with hiccup activation at <30% of Vnom See Section 4.6 | 110 | | 120 | % |
| Remote Sense | Max. line drop compensation. (except Xg7, Xg8) | | | 0.5 | VDC |
| Overshoot | | | | 2 | % |
| Turn-on Delay | From AC In / Enable signal XWA, XWB & XWC | | | 600 / 30 | ms |
| Rise Time | Monotonic | | | 5 | ms |
| Hold-up Time | For nominal output voltages at full load | 20 | | | ms |
| Output Isolation | Output to Output / Output to Chassis | 500 / 500 | | | VDC |
| GENERAL | | | | | |
| Parameter | Conditions/Description | Min | Nom | Max | Units |
| Isolation Voltage | Input to Output Input to Chassis | 4000 1500 | | | VAC VAC |
| Efficiency | 230VAC, 800W @ 24V | | 90 | | % |
| Safety Agency Approvals | EN60601-1 3rd Edition, UL60601-1, CSA601-1 UL File No. E230761 | | | | |
| Leakage Current | 250VAC, 60Hz, 25°C 250VAC, 60Hz, 25°C option 04 | | | 300 150 | µA µA |
| Signals | See Section 4.9 | | | | |
| Bias Supply | Always on. Current 250mA. 500mA option available | 4.8 | 5.0 | 5.2 | VDC |
| Reliability | Failures per million hours at 25°C and full load <i>powerMod</i> See Section 4.12. <i>powerPac</i> excludes fans <i>powerPac</i> | | | 0.98 0.92 | fpmh fpmh |
| EMC | | | | | |
| Parameter | Standard | Level | | Units | |
| Emissions | | | | | |
| Conducted | EN55011, EN55022, FCC | | Level B | | |
| Radiated | EN55011, EN55022, FCC | | Level B | | |
| Harmonic Distortion | EN61000-3-2 Class A | | Compliant | | |
| Flicker & Fluctuation | EN61000-3-3 | | Compliant | | |
| Immunity | | | | | |
| Electrostatic Discharge | EN61000-4-2 | | Level 2 | | |
| Radiated Immunity | EN61000-4-3 | | Level 3 | | |
| Fast Transients-Burst | EN61000-4-4 | | Level 3 | | |
| Input Line Surges | EN61000-4-5 | | Level 3 | | |
| Conducted Immunity | EN61000-4-6 | | Level 3 | | |
| Voltage Dips | EN61000-4-11 | | Compliant | | |
| ENVIRONMENTAL | | | | | |
| Parameter | Conditions/Description | Min | Nom | Max | Units |
| Operating Temperature | | -20 | | +70 | °C |
| Storage Temperature | | -40 | | +85 | °C |
| Derating | See Section 4.11 for full temperature deratings | | | | |
| Relative Humidity | Non-condensing | 5 | | 95 | %RH |
| Acoustic Noise | Measured from distance of 1m | | 38.3 | | dBA |
| Shock | 3000 Bumps, 10G (16ms) half sine | | | | |
| Vibration | 1.5G | 10 | | 200 | Hz |

NOTES

1. This product is not intended for use as a stand alone unit and must be installed by qualified personnel.
2. The specifications contained herein are believed to be correct at time of publication and are subject to change without notice.
3. When powering inductive or capacitive loads, it is recommended to use a blocking diode on the output.
4. All specifications at nominal input, full load, 25°C unless otherwise stated.
5. For section references above go to the Xgen Designers Manual.

Xgen Flexibility and Signals

For detailed information please refer to the Xgen Designers' Manual which is available on-line or contact Excelsys.

Voltage Adjustment

Output voltage can be adjusted in a number of ways:

1. On board multi turn potentiometer
2. Remote resistive programming (via Vtrim pin)
3. Remote voltage programming (via Vtrim pin)

Current Limit Adjustment

Output current limit can be Straight line or Foldback and can be adjusted via Itrim pin.

Parallel Connection

To achieve increased current capacity, simply parallel outputs using the standard parallel links.

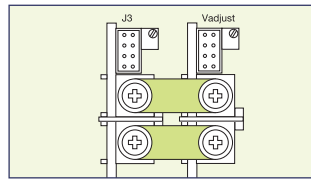

Parallel Links available to order.
Part Number XP1

Series Connection

To achieve increased output voltages, simply series outputs using standard series links, paying attention to the requirements to maintain SELV levels if required in your system.

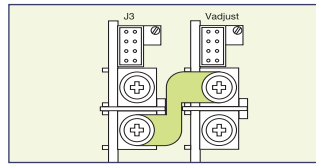

Series Links available. Part Number XS1

Remote Sensing

When the load is remote from the power supply, the remote sense pins may be used to compensate for drops in the power leads. Where the power cabling contributes significant dynamic impedance, see Xgen series Designers' Manual.

Bias Voltage

A SELV isolated bias (always on) voltage of 5V @ 250mA (30mA on XCE and XVE models) is provided on J2 pin 2 relative to J2 pin 1 (common) and may be used for miscellaneous control functions. 5V @ 500mA available on request.

Inhibit/Enable

Inhibiting may be implemented either globally or on a per module basis (*powerPac* or *powerMod* inhibiting). Reverse logic (enabling) may also be implemented.

AC Fail

Open collector signal indicating that the input voltage has failed or is less than 80Vac. This signal changes state giving 5ms of warning before loss of output regulation.

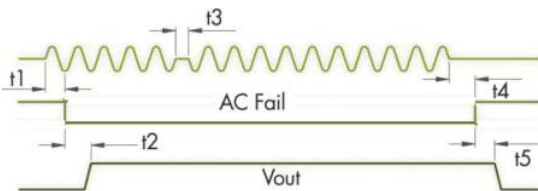

Power Good

Opto-isolated output signal indicates that the *powerMod* is operating correctly and output voltage is within normal band.

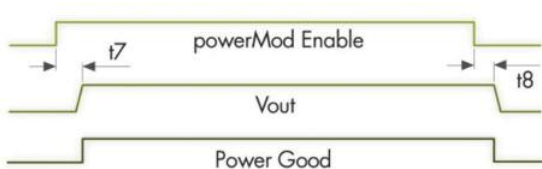

powerPac Options

Temperature Alarm (Option 01)

Open collector signal indicating that excessive temperature has been reached due to fan failure or operation beyond ratings. This signal is activated at least 10ms prior to system shutdown.

Fan Fail (Option 01)

Open collector signal indicating that at least one of the *powerPac* fans has failed. This does not cause power supply shutdown. The power supply will continue to operate until 10ms after the temperature alarm signal is generated.

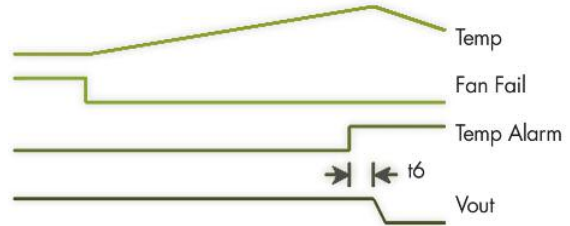

Reverse Fan (Option 02)

The Xgen series is available with reverse air flow direction. Contact Excelsys for derating details.

Ultra Low Leakage current (Option 04)

The Xgen is available with the option of Ultra Low Earth Leakage Current of <math>< 150\mu A</math> and is approved to EN60601-1 and UL60601-1 2nd and 3rd Editions.

Conformal Coating (Option C)

Xgen is available with conformal coating for harsh environments and MIL-COTs applications.

Ruggedised Option (Option R)

Xgen is available with extra ruggedisation for applications that are subject to extremes in shock and vibration.

Input cable Option (Option D)

3 Wire input mains cable. Input cables are 300mm in length and come supplied with fast on connectors.

Signal Connector Pinout

| Pin | J2 (<i>powerPac</i>) | J3 (<i>powerMod</i>) Type A | J3 (<i>powerMod</i>) Type B |
|-----|------------------------|-------------------------------|-------------------------------|
| 1 | common | +sense | +pg (V2) |
| 2 | +5V bias | -sense | -pg (V2) |
| 3 | | V trim | inhibit (V2) |
| 4 | ac fail | I trim | common (V2) |
| 5 | fan fail* | +inhibit/enable | +pg (V1) |
| 6 | global enable | -inhibit/enable | -pg (V1) |
| 7 | temp alarm* | +power good | inhibit (V1) |
| 8 | global inhibit | -power good | common (V1) |

*Option 01 only

TYPE A Xg1-Xg7

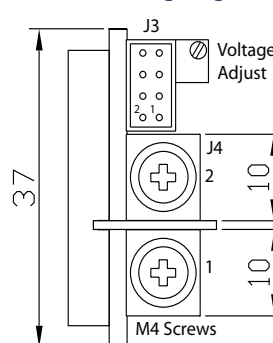

J4 Connector : M4 Screw

J3 Connector Mating Connector

Housing: Locking Molex 51110-0860
Non Locking Molex 51110-0850
Crimp Terminal: Molex p/n 50394

TYPE B : Xg8

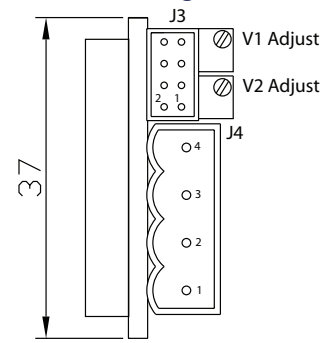

J4Connector : Camden 9200/4A

J3 Connector Mating Connector

Housing: Locking Molex 51110-0860
Non Locking Molex 51110-0850
Crimp Terminal: Molex p/n 50394

Xgen Plug and Play Power Supply Series 200W to 1340W

Xgen Product Selector

The Xgen series of user configurable power supplies with its unique plug and play architecture allows system designers to define and build 'instant' custom power solutions with industry leading 17W/in³ power density and up to 90% efficiency.

Xgen powerPacs

The application specific 4 slot and 6 slot *powerPacs* provide up to 12 isolated DC outputs from 200W up to 1340W. The table below summarises the *powerPacs* by application and power level. Please refer to the specific product datasheets for full specifications.

| Application | Slots | 200W | 400W | 600W | 700W | 750W | 800W | 900W | 1000W | 1200W | 1340W |
|----------------------|--------|------|------|------|------|------|------|------|-------|-------|-------|
| Standard | 4 Slot | XLA | XLB | XLC | | XLD | | | | | |
| | 6 Slot | | XCA | | XCB | | | XCC | XCD | XCE | |
| Medical | 4 Slot | XMA | XMB | XMC | | XMD | | | | | |
| | 6 Slot | | XVA | | XVB | | | XVC | XVD | XVE | |
| Low Noise Standard | 4 Slot | XKA | XKB | XKC | | | | | | | |
| | 6 Slot | | | XQA | | | | XQB | | XQC | |
| Low Noise Medical | 4 Slot | XRA | XRB | XRC | | | | | | | |
| | 6 Slot | | | XZA | | | | XZB | | XZC | |
| Ultra Quiet Standard | 4 Slot | XTA | XTB | | | | | | | | |
| | 6 Slot | | XBA | XBB | | | | XBC | | | |
| Ultra Quiet Medical | 4 Slot | XNA | XNB | | | | | | | | |
| | 6 Slot | | XWA | XWB | | | | XWC | | | |
| Hi-Temp | 6 Slot | | XHA | XHB | | | | | | | |

Xgen powerMods

High Efficiency Plug and Play DC output modules to provide a wide range of DC output voltages from 1.0V up to 58.0V.

| MODEL | Vmin Vtrim | Vnom Vpot | Vmax | Imax | Watts |
|--------|---------------|--------------|------|------|----------|
| Xg1 | 1.0 | 1.5 | 2.5 | 3.6 | 50A 125W |
| Xg2 | 1.5 | 3.2 | 5.0 | 6.0 | 40A 200W |
| Xg3 | 4.0 | 6.0 | 12.0 | 15.0 | 20A 240W |
| Xg4 | 8.0 | 12.0 | 24.0 | 30.0 | 10A 240W |
| Xg5 | 8.0 | 24.0 | 48.0 | 58.0 | 6A 288W |
| Xg7 | | 5.0 | 24.0 | 28.0 | 5A 120W |
| Xg8 v1 | | 5.0 | 24.0 | 28.0 | 3A 72W |
| v2 | | 5.0 | 24.0 | 28.0 | 3A 72W |

Standard Xgen product options include: Conformal Coating, Low Acoustic Noise, Low Leakage Current, Extra Ruggedisation, Connector, Cabling & Mounting options, Thermal Signals and Reverse Fans.



Configuring your Xgen

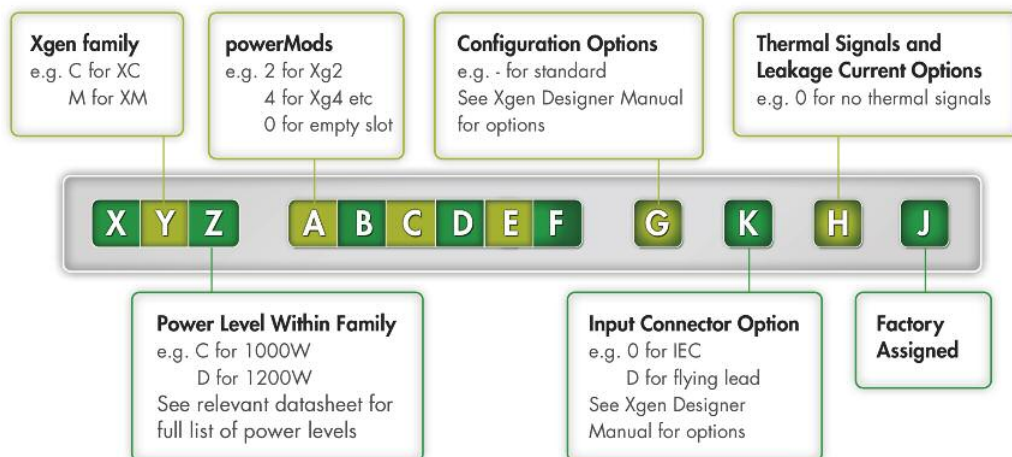

Example:

XVD234580-D4A contains

XVD *powerPac*:

1200W medically approved

Powermods

- Xg2:5V/40A,
- Xg3:12V/20A,
- Xg4:24V/10A,
- Xg5:48V/6A,
- Xg8:24V/3A, 24V/3A

Option D : Input cable option

Option 4: 150µA leakage current option

A: Factory assigned unique identifier