

## Excellent Integrated System Limited

Stocking Distributor

Click to view price, real time Inventory, Delivery & Lifecycle Information:

[Vishay Semiconductor/Diodes Division](#)  
[MBRB2545CTTRL](#)

For any questions, you can email us directly:

[sales@integrated-circuit.com](mailto:sales@integrated-circuit.com)



## MBRB25..CT/MBR25..CT-1

Vishay High Power Products

### Schottky Rectifier, 2 x 15 A

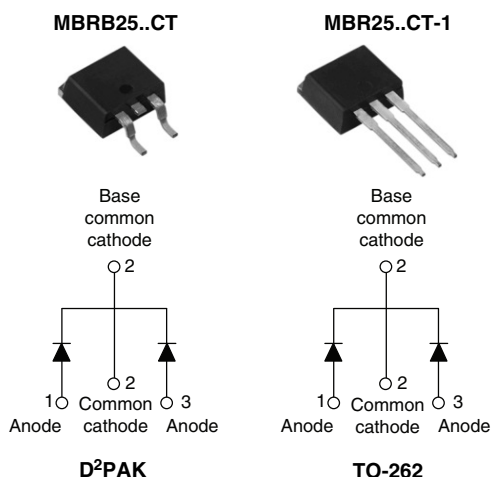

#### FEATURES

- 150 °C T<sub>J</sub> operation
- Center tap D<sup>2</sup>PAK and TO-262 packages
- Low forward voltage drop
- High frequency operation
- High purity, high temperature epoxy encapsulation for enhanced mechanical strength and moisture resistance
- Guard ring for enhanced ruggedness and long term reliability
- Designed and qualified for Q101 level

#### DESCRIPTION

This center tap Schottky rectifier has been optimized for low reverse leakage at high temperature. The proprietary barrier technology allows for reliable operation up to 150 °C junction temperature. Typical applications are in switching power supplies, converters, freewheeling diodes, and reverse battery protection.

#### PRODUCT SUMMARY

I <sub>F(AV)</sub>	2 x 15 A
V <sub>R</sub>	35/45 V
I <sub>RM</sub>	40 mA at 125 °C

#### MAJOR RATINGS AND CHARACTERISTICS

SYMBOL	CHARACTERISTICS	VALUES	UNITS
I <sub>F(AV)</sub>	Rectangular waveform (per device)	30	A
I <sub>FRM</sub>	T <sub>C</sub> = 130 °C (per leg)	30	
V <sub>RRM</sub>		35/45	V
I <sub>FSM</sub>	t <sub>p</sub> = 5 μs sine	1060	A
V <sub>F</sub>	30 Apk, T <sub>J</sub> = 125 °C	0.73	V
T <sub>J</sub>	Range	- 65 to 150	°C

#### VOLTAGE RATINGS

PARAMETER	SYMBOL	MBRB2535CT MBR2535CT-1	MBRB2545CT MBR2545CT-1	UNITS
Maximum DC reverse voltage	V <sub>R</sub>	35	45	V
Maximum working peak reverse voltage	V <sub>RWM</sub>			

#### ABSOLUTE MAXIMUM RATINGS

PARAMETER	SYMBOL	TEST CONDITIONS	VALUES	UNITS
Maximum average forward current	I <sub>F(AV)</sub>	T <sub>C</sub> = 130 °C, rated V <sub>R</sub>	15	A
			30	
Peak repetitive forward current per leg	I <sub>FRM</sub>	Rated V <sub>R</sub> , square wave, 20 kHz, T <sub>C</sub> = 130 °C	30	
Non-repetitive peak surge current	I <sub>FSM</sub>	5 μs sine or 3 μs rect. pulse	1060	A
		Surge applied at rated load conditions halfwave, single phase, 60 Hz	150	
Non-repetitive avalanche energy per leg	E <sub>AS</sub>	T <sub>J</sub> = 25 °C, I <sub>AS</sub> = 2 A, L = 8 mH	16	mJ
Repetitive avalanche current per leg	I <sub>AR</sub>	Current decaying linearly to zero in 1 μs Frequency limited by T <sub>J</sub> maximum V <sub>A</sub> = 1.5 x V <sub>R</sub> typical	2	A

# MBRB25..CT/MBR25..CT-1



Vishay High Power Products Schottky Rectifier, 2 x 15 A

ELECTRICAL SPECIFICATIONS					
PARAMETER	SYMBOL	TEST CONDITIONS		VALUES	UNITS
Maximum forward voltage drop	$V_{FM}^{(1)}$	30 A	$T_J = 25\text{ }^\circ\text{C}$	0.82	V
			$T_J = 125\text{ }^\circ\text{C}$	0.73	
Maximum instantaneous reverse current	$I_{RM}^{(1)}$	Rated DC voltage	$T_J = 25\text{ }^\circ\text{C}$	0.2	mA
			$T_J = 125\text{ }^\circ\text{C}$	40	
Threshold voltage	$V_{F(TO)}$	$T_J = T_J$ maximum		0.355	V
Forward slope resistance	$r_t$			12.3	m $\Omega$
Maximum junction capacitance	$C_T$	$V_R = 5\text{ }V_{DC}$ (test signal range 100 kHz to 1 MHz) 25 $^\circ\text{C}$		700	pF
Typical series inductance	$L_S$	Measured from top of terminal to mounting plane		8.0	nH
Maximum voltage rate of change	dV/dt	Rated $V_R$		10 000	V/ $\mu\text{s}$

**Note**

(1) Pulse width < 300  $\mu\text{s}$ , duty cycle < 2 %

THERMAL - MECHANICAL SPECIFICATIONS					
PARAMETER	SYMBOL	TEST CONDITIONS		VALUES	UNITS
Maximum junction temperature range	$T_J$			- 65 to 150	$^\circ\text{C}$
Maximum storage temperature range	$T_{Stg}$			- 65 to 175	
Maximum thermal resistance, junction to case per leg	$R_{thJC}$	DC operation		1.5	$^\circ\text{C/W}$
Typical thermal resistance, case to heatsink	$R_{thCS}$	Mounting surface, smooth and greased (Only for TO-262)		0.50	
Approximate weight				2	g
				0.07	oz.
Mounting torque	minimum	Non-lubricated threads		6 (5)	kgf · cm (lbf · in)
	maximum			12 (10)	
Marking device		Case style D <sup>2</sup> PAK		MBRB2535CT	
				MBRB2545CT	
		Case style TO-262		MBR2535CT-1	
				MBR2545CT-1	



**MBRB25..CT/MBR25..CT-1**

Schottky Rectifier, 2 x 15 A Vishay High Power Products

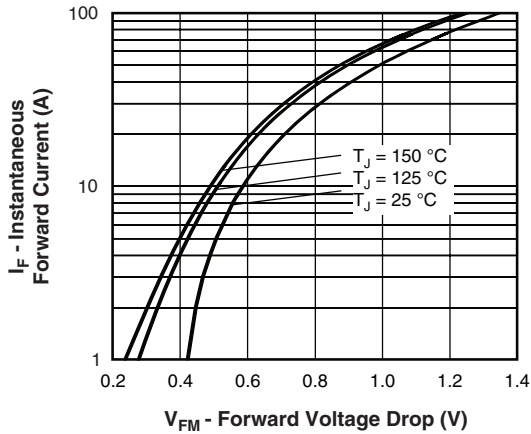

Fig. 1 - Maximum Forward Voltage Drop Characteristics (Per Leg)

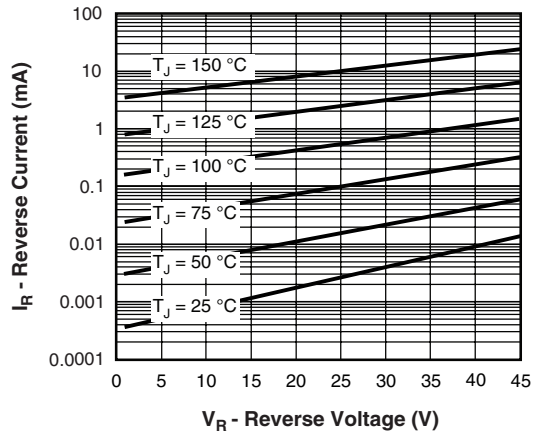

Fig. 2 - Typical Values of Reverse Current vs. Reverse Voltage (Per Leg)

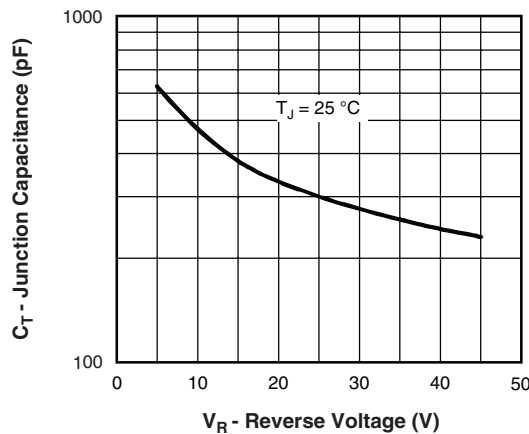

Fig. 3 - Typical Junction Capacitance vs. Reverse Voltage (Per Leg)

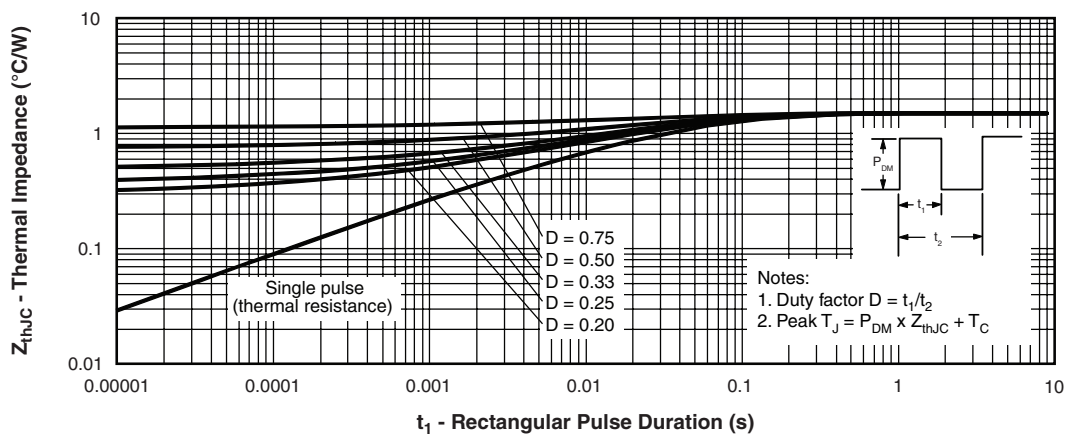

Fig. 4 - Maximum Thermal Impedance  $Z_{thJC}$  Characteristics (Per Leg)

# MBRB25..CT/MBR25..CT-1



Vishay High Power Products Schottky Rectifier, 2 x 15 A

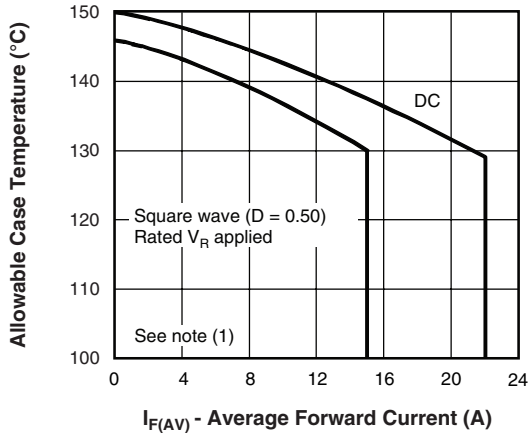

Fig. 5 - Maximum Allowable Case Temperature vs. Average Forward Current (Per Leg)

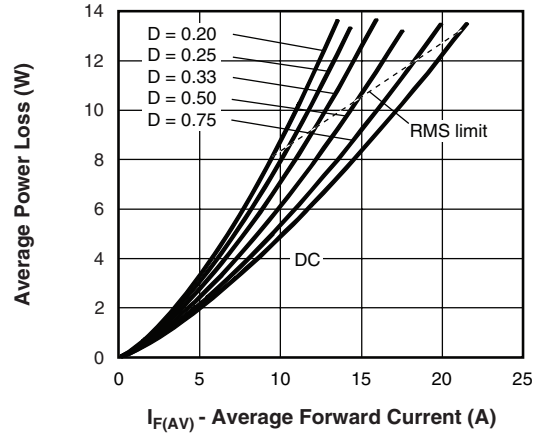

Fig. 6 - Forward Power Loss Characteristics (Per Leg)

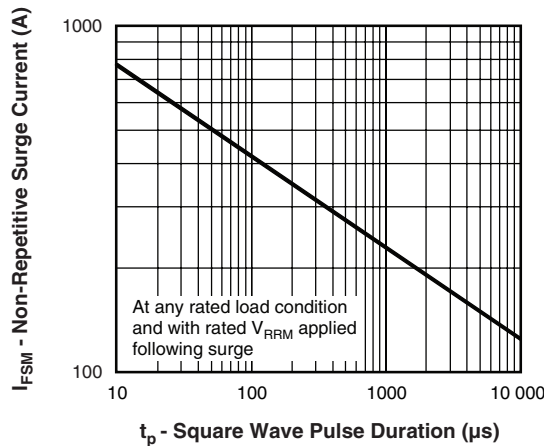

Fig. 7 - Maximum Non-Repetitive Surge Current (Per Leg)

**Note**

(1) Formula used:  $T_C = T_J - (Pd + Pd_{REV}) \times R_{thJC}$ ;  
 $Pd$  = Forward power loss =  $I_{F(AV)} \times V_{FM}$  at  $(I_{F(AV)}/D)$  (see fig. 6);  
 $Pd_{REV}$  = Inverse power loss =  $V_{R1} \times I_R (1 - D)$ ;  $I_R$  at  $V_{R1}$  = Rated  $V_R$



# MBRB25..CT/MBR25..CT-1

Schottky Rectifier, 2 x 15 A Vishay High Power Products

## ORDERING INFORMATION TABLE

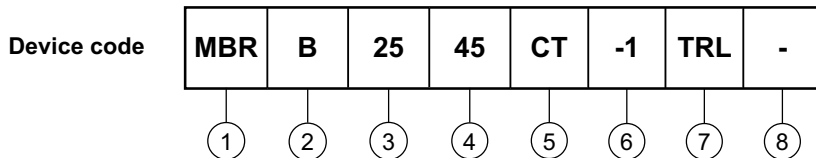

- 1** - Essential part number
- 2** -
  - B = D<sup>2</sup>PAK **6** None
  - None = TO-262 **6** = -1
- 3** - Current rating (25 = 25 A)
- 4** - Voltage ratings 35 = 35 V  
45 = 45 V
- 5** - CT = Essential part number
- 6** -
  - None = D<sup>2</sup>PAK **2** = B
  - -1 = TO-262 **2** None
- 7** -
  - None = Tube (50 pieces)
  - TRL = Tape and reel (left oriented - for D<sup>2</sup>PAK only)
  - TRR = Tape and reel (right oriented - for D<sup>2</sup>PAK only)
- 8** -
  - None = Standard production
  - PbF = Lead (Pb)-free (for TO-262 and D<sup>2</sup>PAK tube)
  - P = Lead (Pb)-free (for D<sup>2</sup>PAK TRR and TRL)

LINKS TO RELATED DOCUMENTS	
Dimensions	<a href="http://www.vishay.com/doc?95014">http://www.vishay.com/doc?95014</a>
Part marking information	<a href="http://www.vishay.com/doc?95008">http://www.vishay.com/doc?95008</a>
Packaging information	<a href="http://www.vishay.com/doc?95032">http://www.vishay.com/doc?95032</a>



## Legal Disclaimer Notice

---

Vishay

### Disclaimer

All product specifications and data are subject to change without notice.

Vishay Intertechnology, Inc., its affiliates, agents, and employees, and all persons acting on its or their behalf (collectively, "Vishay"), disclaim any and all liability for any errors, inaccuracies or incompleteness contained herein or in any other disclosure relating to any product.

Vishay disclaims any and all liability arising out of the use or application of any product described herein or of any information provided herein to the maximum extent permitted by law. The product specifications do not expand or otherwise modify Vishay's terms and conditions of purchase, including but not limited to the warranty expressed therein, which apply to these products.

No license, express or implied, by estoppel or otherwise, to any intellectual property rights is granted by this document or by any conduct of Vishay.

The products shown herein are not designed for use in medical, life-saving, or life-sustaining applications unless otherwise expressly indicated. Customers using or selling Vishay products not expressly indicated for use in such applications do so entirely at their own risk and agree to fully indemnify Vishay for any damages arising or resulting from such use or sale. Please contact authorized Vishay personnel to obtain written terms and conditions regarding products designed for such applications.

Product names and markings noted herein may be trademarks of their respective owners.