

Excellent Integrated System Limited

Stocking Distributor

Click to view price, real time Inventory, Delivery & Lifecycle Information:

[Honeywell Sensing and Productivity Solutions](#)
[EPM22BRR2ACX](#)

For any questions, you can email us directly:

sales@integrated-circuit.com

Interactive Catalog Supplements Catalog PDFs

If you need detailed product information, or help choosing the right product for your application, see our [Interactive Catalog](#). Use the [Interactive Catalog](#) to access the most complete and up-to-date information available.

The [Interactive Catalog](#) provides an extensive collection of product specifications, application data, and technical literature that can be searched based on criteria you select.

This PDF catalog information was published in November 2000.



Sensing and Control
**Interactive
Catalog...**

**Click this icon to try
the Interactive Catalog.**

Sensing and Control

Honeywell Inc.
11 West Spring Street
Freeport, IL 61032

www.honeywell.com/sensing

Manual Switches

Sealed Pushbutton Switches

EPM Series



FEATURES

- High-intensity LEDs indicate status changes – brilliant color display can be distinguished even under high ambient lighting conditions
- Soft-glow LED backlighted legends for low ambient viewing
- Rugged sealed construction withstands effects of shock and vibration – provides dependable switching/lighted display in severe environment applications
- Designed to comply with MIL-S-22885
- Suitable for use in NEMA 4 and 13 enclosures
- Low travel (.030 in. max.), with tactile feedback for definite feel of switching action
- Front-of-panel, hard mounting
- Compact size
- Field-replaceable legends
- UL recognized, CSA certified, and MIL-S-8805 qualified basic switches
- EPM22 electronic control and EPM32 power duty switching for electrical flexibility
- Matching EPM41 indicators for uniform panel appearance
- Choice of two housing styles:
 - Type C: Standard sealed EPM housings
 - Type B: Enhanced sealed EPM housings with IR filters for vehicle lighting security, designed to MIL-STD-461 (EMI shielding), NBC compliance per AR70-71

EPM Series Sealed Pushbutton Switches meet high-performance needs for rugged, compact size sealed switches that are exposed to water, oil, cleaning solvents, and many industrial chemicals. They provide long, reliable operating life under conditions of high shock and vibration in severe environment applications.

In addition to being built to stand up to demanding environments, EPM switches adhere to good human factors principles. The design combines low travel with high tactile feedback and meets arctic glove requirements. Raised barriers on the bezel enhance finger positioning and help prevent inadvertent operation of two abutting units at one push. Lighted display options provide further application versatility.

LED ILLUMINATION

Long-life LEDs enable reliable illumination. They resist effects of shock and vibration, reducing service and maintenance requirements. (Unlighted versions are also available.)

The following lighting functions can be furnished: High-intensity display using two LEDs to create a brilliant light signal that can be distinguished under high ambient conditions, and/or a pair of LEDs which softly backlight the legend for viewing under low ambient conditions.

There is a choice of red, green or yellow LEDs. Matching indicators, which provide lighted display only, complement the switches to help present a uniform panel design.

ELECTRICAL FLEXIBILITY

EPM switches can be furnished with one or two SPDT basics. EPM22 electronic control switches handle up to 1 amp, EPM32 power duty switches up to 7 amps.

EASY TO INSTALL

Front panel hard-mounting is quick and easy. Only a screwdriver is needed to tighten the swing-out mounting lugs, which securely lock and seal the unit in the panel. Though the cover/bracket simply snaps onto the housing, it has inherent tamper resistance. The cover can be removed intentionally with a small screwdriver (or other tool) to add or change legends.

EPM's 3/4-inch square panel cutout on 1-inch centers is suited to row, column, or matrix arrays.

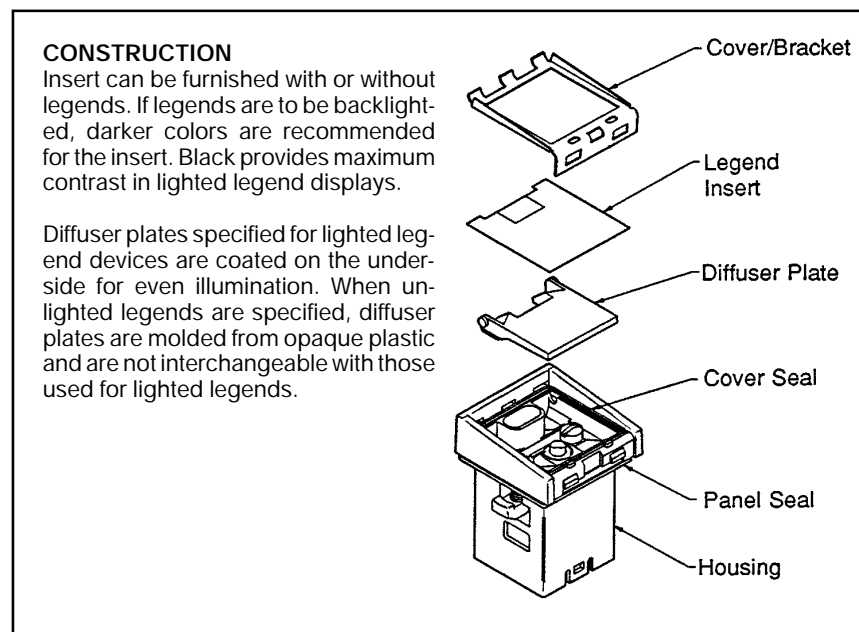

Manuals

Manual Switches

Sealed Pushbutton Switches

EPM Series

SPECIFICATIONS

Environmental	Operating Temperature	-40 to 85°C (-40 to 185°F)
	Storage Temperature	-54 to 85°C (-65 to 185°C)
	Seals	Viton bezel-to-panel gasket seal and neoprene cover seal
	Protection	NEMA 4 and 13
Mechanical	Total Travel	.030 in. (0,76 mm) max.
	Operating Force	20 to 60 oz. (5,56 to 16,7 N) typical
	Contact arrangement	1 or 2 SPDT
Electrical	Electrical rating	EPM22/24 switches - 28 VDC: .5 amp ind., 1 amp res. (sea level or 50,000 ft.), 2 amps max. inrush. 1 amp, 125 VAC (UL code L22). EPM32/34 switches - 28 VDC: 4 amps ind., 7 amps res. (sea level), 2.5 amps ind., 4 amps res. (50,000 ft). 115 VAC, 60 Hz: 7 amps res. or ind. (sea level).

EPM22/32 SWITCHES WITH SINGLE INDICATOR ORDER GUIDE

EPM22B	Y	R	6	AC	L
Housing Type and Switch Contacts	Legend Color ¹	Hi-Intensity Indicator Color	Switch and LED Terminals	Circuitry Code	Insert Type
Standard Type C Sealed Housing: EPM22C (Gold Contacts) EPM32C Silver Contacts Enhanced Type B Sealed Housing, with IR filters, EMI shielding & NBC compliance: EPM22B (Gold Contacts) EPM32B (Silver Contacts)	R Red Y Yellow G Green X No LED	R Red Y Yellow G Green X No LED	2 Printed Circuit 6 Hook style LED terminals and solder T2 switch terminals	AC 1-Pole BC 2-Pole (All are momentary action)	L Legended insert. Use Legend Order Sheet FO-43973 to designate insert color and legend. X No insert furnished. ² Unlegended insert: ¹ B Blue R Red Y Yellow G Green W White K Black

- When specifying Legend Color (R, Y, G), the insert Type suffix letter must be either: L (legended insert), or X (no insert furnished).
- To order insert separately, see EPM95 order guide.

Example: EPM22BYR6ACL

Enhanced Type B Sealed housing, gold contacts; high-intensity single indicator red lighted display and yellow legend backlighting, hook style LED terminals and solder T2 switch terminals; 1-pole circuitry, momentary action, furnished with legended insert, as specified in FO-43973.

Manual Switches

Sealed Pushbutton Switches

EPM Series

EPM24B	Y	D	6	AC	L																														
Housing Type and Switch Contacts Standard Type C Sealed Housing: EPM24C (Gold Contacts) EPM34C (Silver Contacts) Enhanced Type B Sealed Housing, incl. IR filters, EMI shielding & NBC compliance: EPM24B (Gold Contacts) EPM34B (Silver Contacts)	Legend Color¹ R Red Y Yellow G Green X No LED	Hi-Intensity Indicator Colors <table border="1"> <thead> <tr> <th>Color Code</th> <th>Upper LED</th> <th>Lower LED</th> </tr> </thead> <tbody> <tr><td>R</td><td>Red</td><td>Red</td></tr> <tr><td>Y</td><td>Yellow</td><td>Yellow</td></tr> <tr><td>G</td><td>Green</td><td>Green</td></tr> <tr><td>F</td><td>Red</td><td>Green</td></tr> <tr><td>A</td><td>Yellow</td><td>Green</td></tr> <tr><td>B</td><td>Yellow</td><td>Red</td></tr> <tr><td>C</td><td>Green</td><td>Yellow</td></tr> <tr><td>D</td><td>Green</td><td>Red</td></tr> <tr><td>E</td><td>Red</td><td>Yellow</td></tr> </tbody> </table>	Color Code	Upper LED	Lower LED	R	Red	Red	Y	Yellow	Yellow	G	Green	Green	F	Red	Green	A	Yellow	Green	B	Yellow	Red	C	Green	Yellow	D	Green	Red	E	Red	Yellow	Switch and LED Terminals 2 Printed Circuit 6 Hook style LED terminals and solder T2 switch terminals	Circuitry Code AC 1-Pole BC 2-Pole (All are momentary action)	Insert Type L Legended insert. Use Legend Order Sheet FO-43973 to designate insert color and legend. X No insert furnished. ² Unlegended Insert: ¹ B Blue R Red G Green W White K Black
Color Code	Upper LED	Lower LED																																	
R	Red	Red																																	
Y	Yellow	Yellow																																	
G	Green	Green																																	
F	Red	Green																																	
A	Yellow	Green																																	
B	Yellow	Red																																	
C	Green	Yellow																																	
D	Green	Red																																	
E	Red	Yellow																																	

1. When specifying Legend Color (R, Y, G), the insert Type suffix letter must be either: **L** (legended insert), or **X** (no insert furnished).
2. To order insert separately, see EPM97 order guide.
- Example: EPM24BYD6ACL**
 Enhanced Type **B** Sealed housing, gold contacts; yellow legend backlighting; high-intensity dual indicator green/red lighted display; hook style LED terminals and solder T2 switch terminals; 1-pole momentary action, furnished with legended insert, as specified in FO-43973.

EPM41B	Y	R	2	L
Housing Type and Switch Contacts Standard Type C Sealed Housing: EPM41C Enhanced Type B Sealed Housing with IR filters, EMI shielding & NBC compliance: EPM41B	Legend Color¹ R Red Y Yellow G Green X No LED	Hi-Intensity Indicator Color R Red Y Yellow G Green X No LED	LED Terminals 2 Printed Circuit 6 Hook style	Insert Type L Legended insert. Use Legend Order Sheet FO-43973 to designate insert color and legend. X No insert furnished. ² Unlegended Insert: ¹ B Blue R Red Y Yellow G Green W White B Black

1. When specifying Legend Color (R, Y, G), the insert Type suffix letter must be either: **L** (legended insert), or **X** (no insert furnished).
2. To order insert separately, see EPM95 order guide.
- Example: EPM41BYR2L**
 Enhanced Type **B** Sealed housing; high-intensity single indicator red lighted display and yellow legend backlighting, printed circuit LED and switch terminals; furnished with legended insert, as specified in FO-43973.

Manuals

Manual Switches

EPM Series

Sealed Pushbutton Switches

EPM44 DUAL INDICATORS (NO SWITCHES) ORDER GUIDE

EPM44B	Y	D	2	L																														
Housing Type and Switch Contacts	Legend Color¹	Hi-Intensity Dual Indicator Colors	LED Terminals	Legend Insert Type																														
Standard Type C Sealed Housing: EPM44C	R Red Y Yellow G Green X No LED	<table border="1"> <thead> <tr> <th>Color Code</th> <th>Upper LED</th> <th>Lower LED</th> </tr> </thead> <tbody> <tr><td>R</td><td>Red</td><td>Red</td></tr> <tr><td>Y</td><td>Yellow</td><td>Yellow</td></tr> <tr><td>G</td><td>Green</td><td>Green</td></tr> <tr><td>F</td><td>Red</td><td>Green</td></tr> <tr><td>A</td><td>Yellow</td><td>Green</td></tr> <tr><td>B</td><td>Yellow</td><td>Red</td></tr> <tr><td>C</td><td>Green</td><td>Yellow</td></tr> <tr><td>D</td><td>Green</td><td>Red</td></tr> <tr><td>E</td><td>Red</td><td>Yellow</td></tr> </tbody> </table>	Color Code	Upper LED	Lower LED	R	Red	Red	Y	Yellow	Yellow	G	Green	Green	F	Red	Green	A	Yellow	Green	B	Yellow	Red	C	Green	Yellow	D	Green	Red	E	Red	Yellow	2 Printed Circuit 6 Hook style	L Legended insert. Use Legend Order Sheet FO-43973 to designate insert color and legend. X No insert furnished. ² Unlegended Insert: ¹ B Blue R Red G Green W White K Black
Color Code	Upper LED	Lower LED																																
R	Red	Red																																
Y	Yellow	Yellow																																
G	Green	Green																																
F	Red	Green																																
A	Yellow	Green																																
B	Yellow	Red																																
C	Green	Yellow																																
D	Green	Red																																
E	Red	Yellow																																

- When specifying Legend Color (R, Y, G), the insert Type suffix letter must be either: L (legended insert), or X (no insert furnished).
- To order insert separately, see EPM97 order guide.

Example: EPM44BYD2L
Enhanced Type B Sealed housing; yellow legend backlighting; high-intensity dual indicator green/red display; printed circuit LED and switch terminals; furnished with legended insert, as specified in FO-43973.

HOW TO ORDER INSERTS SEPARATELY

Legended inserts: To order inserts legended by MICRO SWITCH as separate items, order Catalog Listing EPM94, and use Legend Order Sheet to specify the insert color and desired legend. **Unlegended inserts:** Use order guide below to order inserts without legends.

EPM95 UNLEGENDED INSERTS ORDER GUIDE

Unlegended inserts can be furnished with or without a display window for hi-intensity LED lighting.

Color	Inserts for Type B Housings:		Inserts For Type C Housings:	
	With window	Without window	With window	Without window
Blue	EPM95BBW	EPM95BBN	EPM95CBW	EPM95CBN
Green	EPM95BGW	EPM95BGN	EPM95CGW	EPM95CGN
Red	EPM95BRW	EPM95BRN	EPM95CRW	EPM95CRN
White	EPM95BWW	EPM95BWN	EPM95CWW	EPM95CWN
Yellow	EPM95BYW	EPM95BYN	EPM95CYW	EPM95CYN
Black	EPM95BKW	EPM95BKN	EPM95CKW	EPM95CKN
Gray	EPM95BPW	EPM95BPN	EPM95CPW	EPM95CPN

EPM97 INSERTS FOR DUAL INDICATOR DEVICES

Color	Inserts for Type B Housings:		Inserts For Type C Housings:	
	With window	Without window	With window	Without window
Blue	EPM97BBW	EPM97BBN	EPM97CBW	EPM97CBN
Green	EPM97BGW	EPM97BGN	EPM97CGW	EPM97CGN
Red	EPM97BRW	EPM97BRN	EPM97CRW	EPM97CRN
White	EPM97BWW	EPM97BWN	EPM97CWW	EPM97CWN
Yellow	EPM97BYW	EPM97BYN	EPM97CYW	EPM97CYN
Black	EPM97BKW	EPM97BKN	EPM97CKW	EPM97CKN
Gray	EPM97BPW	EPM97BPN	EPM97CPW	EPM97CPN

Manual Switches

Sealed Pushbutton Switches

EPM Series



EPM Series – Legend Order Sheet

MICRO SWITCH

Instructions:

1. Enter complete **catalog listing** at right. (Only one catalog listing per legend order sheet).
2. Enter **quantity** for this order and indicate est. annual use.
3. Enter **style**. (Be consistent with catalog listing in regard to lighted and non-lighted legends and high intensity LED).
4. and 5. Enter **area(s)** and print **legend(s)** corresponding to proper area(s). (Do not exceed the maximum number of characters per area).
6. Designate **legend color** for each legend. (If legends are to be lighted, color must be translucent. If legends are not to be lighted, indicate either black or white).
7. Designate **character size** for each area. (Be consistent with available sizes for style entered. If a special legend is desired, contact MICRO SWITCH for assistance).
8. Enter **background color** (letter) using chart below:

Internal Use Only:

Job Number:

Station Number:

Parylene Coat?:

Reference P/N:

Catalog Listing **EPM**

Customer P.O. No. _____ Customer Drawing No. _____

MICRO SWITCH Sales Order _____ Line No. _____ Sched. _____

Customer: _____

Address: _____

Prepared by: _____

Phone: _____

R - Red	B - Blue	W - White
Y - Yellow	K - Black	*Special - Contact MICRO SWITCH
G - Green	P - Gray	

Non-lighted Legends - without high intensity LED Display

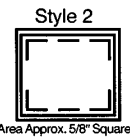
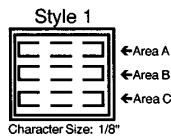

Lighted or Non-Lighted-Without Indicator LED Display:

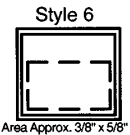
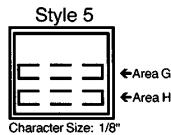
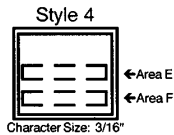
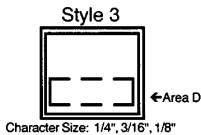

Lighted or Non-Lighted-With Indicator LED Display:

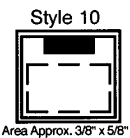
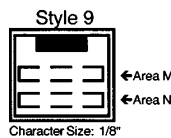
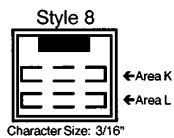
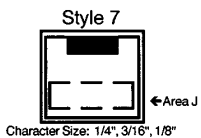

Lighted or Non-Lighted -

Dual Indicator LED Display:

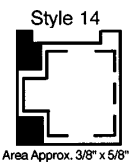
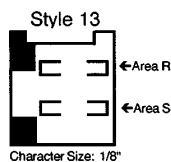
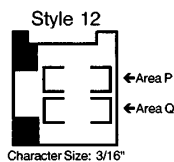
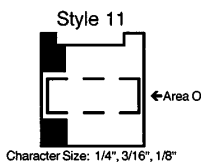

*Special legends will require additional cost and extended delivery time. Contact MICRO SWITCH (artwork needed).

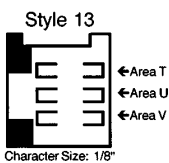

Quantity		Style	Area(s)	Legend - Max Characters/Area 1/4"-3, 3/16"-4, 1/8"-7 Using only one "M" or "W"	Legend Color			Character Size			Back-ground Color
This Order	Est. Annual				Lighted	Unlighted	1/4"	3/16"	1/8"	Special	
					Trans	Black	White				

F0-43973-C

Manuals

Manual Switches

Sealed Pushbutton Switches

EPM Series

MOUNTING DIMENSIONS (For reference only)

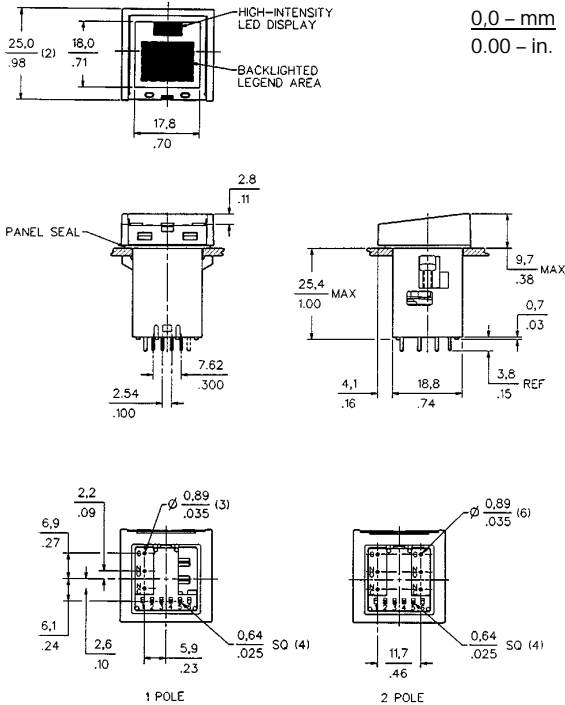

Panel Cutout

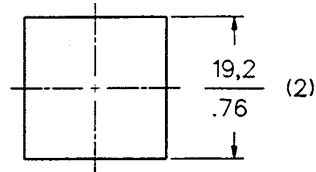

Panel thickness: .063 to .189 in.
(1,6 to 4,8 mm)

Center-to-center: 1 in. (25,4 mm)
rows or columns

Circuit Diagram

Switch Circuitry LED Circuitry

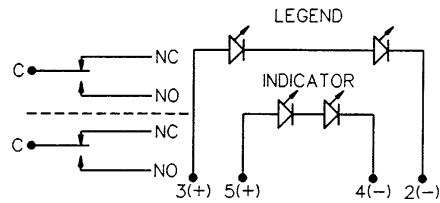

LED Application Data

External resistors should be added to maintain the LED current at 30 mA max., 20 mA typical. A minimum of 10 VDC open circuit voltage with an appropriate series resistance be used to drive the LEDs. This minimized the effect of temperature (current variation) on forward voltage of the LEDs. The example below illustrates a simple DC circuit and the equation used to determine the value of the series resistance.

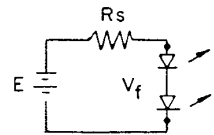

$$R_s = \frac{E - V_f}{I_f}$$

Where: R_s = Series Resistance
 E = Supply
 V_f = Forward Voltage of LED
 I_f = Circuit Current

Example: $R_s = \frac{10 - 4.4}{.020} = 280 \text{ ohms}$

For: $E = 10 \text{ volts}$
 $V_f = 4.4 \text{ volts}$
 $I_f = .020 \text{ amp}$

Characteristics: LED forward voltage @ .020 mA, V_f : Red, 4.4; yellow, 4.4; green, 4.6.

Terminal Detail

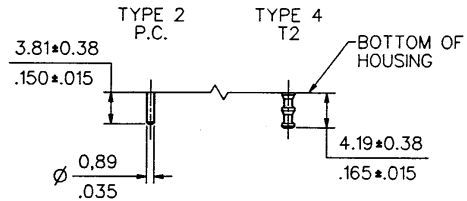

Notes:

1. LED terminals are Type 2 – PC only.
2. Mounting torque: 2 to 2½ in.-lbs.