

Excellent Integrated System Limited

Stocking Distributor

Click to view price, real time Inventory, Delivery & Lifecycle Information:

[Vishay Semiconductor/Diodes Division](#)
[VS-SD1100C04L](#)

For any questions, you can email us directly:

sales@integrated-circuit.com



www.vishay.com

VS-SD1100C..C Series

Vishay Semiconductors

Standard Recovery Diodes (Hockey PUK Version), 1400 A



B-43

FEATURES

- Wide current range
- High voltage ratings up to 3200 V
- High surge current capabilities
- Diffused junction
- Hockey PUK version
- Case style B-43
- Material categorization: For definitions of compliance please see www.vishay.com/doc?99912



RoHS
COMPLIANT

TYPICAL APPLICATIONS

- Converters
- Power supplies
- Machine tool controls
- High power drives
- Medium traction applications

PRODUCT SUMMARY

| | |
|-----------------------|--------------|
| $I_{F(AV)}$ | 1400 A |
| Package | B-43 |
| Circuit configuration | Single diode |

MAJOR RATINGS AND CHARACTERISTICS

| PARAMETER | TEST CONDITIONS | SD1100C..C | | UNITS |
|--------------|-----------------|-------------|--------------|-------------------|
| | | 04 to 20 | 25 to 32 | |
| $I_{F(AV)}$ | | 1400 | 1100 | A |
| | T_{hs} | 55 | 55 | °C |
| $I_{F(RMS)}$ | | 2500 | 2000 | A |
| | T_{hs} | 25 | 25 | °C |
| I_{FSM} | 50 Hz | 13 000 | 10 500 | A |
| | 60 Hz | 13 600 | 11 000 | |
| I^2t | 50 Hz | 846 | 551 | kA ² s |
| | 60 Hz | 772 | 503 | |
| V_{RRM} | Range | 400 to 2000 | 2500 to 3200 | V |
| T_J | | - 40 to 180 | - 40 to 150 | °C |

ELECTRICAL SPECIFICATIONS

VOLTAGE RATINGS

| TYPE NUMBER | VOLTAGE CODE | V_{RRM} , MAXIMUM REPETITIVE PEAK REVERSE VOLTAGE V | V_{RSM} , MAXIMUM NON-REPETITIVE PEAK REVERSE VOLTAGE V | I_{RRM} MAXIMUM AT $T_J = T_J$ MAXIMUM mA |
|---------------|--------------|----------------------------------------------------------|--------------------------------------------------------------|------------------------------------------------|
| VS-SD1100C..C | 04 | 400 | 500 | 35 |
| | 08 | 800 | 900 | |
| | 12 | 1200 | 1300 | |
| | 16 | 1600 | 1700 | |
| | 20 | 2000 | 2100 | |
| | 25 | 2500 | 2600 | |
| | 30 | 3000 | 3100 | |
| | 32 | 3200 | 3300 | |



| FORWARD CONDUCTION | | | | | | |
|---------------------------------------------------------|---------------|-----------------------------------------------------------------------------------------|----------------------------|------------|------------|--------------------|
| PARAMETER | SYMBOL | TEST CONDITIONS | | SD1100C..C | | UNITS |
| | | | | 04 to 20 | 25 to 32 | |
| Maximum average forward current at heatsink temperature | $I_{F(AV)}$ | 180° conduction, half sine wave Double side (single side) cooled | | 1400 (795) | 1100 (550) | A |
| | | | | 55 (85) | 55 (85) | °C |
| Maximum RMS forward current | $I_{F(RMS)}$ | 25 °C heatsink temperature double side cooled | | 2500 | 2000 | A |
| Maximum peak, one-cycle forward, non-repetitive current | I_{FSM} | t = 10 ms | No voltage reappplied | 13 000 | 10 500 | |
| | | t = 8.3 ms | No voltage reappplied | 13 600 | 11 000 | |
| | | t = 10 ms | 100 % V_{RRM} reappplied | 10 930 | 8830 | |
| | | t = 8.3 ms | 100 % V_{RRM} reappplied | 11 450 | 9250 | |
| Maximum I^2t for fusing | I^2t | t = 10 ms | No voltage reappplied | 846 | 551 | kA ² s |
| | | t = 8.3 ms | No voltage reappplied | 772 | 503 | |
| | | t = 10 ms | 100 % V_{RRM} reappplied | 598 | 390 | |
| | | t = 8.3 ms | 100 % V_{RRM} reappplied | 546 | 356 | |
| Maximum $I^2\sqrt{t}$ for fusing | $I^2\sqrt{t}$ | t = 0.1 to 10 ms, no voltage reappplied | | 8460 | 5510 | kA ² √s |
| Low level value of threshold voltage | $V_{F(TO)1}$ | $(16.7\% \times \pi \times I_{F(AV)} < I < \pi \times I_{F(AV)})$, $T_J = T_J$ maximum | | 0.78 | 0.84 | V |
| High level value of threshold voltage | $V_{F(TO)2}$ | $(I > \pi \times I_{F(AV)})$, $T_J = T_J$ maximum | | 0.94 | 0.88 | |
| Low level value of forward slope resistance | r_{f1} | $(16.7\% \times \pi \times I_{F(AV)} < I < \pi \times I_{F(AV)})$, $T_J = T_J$ maximum | | 0.35 | 0.40 | mΩ |
| High level value of forward slope resistance | r_{f2} | $(I > \pi \times I_{F(AV)})$, $T_J = T_J$ maximum | | 0.26 | 0.38 | |
| Maximum forward voltage drop | V_{FM} | $I_{pk} = 1500$ A, $T_J = T_J$ maximum $t_p = 10$ ms sinusoidal wave | | 1.31 | 1.44 | V |

| THERMAL AND MECHANICAL SPECIFICATIONS | | | | | | |
|--------------------------------------------------|--------------|-----------------------------------------------|--|-------------|-------------|--------|
| PARAMETER | SYMBOL | TEST CONDITIONS | | SD1100C..C | | UNITS |
| | | | | 04 to 20 | 25 to 32 | |
| Maximum junction operating temperature range | T_J | | | - 40 to 180 | - 40 to 150 | °C |
| Maximum storage temperature range | T_{Stg} | | | - 55 to 200 | | |
| Maximum thermal resistance, junction to heatsink | R_{thJ-hs} | DC operation single side cooled | | 0.076 | | K/W |
| | | DC operation double side cooled | | 0.038 | | |
| Mounting force, ± 10 % | | | | 9800 (1000) | | N (kg) |
| Approximate weight | | | | 83 | | g |
| Case style | | See dimensions - link at the end of datasheet | | B-43 | | |

| ΔR_{thJ-hs} CONDUCTION | | | | | | |
|--------------------------------|-----------------------|-------------|------------------------|-------------|---------------------|-------|
| CONDUCTION ANGLE | SINUSOIDAL CONDUCTION | | RECTANGULAR CONDUCTION | | TEST CONDITIONS | UNITS |
| | SINGLE SIDE | DOUBLE SIDE | SINGLE SIDE | DOUBLE SIDE | | |
| 180° | 0.007 | 0.007 | 0.005 | 0.005 | $T_J = T_J$ maximum | K/W |
| 120° | 0.008 | 0.008 | 0.008 | 0.008 | | |
| 90° | 0.010 | 0.010 | 0.011 | 0.011 | | |
| 60° | 0.015 | 0.015 | 0.016 | 0.016 | | |
| 30° | 0.026 | 0.026 | 0.026 | 0.026 | | |

Note

- The table above shows the increment of thermal resistance R_{thJ-hs} when devices operate at different conduction angles than DC



www.vishay.com

VS-SD1100C..C Series
Vishay Semiconductors

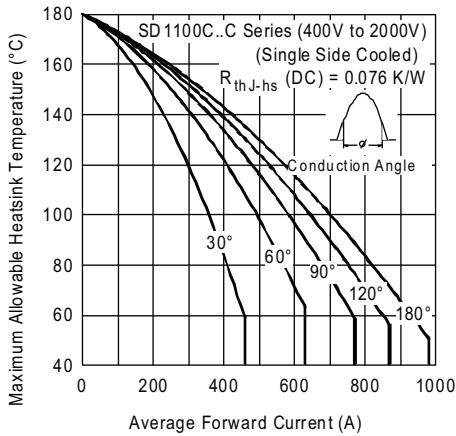

Fig. 1 - Current Ratings Characteristics

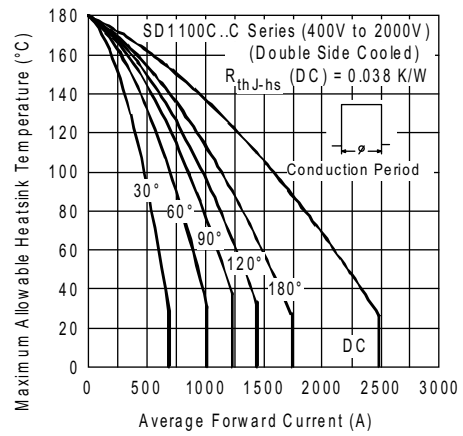

Fig. 4 - Current Ratings Characteristics

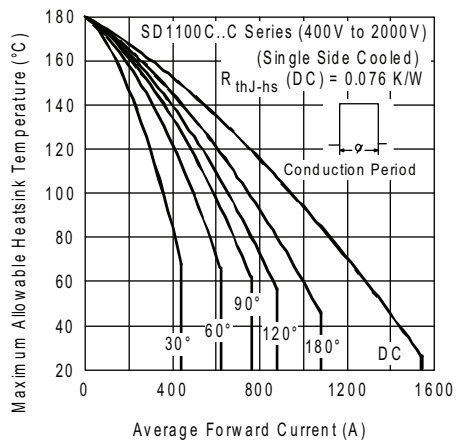

Fig. 2 - Current Ratings Characteristics

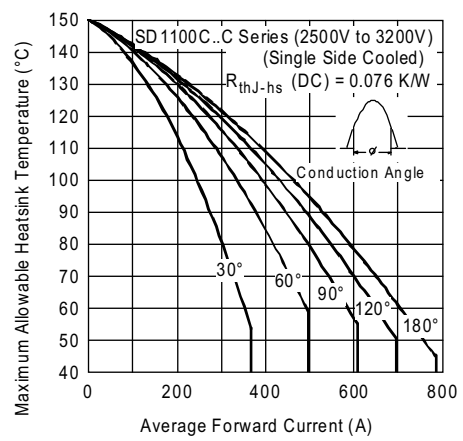

Fig. 5 - Current Ratings Characteristics

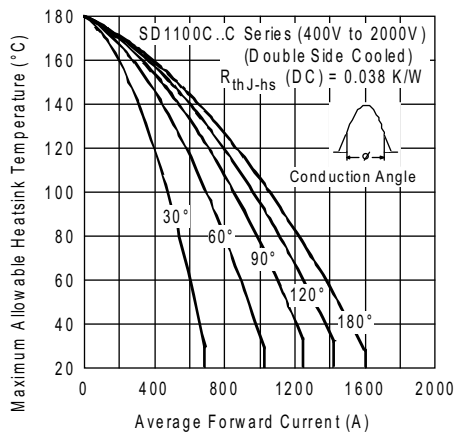

Fig. 3 - Current Ratings Characteristics

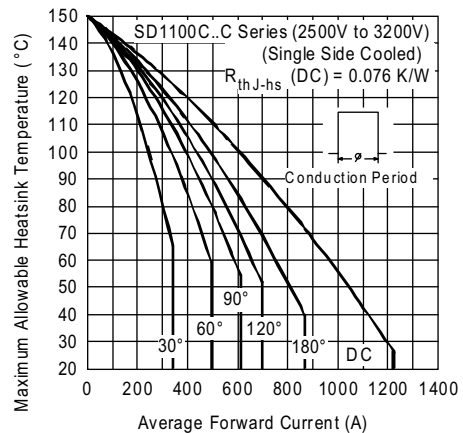

Fig. 6 - Current Ratings Characteristics



www.vishay.com

VS-SD1100C..C Series
Vishay Semiconductors

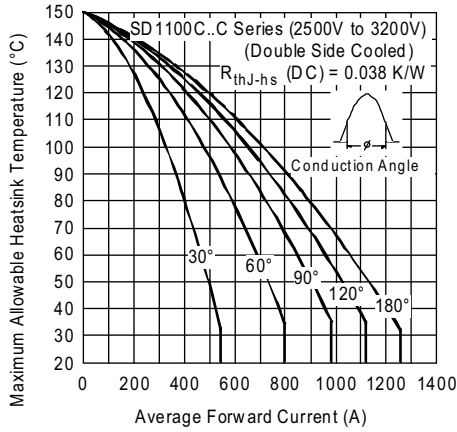

Fig. 7 - Current Ratings Characteristics

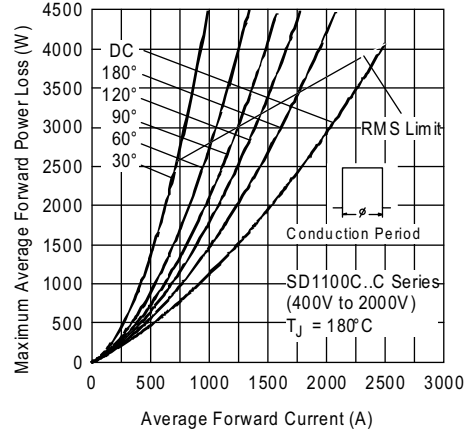

Fig. 10 - Forward Power Loss Characteristics

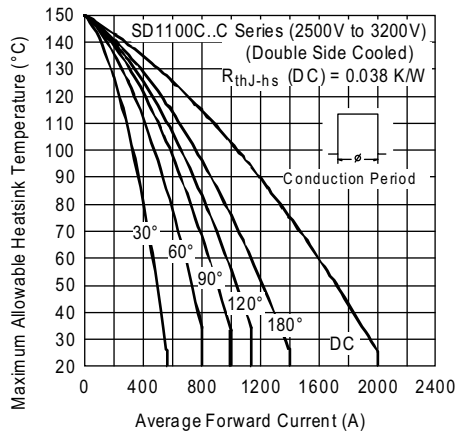

Fig. 8 - Current Ratings Characteristics

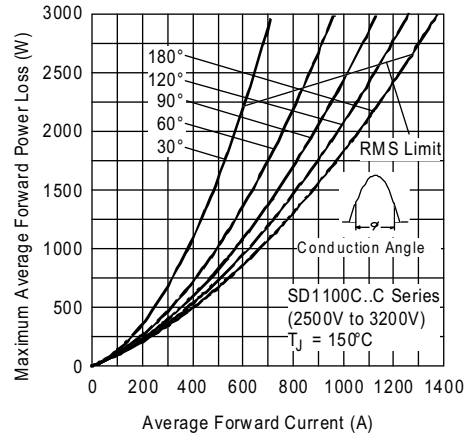

Fig. 11 - Forward Power Loss Characteristics

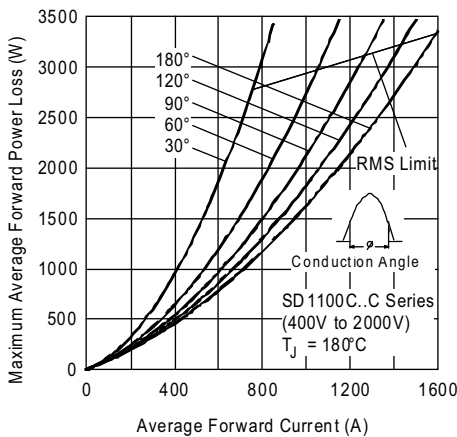

Fig. 9 - Forward Power Loss Characteristics

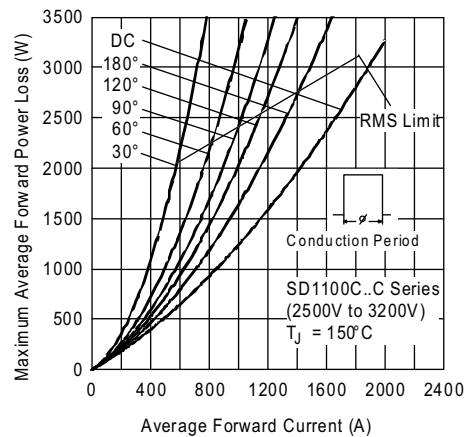

Fig. 12 - Forward Power Loss Characteristics



www.vishay.com

VS-SD1100C..C Series
Vishay Semiconductors

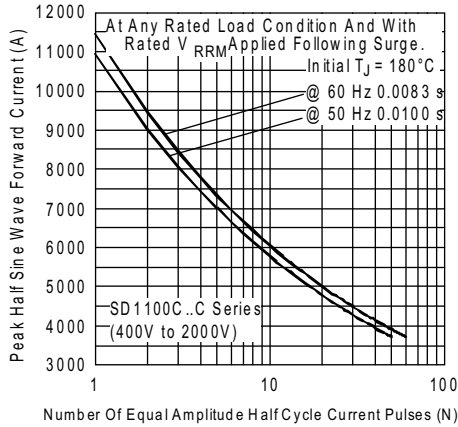

Fig. 13 - Maximum Non-Repetitive Surge Current Single and Double Side Cooled

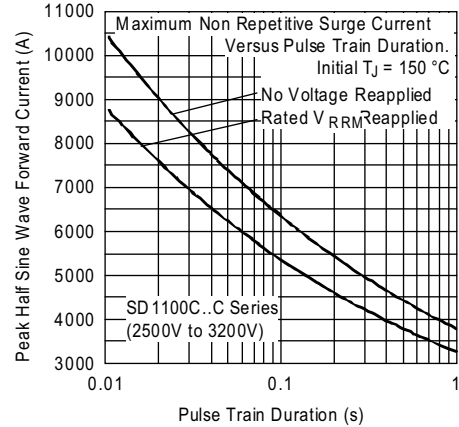

Fig. 16 - Maximum Non-Repetitive Surge Current Single and Double Side Cooled

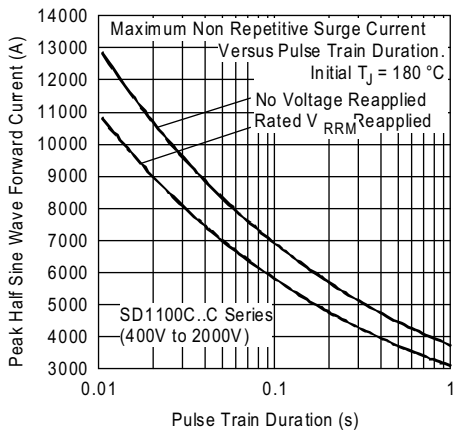

Fig. 14 - Maximum Non-Repetitive Surge Current Single and Double Side Cooled

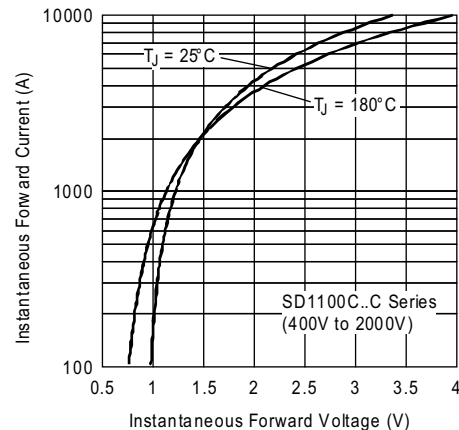

Fig. 17 - Forward Voltage Drop Characteristics

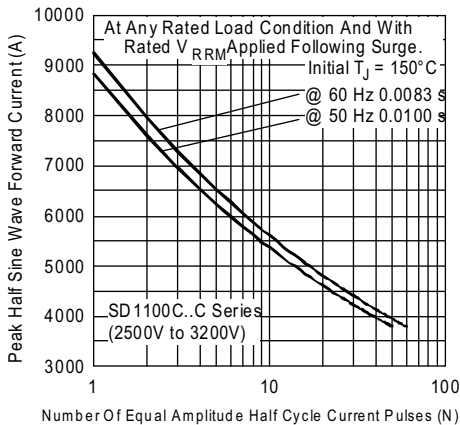

Fig. 15 - Maximum Non-Repetitive Surge Current Single and Double Side Cooled

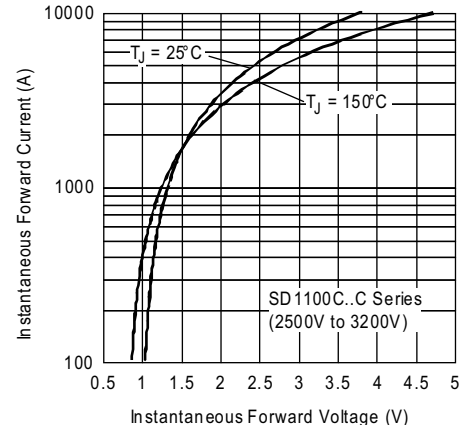

Fig. 18 - Forward Voltage Drop Characteristics



www.vishay.com

VS-SD1100C..C Series

Vishay Semiconductors

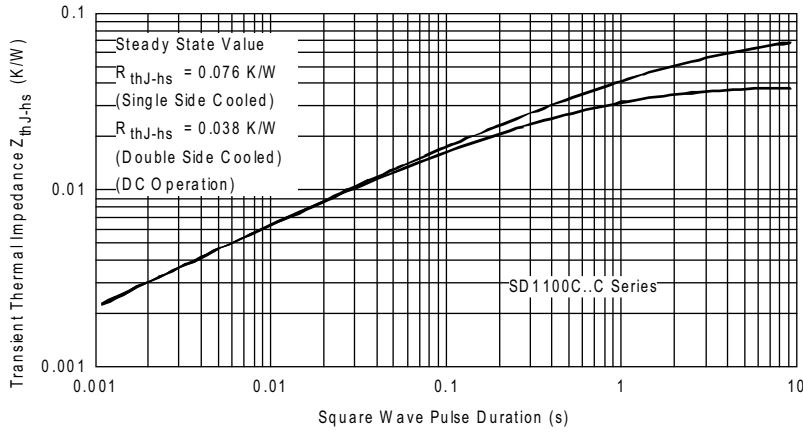

Fig. 19 - Thermal Impedance Z_{thJ-hs} Characteristics

ORDERING INFORMATION TABLE

| | | | | | | | |
|-------------|------------|-----------|------------------------------------------------------------|----------|----------|-----------|----------|
| Device code | VS- | SD | 110 | 0 | C | 32 | C |
| | ① | ② | ③ | ④ | ⑤ | ⑥ | ⑦ |
| | 1 | - | Vishay Semiconductors product | | | | |
| | 2 | - | Diode | | | | |
| | 3 | - | Essential part number | | | | |
| | 4 | - | 0 = Standard recovery | | | | |
| | 5 | - | C = Ceramic PUK | | | | |
| | 6 | - | Voltage code x 100 = V_{RRM} (see Voltage Ratings table) | | | | |
| | 7 | - | C = PUK case B-43 | | | | |

| LINKS TO RELATED DOCUMENTS | |
|----------------------------|------------------------------------------------------------------------|
| Dimensions | www.vishay.com/doc?95249 |



Outline Dimensions

Vishay Semiconductors

B-43

DIMENSIONS in millimeters (inches)

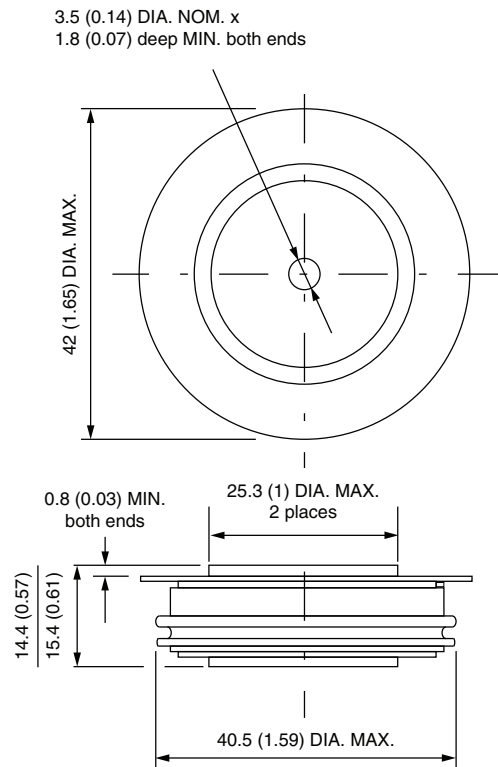

Quote between upper and lower pole pieces has to be considered after application of mounting force (see Thermal and Mechanical Specifications)



Disclaimer

ALL PRODUCT, PRODUCT SPECIFICATIONS AND DATA ARE SUBJECT TO CHANGE WITHOUT NOTICE TO IMPROVE RELIABILITY, FUNCTION OR DESIGN OR OTHERWISE.

Vishay Intertechnology, Inc., its affiliates, agents, and employees, and all persons acting on its or their behalf (collectively, "Vishay"), disclaim any and all liability for any errors, inaccuracies or incompleteness contained in any datasheet or in any other disclosure relating to any product.

Vishay makes no warranty, representation or guarantee regarding the suitability of the products for any particular purpose or the continuing production of any product. To the maximum extent permitted by applicable law, Vishay disclaims (i) any and all liability arising out of the application or use of any product, (ii) any and all liability, including without limitation special, consequential or incidental damages, and (iii) any and all implied warranties, including warranties of fitness for particular purpose, non-infringement and merchantability.

Statements regarding the suitability of products for certain types of applications are based on Vishay's knowledge of typical requirements that are often placed on Vishay products in generic applications. Such statements are not binding statements about the suitability of products for a particular application. It is the customer's responsibility to validate that a particular product with the properties described in the product specification is suitable for use in a particular application. Parameters provided in datasheets and / or specifications may vary in different applications and performance may vary over time. All operating parameters, including typical parameters, must be validated for each customer application by the customer's technical experts. Product specifications do not expand or otherwise modify Vishay's terms and conditions of purchase, including but not limited to the warranty expressed therein.

Except as expressly indicated in writing, Vishay products are not designed for use in medical, life-saving, or life-sustaining applications or for any other application in which the failure of the Vishay product could result in personal injury or death. Customers using or selling Vishay products not expressly indicated for use in such applications do so at their own risk. Please contact authorized Vishay personnel to obtain written terms and conditions regarding products designed for such applications.

No license, express or implied, by estoppel or otherwise, to any intellectual property rights is granted by this document or by any conduct of Vishay. Product names and markings noted herein may be trademarks of their respective owners.