

Excellent Integrated System Limited

Stocking Distributor

Click to view price, real time Inventory, Delivery & Lifecycle Information:

[Molex Connector Corporation](#)
[0751981014](#)

For any questions, you can email us directly:

sales@integrated-circuit.com

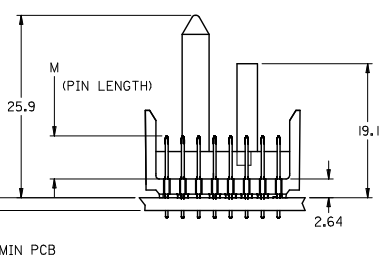
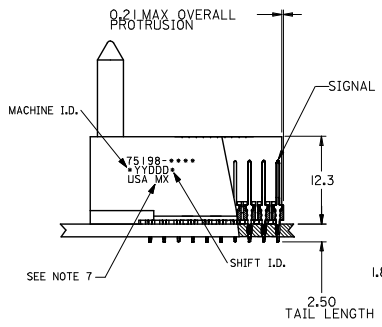
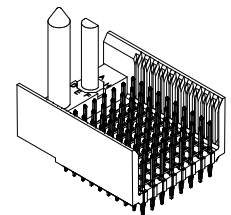
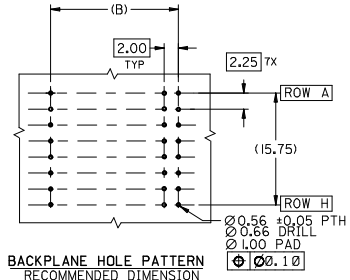
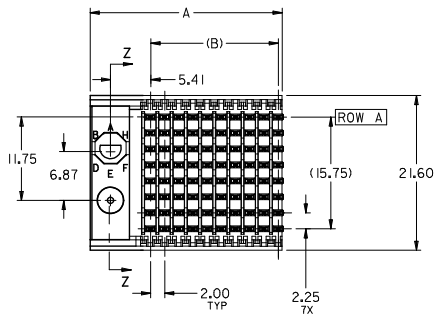

- NOTES:
1. MATERIALS:
HOUSING - LIQUID CRYSTAL POLYMER (LCP),
GLASS-FILLED, UL 94V-0, COLOR: BLACK
SIGNAL PIN - COPPER ALLOY
 2. FINISHES:
CONTACT AREA: SELECTIVE GOLD (Au)
PCB TAILS: SELECTIVE MATTE TIN (Sn)
NICKEL (Ni) OVERALL.
 3. THIS PART CONFORMS TO MOLEX PRODUCT SPECIFICATION PS-74031-999
 4. FOR MIXED CONTACT LENGTHS CONSULT MOLEX FOR AVAILABILITY
 5. FOR SPECIFIC MATERIAL NUMBERS & MATING INFORMATION REFER TO SHEET 2
 6. PACKAGE PER PK-74061-003
 7. MARK PART WITH PART NUMBER & DATE CODE APPROXIMATELY WHERE SHOWN
 8. MAPS (MOLEX ADVANCED PLATING SYSTEM)

THE PRIMARY CARTON WITH A LABEL STATING "ELV AND RoHS COMPLAINT" IS LEAD FREE. CARTONS WITHOUT THIS LABEL MAY CONTAIN LEAD.

LEAD FREE CONVERSION EC NO: LCP2013-0687 DRAWINGS: 2012/08/24 CHK: MOLLER 2012/11/21 APPR: MILLER 2012/12/14	QUALITY SYMBOLS ▽=0 ▽=0 ▽=0	GENERAL TOLERANCES (UNLESS SPECIFIED)		DIMENSION STYLE MM ONLY		SCALE 2.5:1	DESIGN UNITS METRIC	THIRD ANGLE PROJECTION
		mm	INCH	DRAWN BY JMELTON	DATE 2010/05/19	TITLE VHDM LITE 8 ROW SIGNAL END BACKPLANE SALES ASSEMBLY		
G	REV	4 PLACES ±	---	---	CHECKED BY SDANNELLEY	DATE 2010/05/19	molex DOCUMENT NO. SD-75198-001 SHEET NO. 1 OF 2	
		3 PLACES ±	---	---	APPROVED BY MILLER	DATE 2010/07/14		
		2 PLACES ±	---	---	MATERIAL NO.		SEE SHEET 2	
		1 PLACE ±	---	---	SIZE		THIS DRAWING CONTAINS INFORMATION THAT IS PROPRIETARY TO MOLEX INCORPORATED AND SHOULD NOT BE USED WITHOUT WRITTEN PERMISSION	
		0 PLACE ±	---	---	ANGULAR ±1/2°			
		DRAFT WHERE APPLICABLE MUST REMAIN WITHIN DIMENSIONS						

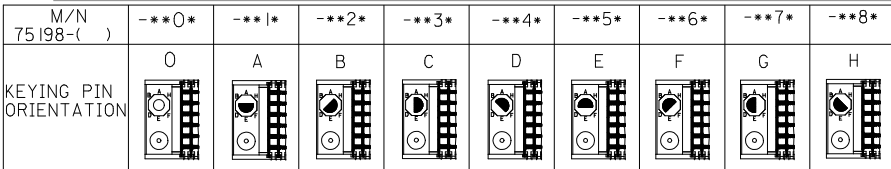

75198 - * * * *

NUMBER OF COLUMNS/PLATING
 10 = 10 COLUMN MATTE TIN (FORMERLY TIN/LEAD)
 25 = 25 COLUMN MATTE TIN (FORMERLY TIN/LEAD)
 60 = 10 COLUMN MATTE TIN (MAPS)
 75 = 25 COLUMN MATTE TIN (MAPS)
 90 = 10 COLUMN MATTE TIN
 85 = 25 COLUMN MATTE TIN

PIN HEIGHT
 1 = 4.75
 2 = 6.25
 3 = 4.25
 4 = 5.15

PART NUMBER	COLUMN	NUMBER OF SIGNAL PIN	NUMBER OF SHIELD	A	B	M	GOLD THICKNESS MICROMETER	TIN THICKNESS MICROMETER
75198-60*1							0.25 MAPS	0.76-152
75198-*0*1	10	80	0	27.00	18.00	4.75	0.76	
75198-75*1							0.25 MAPS	
75198-*5*1	25	200	0	57.00	48.00	4.75	0.76	
75198-60*2							0.25 MAPS	
75198-*0*2	10	80	0	27.00	18.00	6.25	0.76	
75198-75*2							0.25 MAPS	
75198-*5*2	25	200	0	57.00	48.00	6.25	0.76	
75198-60*3							0.25 MAPS	
75198-*0*3	10	80	0	27.00	18.00	4.25	0.76	
75198-75*3							0.25 MAPS	
75198-*5*3	25	200	0	57.00	48.00	4.25	0.76	
75198-60*4							0.25 MAPS	
75198-*0*4	10	80	0	27.00	18.00	5.15	0.76	
75198-75*4							0.25 MAPS	
75198-*5*4	25	200	0	57.00	48.00	5.15	0.76	

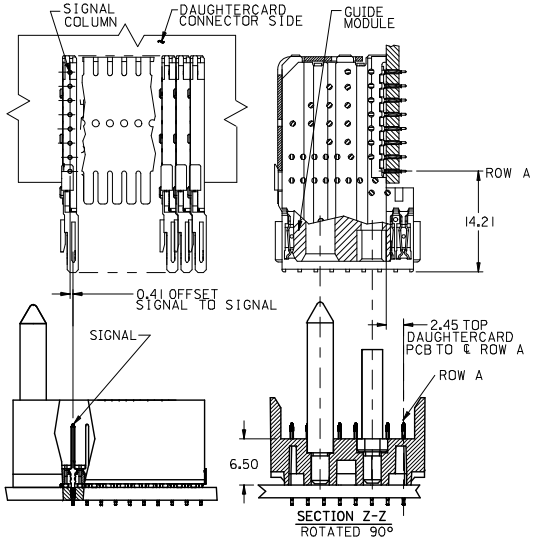

SEE SHEET 1 EC NO: UCP2015-0687 DRAWINGS: 2012/08/24 CHKD: MWLFE 2012/11/21 APPR: SMILLER 2012/12/14 G REV	QUALITY SYMBOLS	GENERAL TOLERANCES (UNLESS SPECIFIED)	DIMENSION STYLE	SCALE	DESIGN UNITS	THIRD ANGLE PROJECTION
	∇=0 ∇=0 ∇=0	mm INCH 4 PLACES ± --- ± --- 3 PLACES ± --- ± --- 2 PLACES ± --- ± --- 1 PLACE ± --- ± --- 0 PLACE ± ±	MM ONLY	2.5:1	METRIC	TITLE: VHDM LITE 8 ROW SIGNAL END BACKPLANE SALES ASSEMBLY MATERIAL NO. SEE TABLE DOCUMENT NO. SD-75198-001
	ANGULAR ±1/2°	DRAFT WHERE APPLICABLE MUST REMAIN WITHIN DIMENSIONS	SIZE C	THIS DRAWING CONTAINS INFORMATION THAT IS PROPRIETARY TO MOLEX INCORPORATED AND SHOULD NOT BE USED WITHOUT WRITTEN PERMISSION		
						SHEET NO. 2 OF 2