



Excellent Integrated System Limited

Stocking Distributor

Click to view price, real time Inventory, Delivery & Lifecycle Information:

[ITT Cannon, LLC](#)
[KPT00A12-8P](#)

For any questions, you can email us directly:

sales@integrated-circuit.com

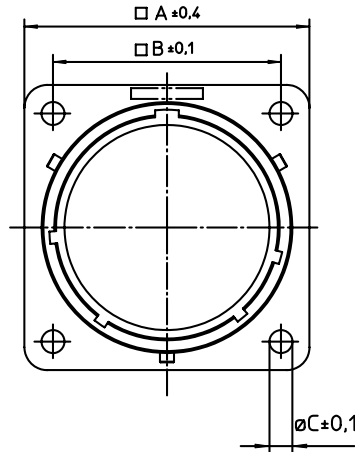
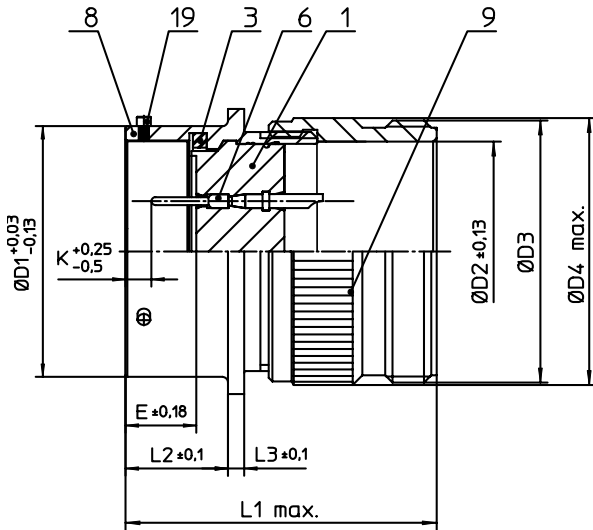

NO.	MASSE / DIMENSIONI
A	26.15
B	20.6
C	3.2
D1	19.05
D2	15.1
D3	3/4-20UNEF-2A
D4	21.2
E	8.25
K	2.16
L1	37
L2	11.6
L3	1.9

NO.	BESCHREIBUNG / DESCRIPTION
1	ISOLIERKÖRPER STIFT / INSULATOR PIN
3	DICHTRING / GASKET
6	KONTAKT STIFT / CONTACT PIN
8	GEHÄUSE / RECEPTACLE
9	ENDGEHÄUSE / ENDBELL
19	BAYONETTSTIFT / BAYONET PIN

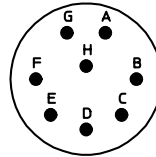

Note: Due to an automatic nomenclature system, numbers generated may not be sequential.
Specification and Dimensions subject to change
Drawings illustrate normal insulator positioning

Material Specification:	
Shell Material:	Aluminium alloy
Shell Plating:	Olive drab chromate over cadmium plating
Insulator Material:	Polychloroprene
Contact Material:	Copper alloy, gold plated
Contact Plating:	Copper alloy, gold plated

all dimensions are in mm
Dimensions without tolerance indications are general tolerances in acc. with DIN7168m

drawing for
CUSTOMER



description KPT00A128P
Wall mounting receptacle
General duty
Solder Cup / Pin / Layout: 12-8

© All rights reserved. Reproduction or issue to third in any form
whenever is only permitted with written authorization of ITT Cannon

page 1/1

revision 1013 5. Jul 16