



Excellent Integrated System Limited

Stocking Distributor

Click to view price, real time Inventory, Delivery & Lifecycle Information:

[ITT Cannon, LLC](#)
[CA3106E10SL-4S14](#)

For any questions, you can email us directly:
sales@integrated-circuit.com

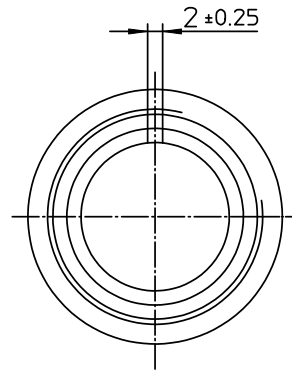
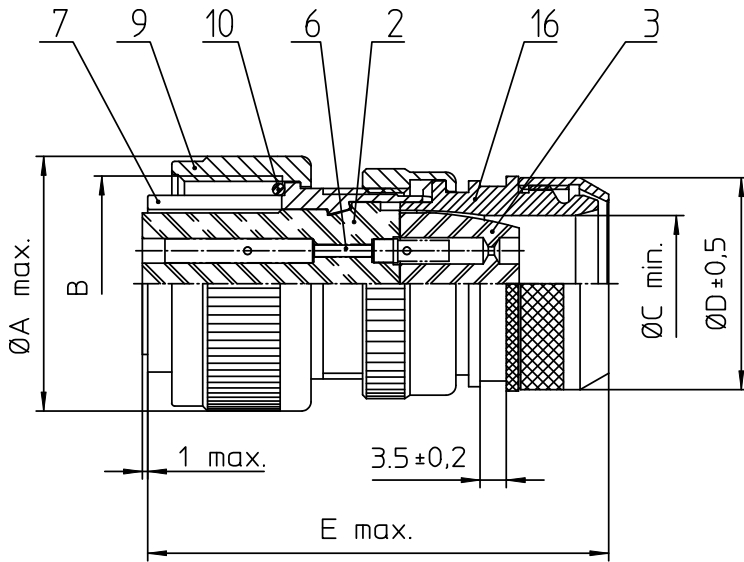

NO.	MASSE / DIMENSION
A	24.1
B	5/8-24NEF-2B
C	7.9
D	-
E	53

NO.	BESCHREIBUNG / DESCRIPTION
2	ISOLIERKÖRPER BUCHSE / INSULATOR SOCKET
3	DICHTKÖRPER / GROMMET
6	KONTAKTBUCHSE / CONTACT SOCKET
7	ZYLINDERGHÄUSE / BARREL
9	ÜBERWURFMUTTER / COUPLING NUT
10	DICHTRING FRONT / FRONT SEALING RING
16	ENDGEHÄUSE GESCHIRMT / ENDBELL SHIELDED

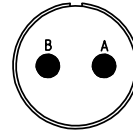

Note: Due to an automatic nomenclature system, numbers generated may not be sequential.
Specification and Dimensions subject to change
Drawings illustrate normal insulator positioning

Material Specification:	
Shell Material:	Aluminium alloy
Shell Plating:	Olive drab chromate coating over cadmium plating
Insulator Material:	Neoprene
Contact Material:	Copper alloy
Contact Plating:	Hard silver

all dimensions are in mm		drawing for	
Dimensions without tolerance indications are general tolerances in acc. with DIN7168m		CUSTOMER	
 ITT Engineered for life ITT CANNON GmbH D-31064 Wunsted, Germany	description	CA3106E10SL-4S-14	
		Plug, straight shielded Endbell with clamp and bushing Metric Crimp / Socket / Layout: 10SL-4	
© All rights reserved. Reproduction or issue in third in any form whatever is only permitted with written authorization of ITT Cannon	page 1/1 revision 377.3, Jul 16		