

Excellent Integrated System Limited

Stocking Distributor

Click to view price, real time Inventory, Delivery & Lifecycle Information:

[Sanken](#)
[2SA1216](#)

For any questions, you can email us directly:

sales@integrated-circuit.com

LAPT

2SA1216

Silicon PNP Epitaxial Planar Transistor (Complement to type 2SC2922)

Application : Audio and General Purpose

■ Absolute maximum ratings (Ta=25°C)

Symbol	Ratings	Unit
V _{CB0}	-180	V
V _{CE0}	-180	V
V _{EB0}	-5	V
I _c	-17	A
I _B	-5	A
P _c	200(T _c =25°C)	W
T _J	150	°C
T _{stg}	-55 to +150	°C

■ Electrical Characteristics (Ta=25°C)

Symbol	Conditions	Ratings	Unit
V _{CB0}	V _{CB} =-180V	-100max	μA
I _{EB0}	V _{EB} =-5V	-100max	μA
V _{(BR)CEO}	I _c =-25mA	-180min	V
h _{FE}	V _{CE} =-4V, I _c =-8A	30min*	
V _{CE(sat)}	I _c =-8A, I _B =-0.8A	-2.0max	V
f _r	V _{CE} =-12V, I _E =2A	40typ	MHz
COB	V _{CB} =-10V, f=1MHz	500typ	pF

*h_{FE} Rank O(30to60), Y(50to100), P(70to140), G(90to180)

External Dimensions MT-200

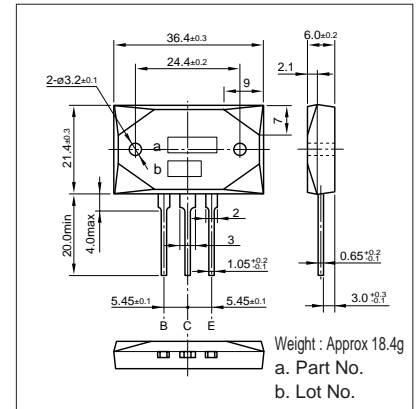

■ Typical Switching Characteristics (Common Emitter)

V _{CC} (V)	R _L (Ω)	I _c (A)	V _{B2} (V)	I _{B1} (A)	I _{B2} (A)	t _{on} (μs)	t _{stg} (μs)	t _f (μs)
-40	4	-10	5	-1	1	0.3typ	0.7typ	0.2typ

I_c-V_{CE} Characteristics (Typical)

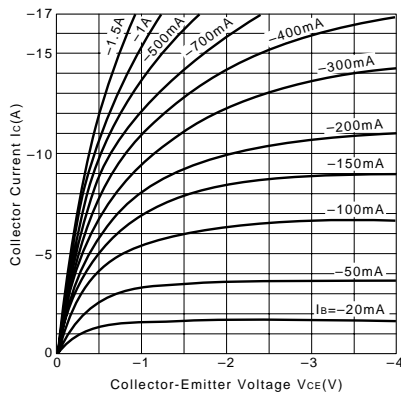

V_{CE(sat)}-I_B Characteristics (Typical)

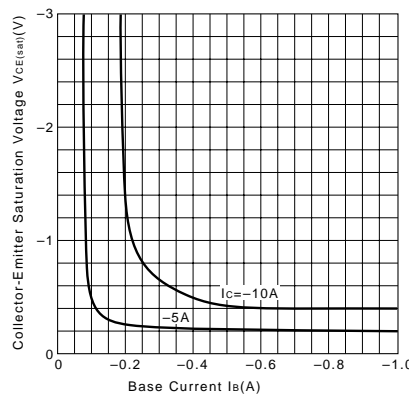

I_c-V_{BE} Temperature Characteristics (Typical)

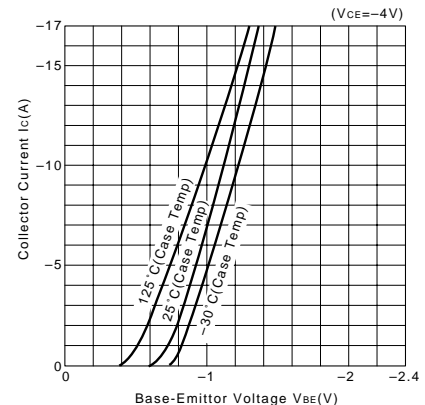

h_{FE}-I_c Characteristics (Typical)

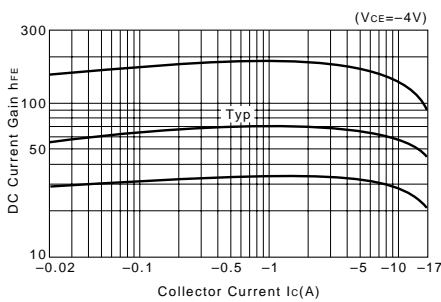

h_{FE}-I_c Temperature Characteristics (Typical)

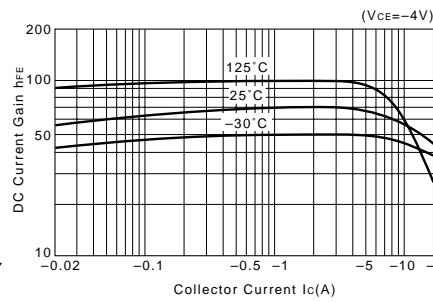

θ_{j-a}-t Characteristics

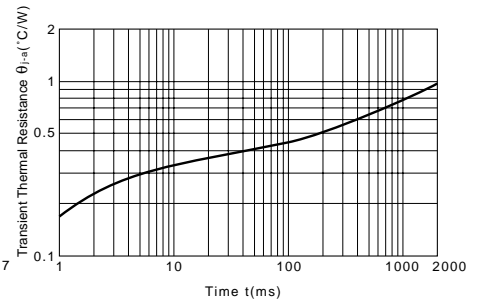

f_r-I_E Characteristics (Typical)

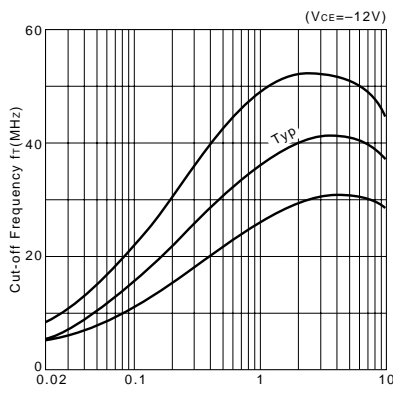

Safe Operating Area (Single Pulse)

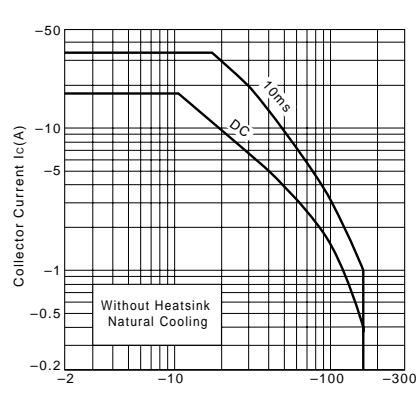

P_c-T_a Derating

