

## **Excellent Integrated System Limited**

Stocking Distributor

Click to view price, real time Inventory, Delivery & Lifecycle Information:

[Sanken](#)  
[2SC2837](#)

For any questions, you can email us directly:

[sales@integrated-circuit.com](mailto:sales@integrated-circuit.com)

LAPT

# 2SC2837

Silicon NPN Epitaxial Planar Transistor (Complement to type 2SA1186)

Application : Audio and General Purpose

■ Absolute maximum ratings (Ta=25°C)

Symbol	Ratings	Unit
V <sub>CB0</sub>	150	V
V <sub>CEO</sub>	150	V
V <sub>EBO</sub>	5	V
I <sub>c</sub>	10	A
I <sub>B</sub>	2	A
P <sub>c</sub>	100(T <sub>c</sub> =25°C)	W
T <sub>j</sub>	150	°C
T <sub>stg</sub>	-55 to +150	°C

■ Electrical Characteristics (Ta=25°C)

Symbol	Conditions	Ratings	Unit
I <sub>CB0</sub>	V <sub>CB</sub> =150V	100max	μA
I <sub>EBO</sub>	V <sub>EB</sub> =5V	100max	μA
V(BR)CEO	I <sub>c</sub> =25mA	150min	V
h <sub>FE</sub>	V <sub>CE</sub> =4V, I <sub>c</sub> =3V	50min*	
V <sub>CE(sat)</sub>	I <sub>c</sub> =5A, I <sub>B</sub> =0.5A	2.0max	V
f <sub>r</sub>	V <sub>CE</sub> =12V, I <sub>E</sub> =-1A	70typ	MHz
COB	V <sub>CB</sub> =80V, f=1MHz	60typ	pF

\*h<sub>FE</sub> Rank O(50 to 100), P(70 to 140), Y(90 to 180)

■ Typical Switching Characteristics (Common Emitter)

V <sub>CC</sub> (V)	R <sub>L</sub> (Ω)	I <sub>c</sub> (A)	V <sub>B2</sub> (V)	I <sub>B1</sub> (mA)	I <sub>B2</sub> (mA)	t <sub>on</sub> (μs)	t <sub>stg</sub> (μs)	t <sub>f</sub> (μs)
60	12	5	-5	500	-500	0.2typ	1.4typ	0.35typ

External Dimensions MT-100(TO3P)

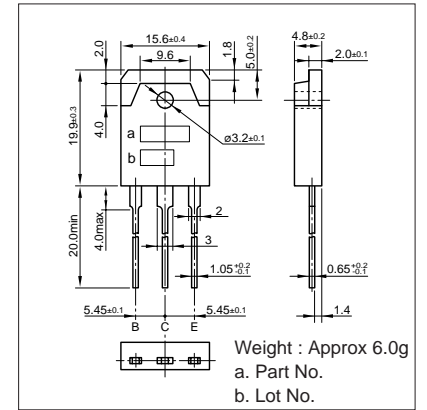

I<sub>c</sub>-V<sub>CE</sub> Characteristics (Typical)

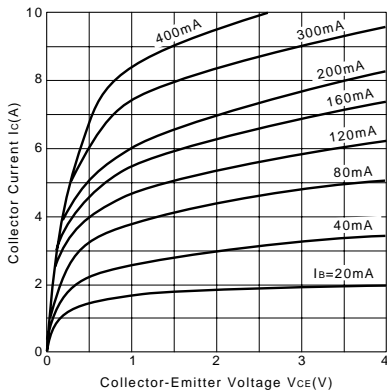

V<sub>CE(sat)</sub>-I<sub>B</sub> Characteristics (Typical)

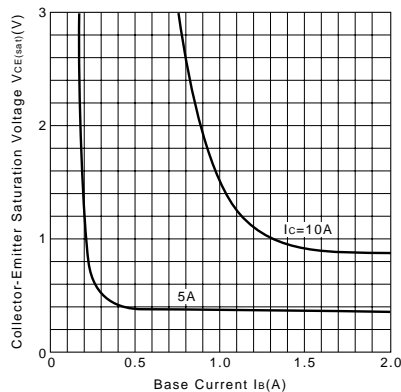

I<sub>c</sub>-V<sub>BE</sub> Temperature Characteristics (Typical)

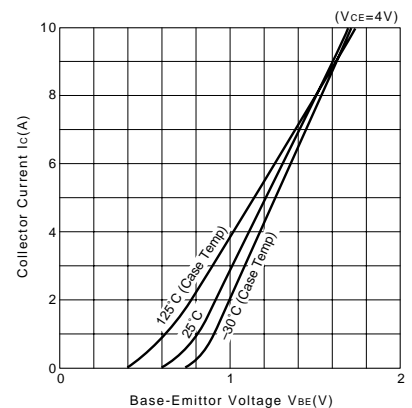

h<sub>FE</sub>-I<sub>c</sub> Characteristics (Typical)

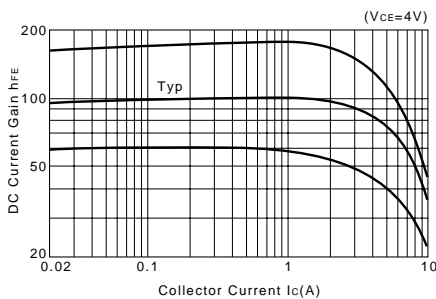

h<sub>FE</sub>-I<sub>c</sub> Temperature Characteristics (Typical)

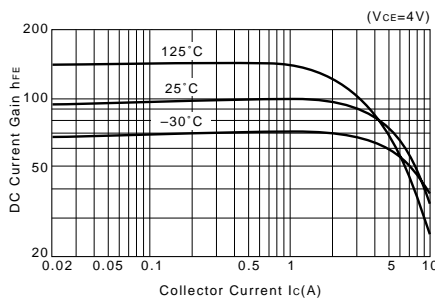

θ<sub>j-a</sub>-t Characteristics

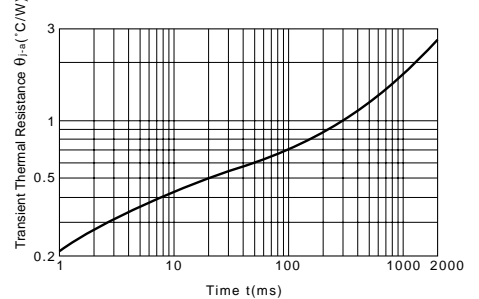

f<sub>r</sub>-I<sub>c</sub> Characteristics (Typical)

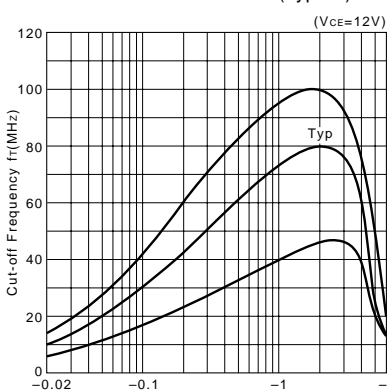

Safe Operating Area (Single Pulse)

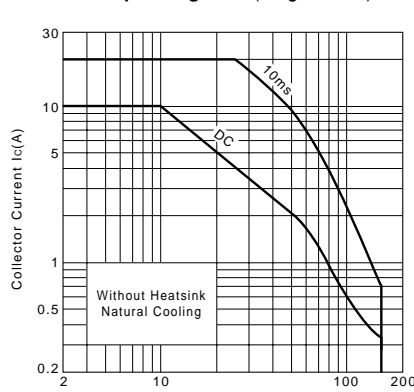

P<sub>c</sub>-T<sub>a</sub> Derating

