

Excellent Integrated System Limited

Stocking Distributor

Click to view price, real time Inventory, Delivery & Lifecycle Information:

[Sanken](#)
[2SC5071](#)

For any questions, you can email us directly:

sales@integrated-circuit.com

2SC5071

Silicon NPN Triple Diffused Planar Transistor (High Voltage and High Speed Switching Transistor) Application : Switching Regulator and General Purpose

■ Absolute maximum ratings (Ta=25°C)

Symbol	Ratings	Unit
V _{CB0}	500	V
V _{CE0}	400	V
V _{EB0}	10	V
I _C	12(Pulse24)	A
I _B	4	A
P _C	100(T _C =25°C)	W
T _J	150	°C
T _{stg}	-55 to +150	°C

■ Electrical Characteristics (Ta=25°C)

Symbol	Conditions	Ratings	Unit
I _{CB0}	V _{CB} =500V	100max	μA
I _{EB0}	V _{EB} =10V	100max	μA
V _{(BR)CEO}	I _C =25mA	400min	V
h _{FE}	V _{CE} =4V, I _C =7A	10 to 30	
V _{CE(sat)}	I _C =7A, I _B =1.4A	0.5max	V
V _{BE(sat)}	I _C =7A, I _B =1.4A	1.3max	V
f _r	V _{CE} =12V, I _E =-1A	10typ	MHz
COB	V _{CB} =10V, f=1MHz	105typ	pF

External Dimensions MT-100(TO3P)

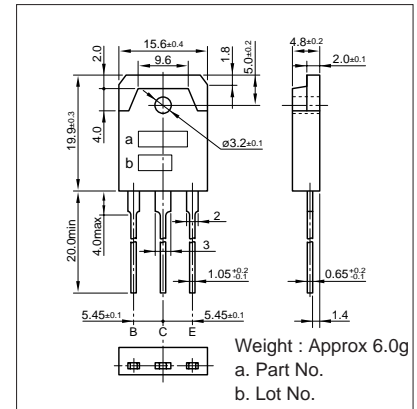

■ Typical Switching Characteristics (Common Emitter)

V _{CC} (V)	R _L (Ω)	I _C (A)	V _{BB1} (V)	V _{BB2} (V)	I _{B1} (A)	I _{B2} (A)	t _{on} (μs)	t _{stg} (μs)	t _f (μs)
200	28.5	7	10	-5	0.7	-1.4	1.0max	3.0max	0.5max

I_C-V_{CE} Characteristics (Typical)

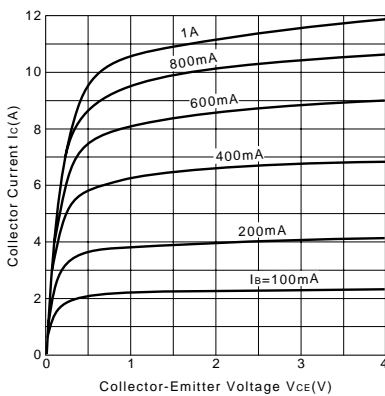

V_{CE(sat)}, V_{BE(sat)}-I_C Temperature Characteristics (Typical)

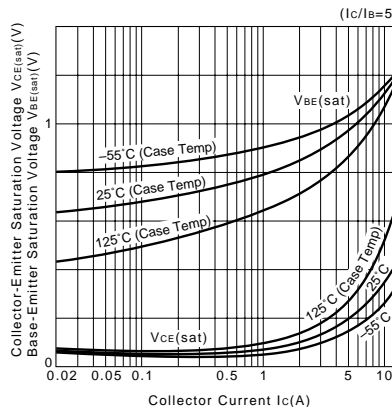

I_C-V_{BE} Temperature Characteristics (Typical)

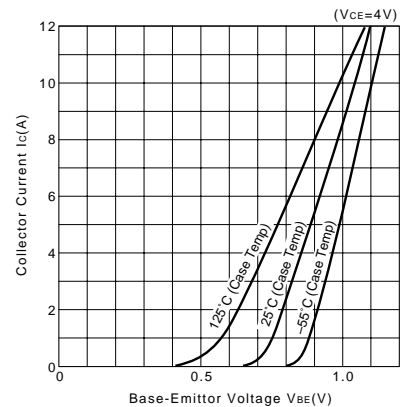

h_{FE}-I_C Characteristics (Typical)

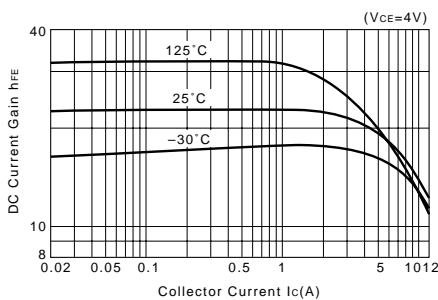

t_{on}, t_{stg}, t_f-I_C Characteristics (Typical)

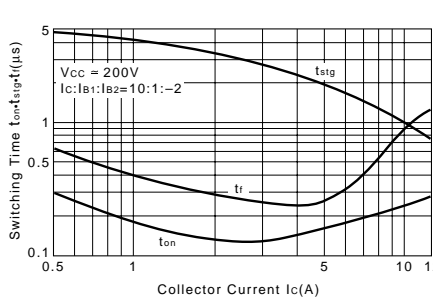

θ_{j-a}-t Characteristics

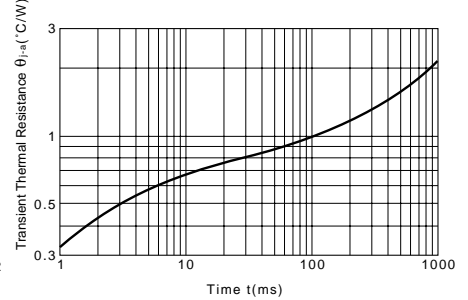

Safe Operating Area (Single Pulse)

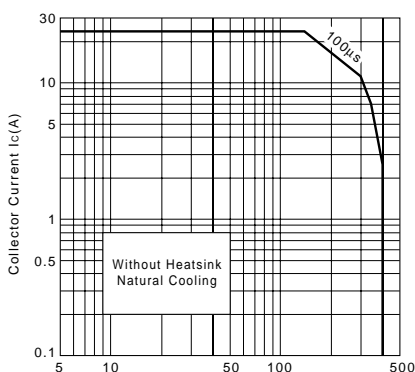

Reverse Bias Safe Operating Area

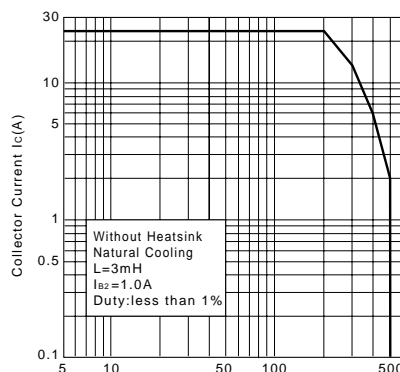

P_C-T_a Derating

