

## Excellent Integrated System Limited

Stocking Distributor

Click to view price, real time Inventory, Delivery & Lifecycle Information:

[STMicroelectronics](#)  
[ESDALC6-4N4](#)

For any questions, you can email us directly:

[sales@integrated-circuit.com](mailto:sales@integrated-circuit.com)



# ESDALC6-4N4

## ESD array with low capacitance

Datasheet – production data

### Features

- Stand-off voltage 7 V
- Very low capacitance: 9.5 pF
- Small package: 1.0 x 0.8 mm
- Very thin package: 0.40 mm max
- Low leakage current: 70 nA at 25 °C

### Benefits

- High ESD protection level
- High integration
- suitable for high speed interface

### Complies with the following standards

- IEC 61000-4-2:
  - 15 kV (air discharge)
  - 8 kV (contact discharge)
- MIL STD 883G- Method 3015-7: class3B:
  - >25 kV (human body model)

### Applications

Where transient overvoltage protection and electrical overstress protection in sensitive equipment is required, such as:

- Communication systems
- Cellular phone handsets and accessories
- Video equipment
- Portable equipment

### Description

The ESDALC6-4N4 is monolithic array designed to protect up to 4 lines against ESD transients. It has been designed specifically for the protection of the high speed interface of integrated circuits in portable equipment and miniaturized electronics devices. The  $\mu$ QFN-4L package minimizes PCB space.

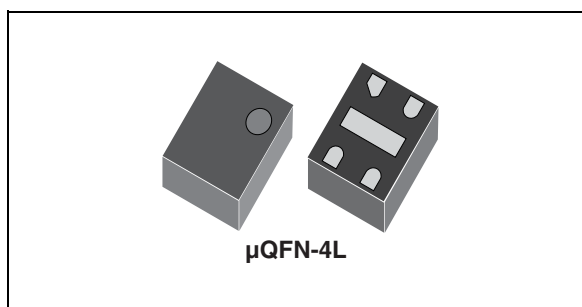
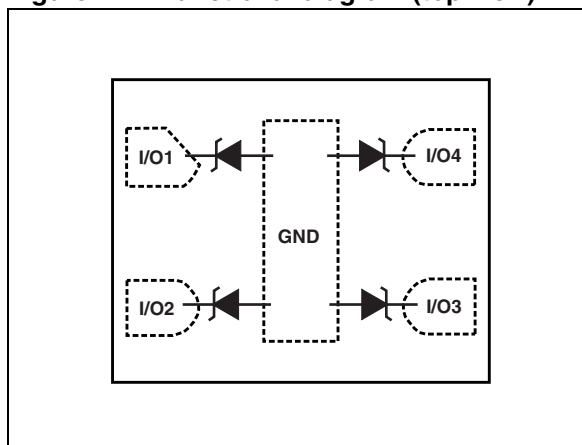


Figure 1. Functional diagram (top view)



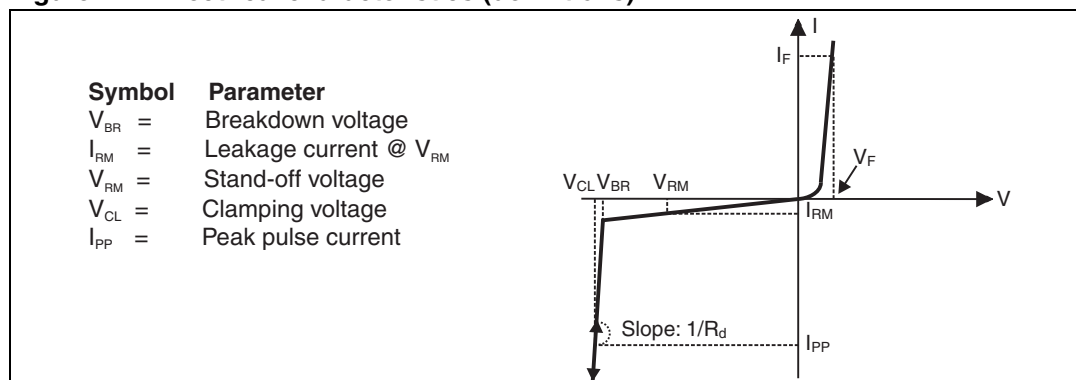
# 1 Characteristics

**Table 1. Absolute maximum ratings ( $T_{amb} = 25\text{ }^{\circ}\text{C}$ )**

Symbol	Parameter	Value	Unit	
$V_{PP}$	ESD IEC 61000-4-2, level 4 (contact discharge)	11	kV	
$P_{PP}$	Peak pulse power dissipation (8/20 $\mu\text{s}$ ) <sup>(1)</sup>	$T_j$ initial = $T_{amb}$	27	W
$I_{pp}$	Repetitive peak pulse current typical value (8/20 $\mu\text{s}$ )	2.3	A	
$T_j$	Maximum junction temperature	125	$^{\circ}\text{C}$	
$T_{stg}$	Storage temperature range	-55 + 150	$^{\circ}\text{C}$	

1. For a surge greater than the maximum values, the diode will fail in short-circuit.

**Figure 2. Electrical characteristics (definitions)**



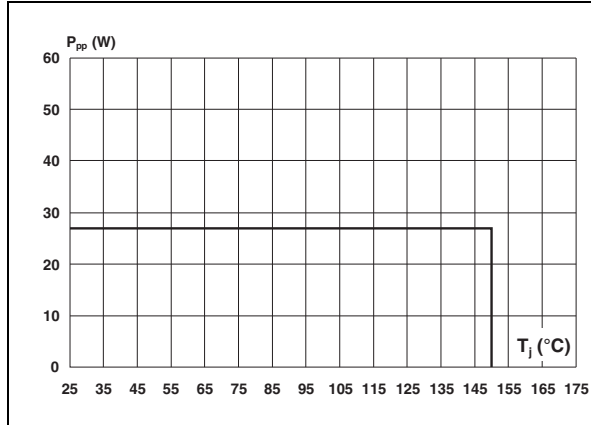
**Table 2. Electrical characteristics (values,  $T_{amb} = 25\text{ }^{\circ}\text{C}$ )**

Symbol	Test conditions	Min.	Typ.	Max.	Unit
$V_{BR}$	$I_R = 1\text{ mA}$	6			V
$I_{RM}$	$V_{RM} = 3\text{ V}$			70	nA
$V_{CL}$	$I_{pp} = 1\text{ A}$ , 8/20 $\mu\text{s}$			10	V
C	$V_R = 0\text{ V}$ , $F = 1\text{ MHz}$ , $V_{osc} = 30\text{ mV}$		9.5	11	pF

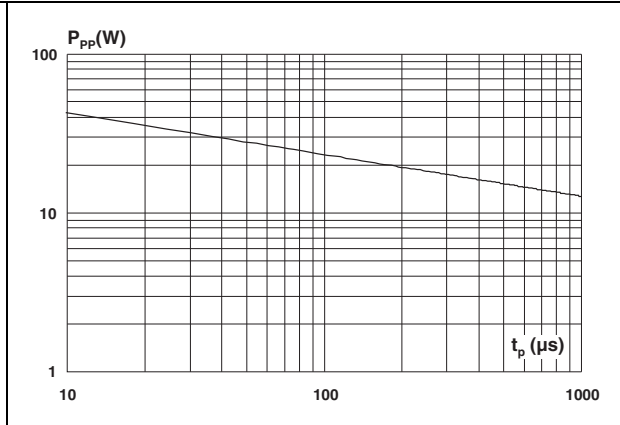
**ESDALC6-4N4**

**Characteristics**

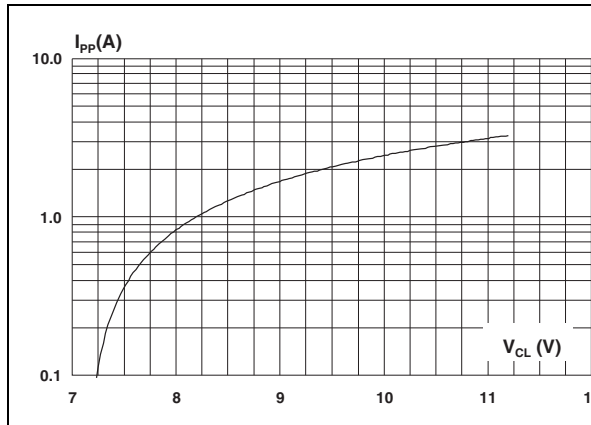
**Figure 3. Peak pulse power versus initial junction temperature (typical values, 8/20  $\mu$ s waveform)**



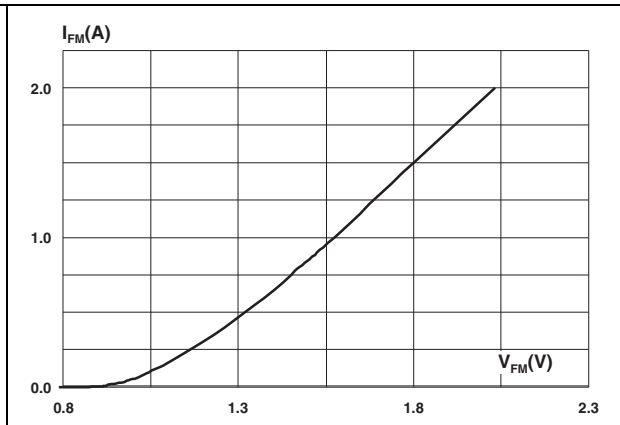
**Figure 4. Peak pulse power versus exponential pulse duration (typical values)**



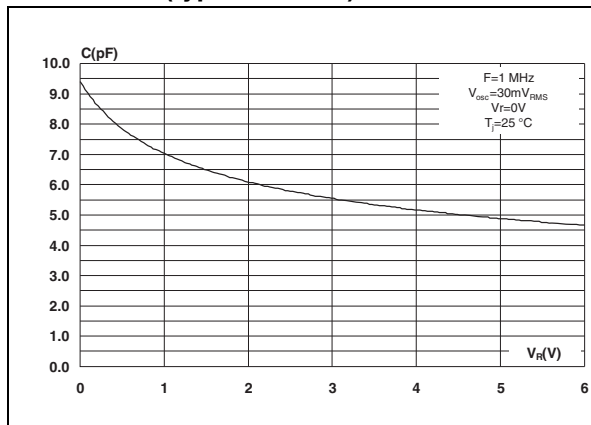
**Figure 5. Clamping voltage versus peak pulse current (typical values, 8/20  $\mu$ s waveform)**



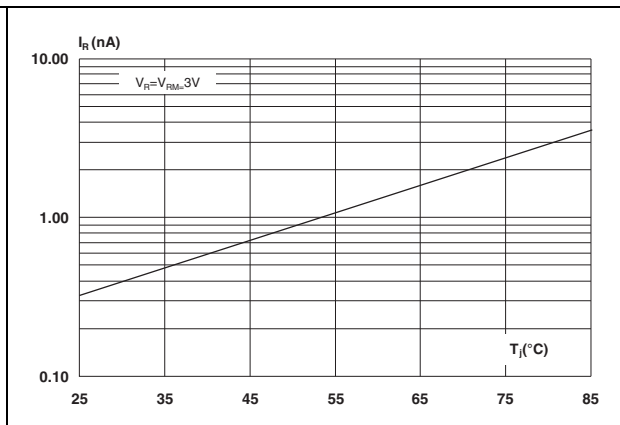
**Figure 6. Forward voltage drop versus peak forward current (typical values)**



**Figure 7. Junction capacitance versus reverse voltage applied (typical values)**



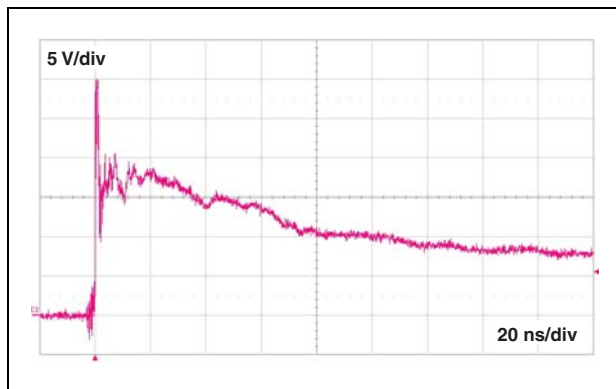
**Figure 8. Leakage current versus junction temperature (typical values)**



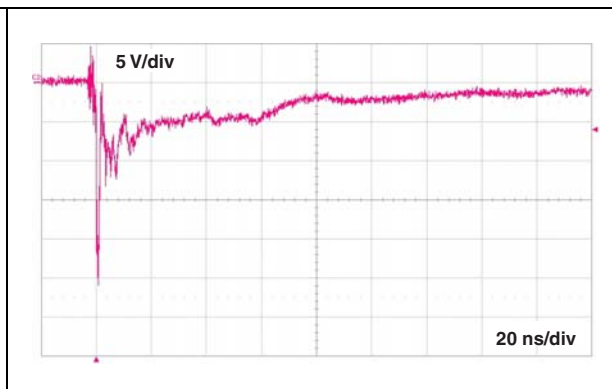
**Characteristics**

**ESDALC6-4N4**

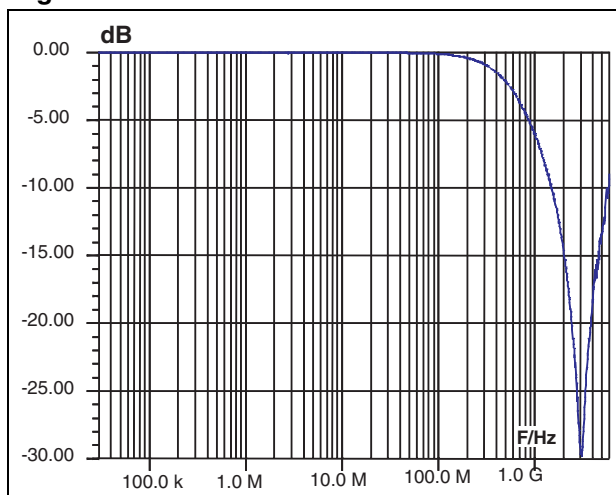
**Figure 9. ESD response to IEC 6100-4-2 (+8 kV contact discharge) on each channel**



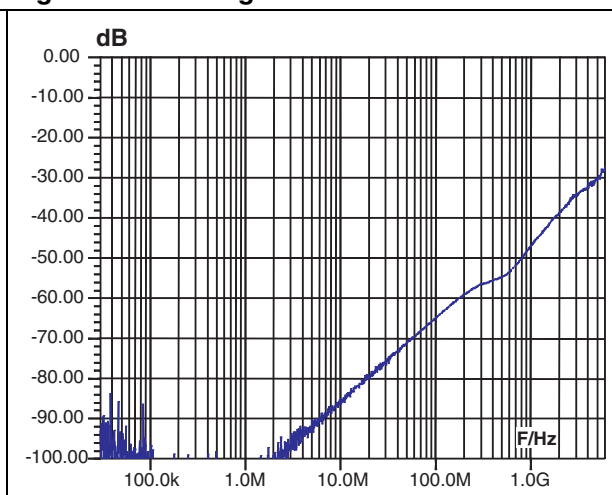
**Figure 10. ESD response to IEC 6100-4-2 (-8 kV contact discharge) on each channel**



**Figure 11. S21 attenuation measurement**

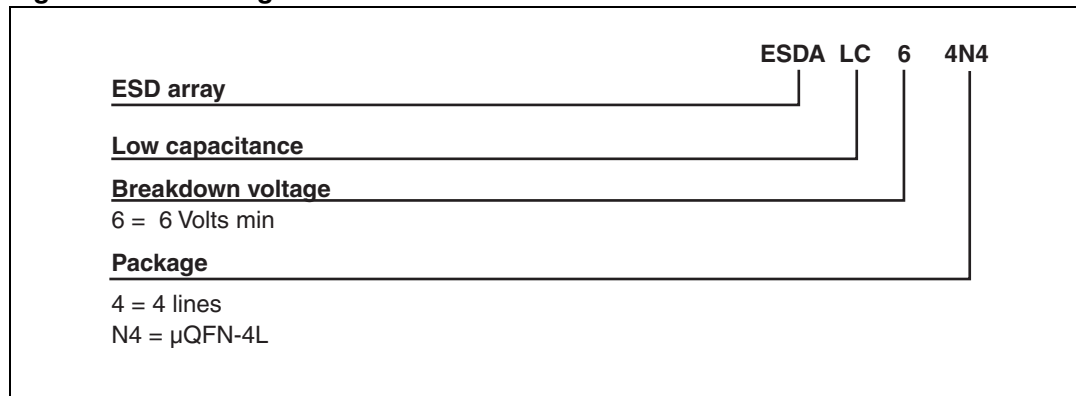


**Figure 12. Analog crosstalk measurement**



## 2 Ordering information scheme

Figure 13. Ordering information scheme



### 3 Package information

- Epoxy meets UL94, V0
- Lead-free package

In order to meet environmental requirements, ST offers these devices in different grades of ECOPACK® packages, depending on their level of environmental compliance. ECOPACK® specifications, grade definitions and product status are available at: [www.st.com](http://www.st.com). ECOPACK® is an ST trademark.

Table 3. μQFN-4L dimensions

Ref.	Dimensions					
	Millimeters			Inches		
	Min.	Typ.	Max.	Min.	Typ.	Max.
A	0.31	0.38	0.40	0.012	0.015	0.016
A1	0.00	0.02	0.05	0.00	0.0008	0.002
b	0.10	0.15	0.20	0.004	0.006	0.008
D	0.70	0.80	0.90	0.028	0.031	0.035
D2	0.50	0.58	0.65	0.020	0.023	0.026
e	0.35	0.40	0.45	0.014	0.016	0.018
E	0.90	1.00	1.10	0.035	0.039	0.043
E2	0.15	0.20	0.25	0.006	0.008	0.010
L	0.18	0.23	0.28	0.007	0.009	0.011
L1	0.00	--	0.05	0.00	--	0.002

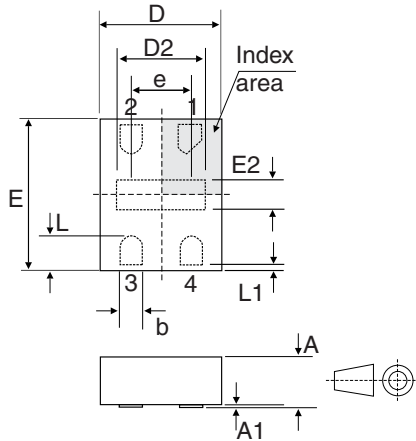
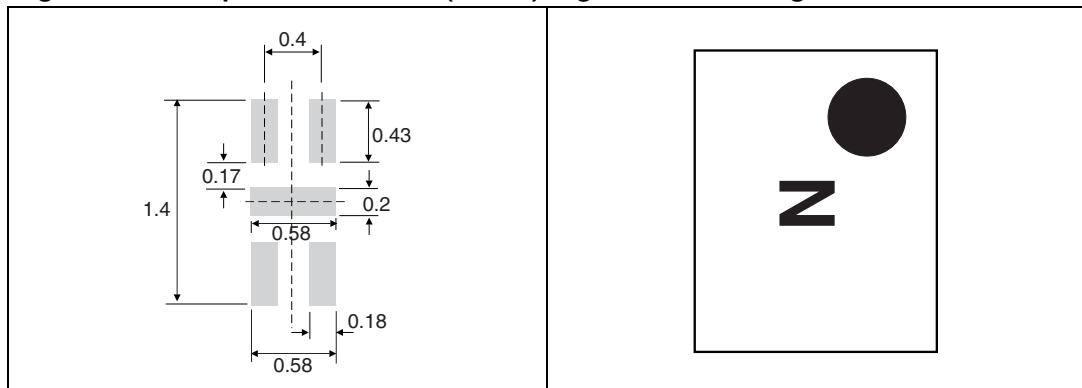


Figure 14. Footprint dimensions (in mm) Figure 15. Marking

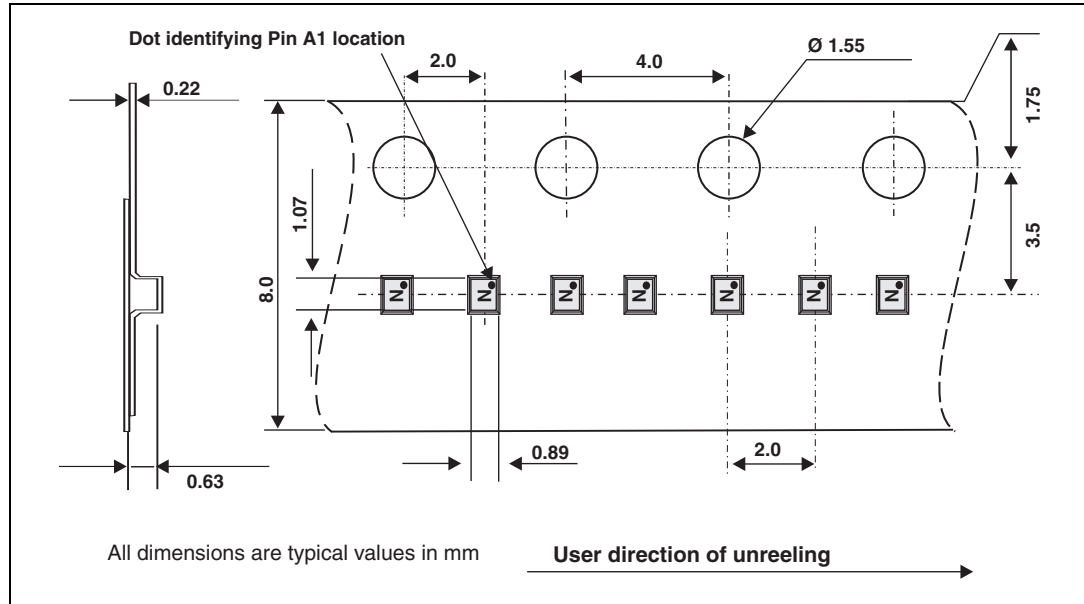


Note: Product marking may be rotated by multiples of 90° for assembly plant differentiation. In no case should this product marking be used to orient the component for its placement on a PCB. Only pin 1 mark is to be used for this purpose.

**ESDALC6-4N4**

**Package information**

**Figure 16. Tape and reel specifications**





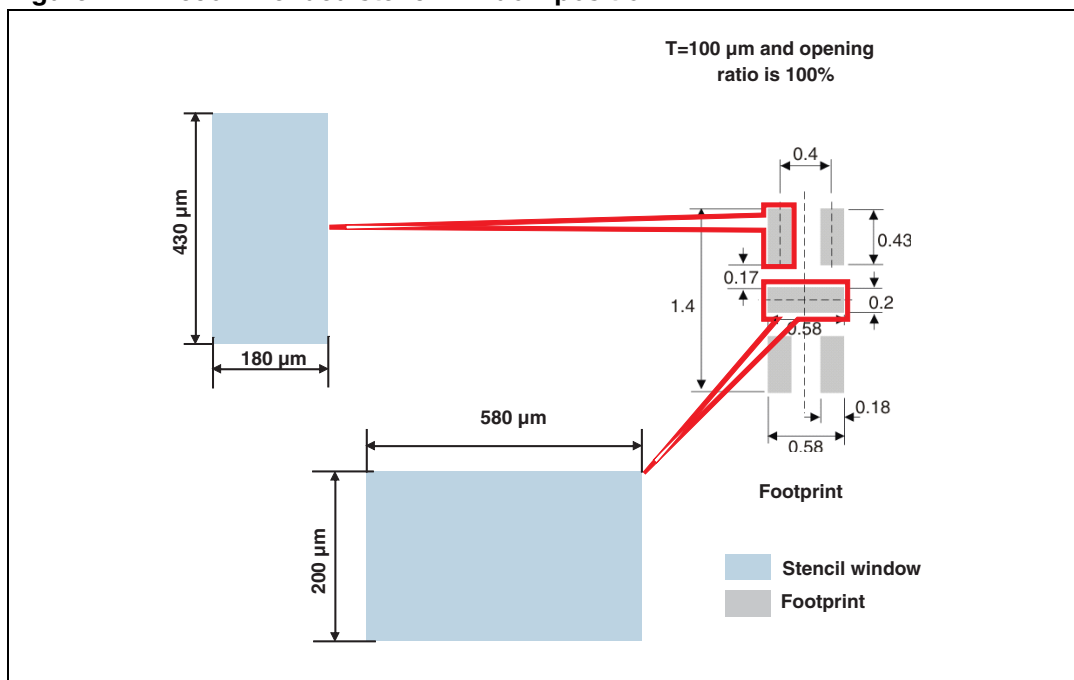
## 4 Recommendation on PCB assembly

### 4.1 Stencil opening design

Reference design

- Stencil opening thickness: 100  $\mu\text{m}$
- Stencil opening for leads: Opening to footprint ratio is 100%.

**Figure 17. Recommended stencil window position**



### 4.2 Solder paste

1. Halide-free flux qualification ROL0 according to ANSI/J-STD-004.
2. "No clean" solder paste is recommended.
3. Offers a high tack force to resist component movement during high speed.
4. Solder paste with fine particles: powder particle size is 20-45  $\mu\text{m}$ .

### 4.3 Placement

1. Manual positioning is not recommended.
2. It is recommended to use the lead recognition capabilities of the placement system, not the outline centering.
3. Standard tolerance of  $\pm 0.05 \text{ mm}$  is recommended.

**ESDALC6-4N4**

**Recommendation on PCB assembly**

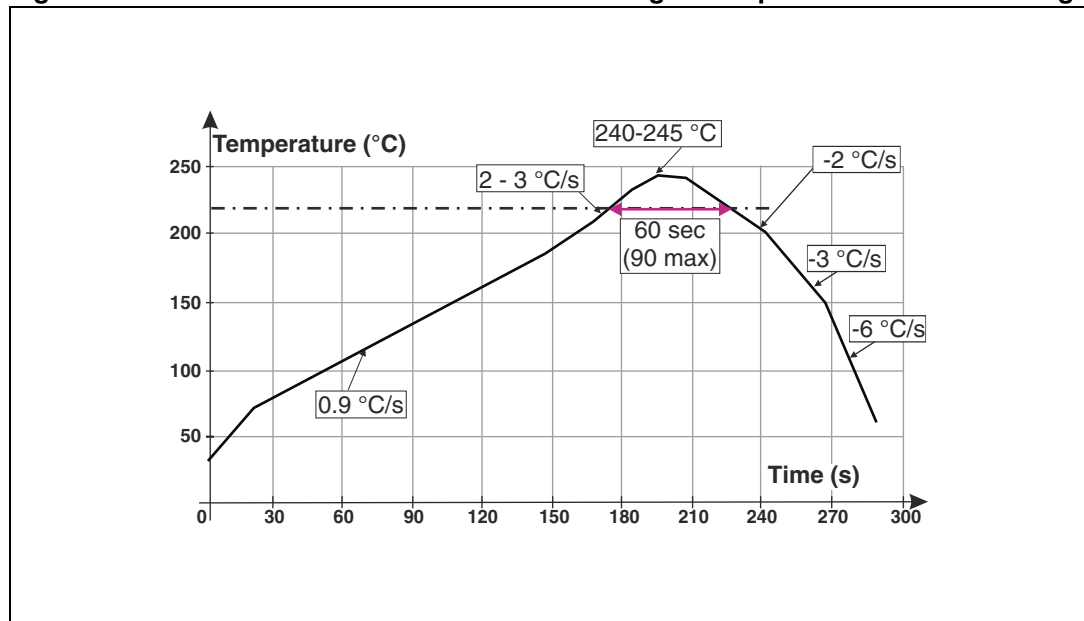
4. 3.5 N placement force is recommended. Too much placement force can lead to squeezed out solder paste and cause solder joints to short. Too low placement force can lead to insufficient contact between package and solder paste that could cause open solder joints or badly centered packages.
5. To improve the package placement accuracy, a bottom side optical control should be performed with a high resolution tool.
6. For assembly, a perfect supporting of the PCB (all the more on flexible PCB) is recommended during solder paste printing, pick and place and reflow soldering by using optimized tools.

**4.4 PCB design preference**

1. To control the solder paste amount, the closed via is recommended instead of open vias.
2. The position of tracks and open vias in the solder area should be well balanced. The symmetrical layout is recommended, in case any tilt phenomena caused by asymmetrical solder paste amount due to the solder flow away.

**4.5 Reflow profile**

**Figure 18. ST ECOPACK® recommended soldering reflow profile for PCB mounting**



*Note: Minimize air convection currents in the reflow oven to avoid component movement.*

## 5 Ordering information

Table 4. Ordering information

Order code	Marking	Package	Weight	Base qty	Delivery mode
ESDALC6-4N4	N <sup>(1)</sup>	μQFN-4L	1.17 mg	10000	Tape and reel

1. The marking can be rotated by multiples of 90° to differentiate assembly location

## 6 Revision history

Table 5. Document revision history

Date	Revision	Changes
06-Sep-2011	1	Initial release.
25-Sep-2012	2	Updated ECOPACK statement.

## ESDALC6-4N4

---

### Please Read Carefully:

Information in this document is provided solely in connection with ST products. STMicroelectronics NV and its subsidiaries ("ST") reserve the right to make changes, corrections, modifications or improvements, to this document, and the products and services described herein at any time, without notice.

All ST products are sold pursuant to ST's terms and conditions of sale.

Purchasers are solely responsible for the choice, selection and use of the ST products and services described herein, and ST assumes no liability whatsoever relating to the choice, selection or use of the ST products and services described herein.

No license, express or implied, by estoppel or otherwise, to any intellectual property rights is granted under this document. If any part of this document refers to any third party products or services it shall not be deemed a license grant by ST for the use of such third party products or services, or any intellectual property contained therein or considered as a warranty covering the use in any manner whatsoever of such third party products or services or any intellectual property contained therein.

**UNLESS OTHERWISE SET FORTH IN ST'S TERMS AND CONDITIONS OF SALE ST DISCLAIMS ANY EXPRESS OR IMPLIED WARRANTY WITH RESPECT TO THE USE AND/OR SALE OF ST PRODUCTS INCLUDING WITHOUT LIMITATION IMPLIED WARRANTIES OF MERCHANTABILITY, FITNESS FOR A PARTICULAR PURPOSE (AND THEIR EQUIVALENTS UNDER THE LAWS OF ANY JURISDICTION), OR INFRINGEMENT OF ANY PATENT, COPYRIGHT OR OTHER INTELLECTUAL PROPERTY RIGHT.**

**UNLESS EXPRESSLY APPROVED IN WRITING BY TWO AUTHORIZED ST REPRESENTATIVES, ST PRODUCTS ARE NOT RECOMMENDED, AUTHORIZED OR WARRANTED FOR USE IN MILITARY, AIR CRAFT, SPACE, LIFE SAVING, OR LIFE SUSTAINING APPLICATIONS, NOR IN PRODUCTS OR SYSTEMS WHERE FAILURE OR MALFUNCTION MAY RESULT IN PERSONAL INJURY, DEATH, OR SEVERE PROPERTY OR ENVIRONMENTAL DAMAGE. ST PRODUCTS WHICH ARE NOT SPECIFIED AS "AUTOMOTIVE GRADE" MAY ONLY BE USED IN AUTOMOTIVE APPLICATIONS AT USER'S OWN RISK.**

Resale of ST products with provisions different from the statements and/or technical features set forth in this document shall immediately void any warranty granted by ST for the ST product or service described herein and shall not create or extend in any manner whatsoever, any liability of ST.

ST and the ST logo are trademarks or registered trademarks of ST in various countries.

Information in this document supersedes and replaces all information previously supplied.

The ST logo is a registered trademark of STMicroelectronics. All other names are the property of their respective owners.

© 2012 STMicroelectronics - All rights reserved

STMicroelectronics group of companies

Australia - Belgium - Brazil - Canada - China - Czech Republic - Finland - France - Germany - Hong Kong - India - Israel - Italy - Japan - Malaysia - Malta - Morocco - Philippines - Singapore - Spain - Sweden - Switzerland - United Kingdom - United States of America

[www.st.com](http://www.st.com)