

## Excellent Integrated System Limited

Stocking Distributor

Click to view price, real time Inventory, Delivery & Lifecycle Information:

[CUI Inc.](#)  
[SJ-43502PM](#)

For any questions, you can email us directly:

[sales@integrated-circuit.com](mailto:sales@integrated-circuit.com)

REV.	DESCRIPTION	DATE
A	NEW DRAWING	11/9/2005
B	Added pin tolerances	8/31/2006
C	added hole dimensions for output terminals	6/2/2008
D	material list update	8/7/2008

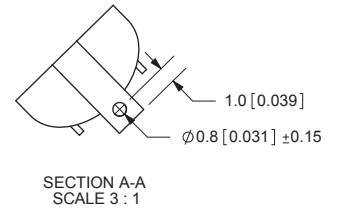
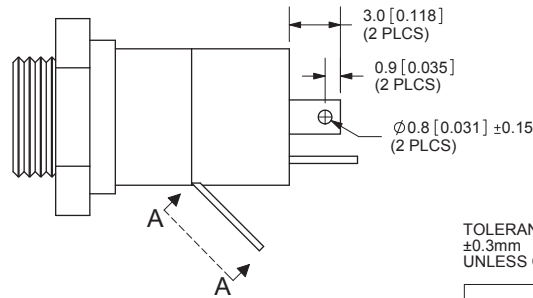
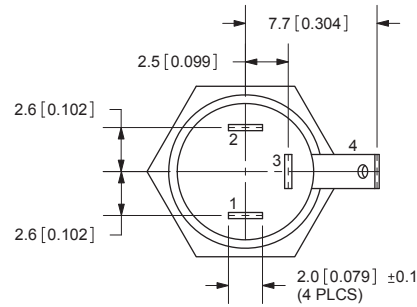
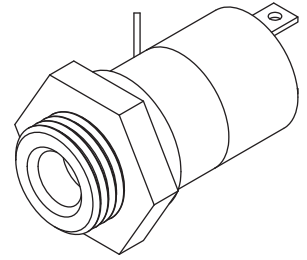
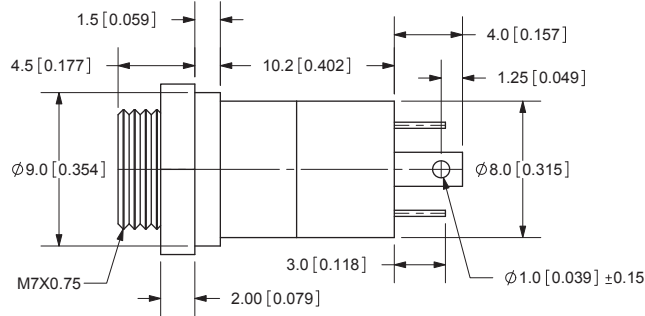
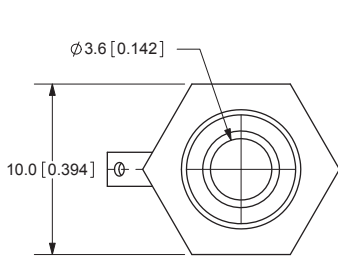

TOLERANCE:  
±0.3mm  
UNLESS OTHERWISE SPECIFIED

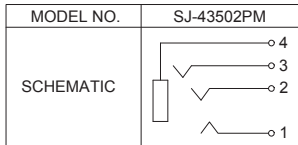

**SPECIFICATIONS:**

RATING: 34V DC or 34V AC @ 1A  
 CONTACT RESISTANCE: 50m OHMS MAX  
 INSULATION RESISTANCE: 100M OHMS MIN: 500V DC  
 VOLTAGE WITHSTAND: 500V AC R.M.S. FOR 1 MINUTE  
 LIFE: 5,000 CYCLES  
 OPERATING TEMP: -20 to 70C

	MATERIAL	PLATING
HEX NUT	Steel	Nickel
TERMINAL 1	Copper Alloy	Gold
TERMINAL 2	Copper Alloy	Nickel
TERMINAL 3	Copper Alloy	Nickel
TERMINAL 4	Brass	Nickel
HOUSING	PBT	



20050 SW 112th Ave.  
 Tualatin, OR 97062  
 Phone: 503-612-2300  
 800-275-4899  
 Fax: 503-612-2383  
 Website: www.cui.com

TITLE:	3.5mm Panel Mount Audio Jack - 4 Connector	REV:	D
PART NO.	SJ-43502PM	UNITS:	MM [INCHES]
DRAWN BY:	ZRJ	APPROVED BY:	
		SCALE:	3:1

PC FILE NAME:  
SJ-43502PM

COPYRIGHT 2008 BY CUI INC.