

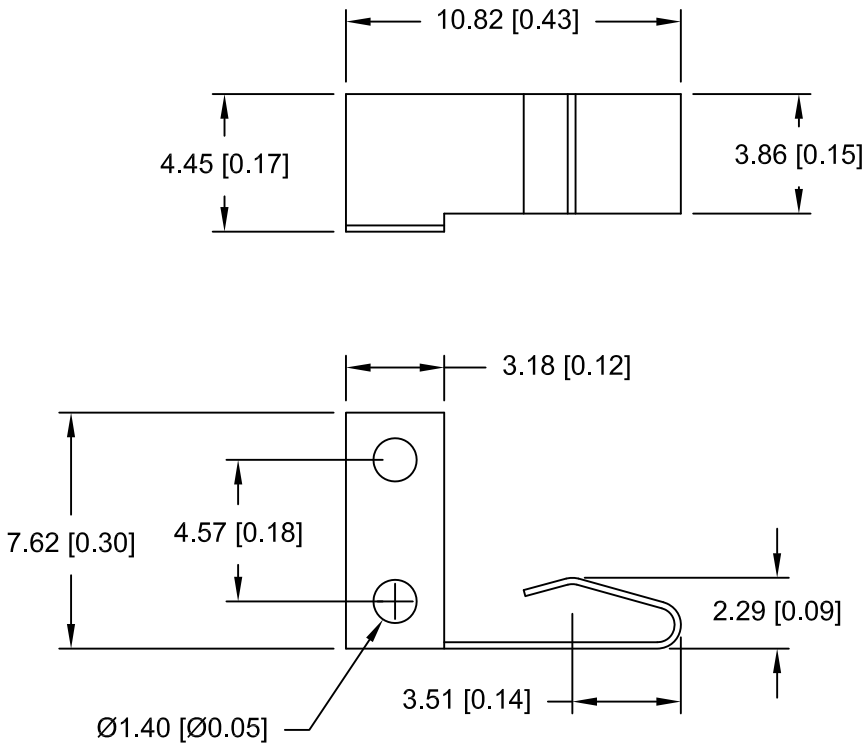

Date	SYM	REVISION RECORD	AUTH	DR.	CK.
8/06/10	A	UPDATED MATERIAL NOTES	T.B.	B.S.	
12/05/14	B	UPDATED TO ROHS 2 COMPLIANT	T.B.	B.S.	



NOTE:
 .008" THICK ANNEALED SPRING STEEL
 HEAT TREAT TO SPRING TEMPER
 GOLD FLASH OVERALL
 ROHS 2 COMPLIANT

Tolerance (Except as noted)	 Memory Protection Devices, Inc 200 Broad Hollow Road, Farmingdale, New York 11735		
decimal ±.020 (.5)		Scale	Drawn By B.S.
Fractional ± .030 (.8)	Title AAAA BATTERY CONTACT, SURFACE MOUNT, OFF BOARD		
Angular ± 3°	Date 12/05/14	Drawing Number BK-6112	
		Approved By T.B.	