

Excellent Integrated System Limited

Stocking Distributor

Click to view price, real time Inventory, Delivery & Lifecycle Information:

[Taoglas Limited](#)
[AP.12F.07.0045A](#)

For any questions, you can email us directly:
sales@integrated-circuit.com

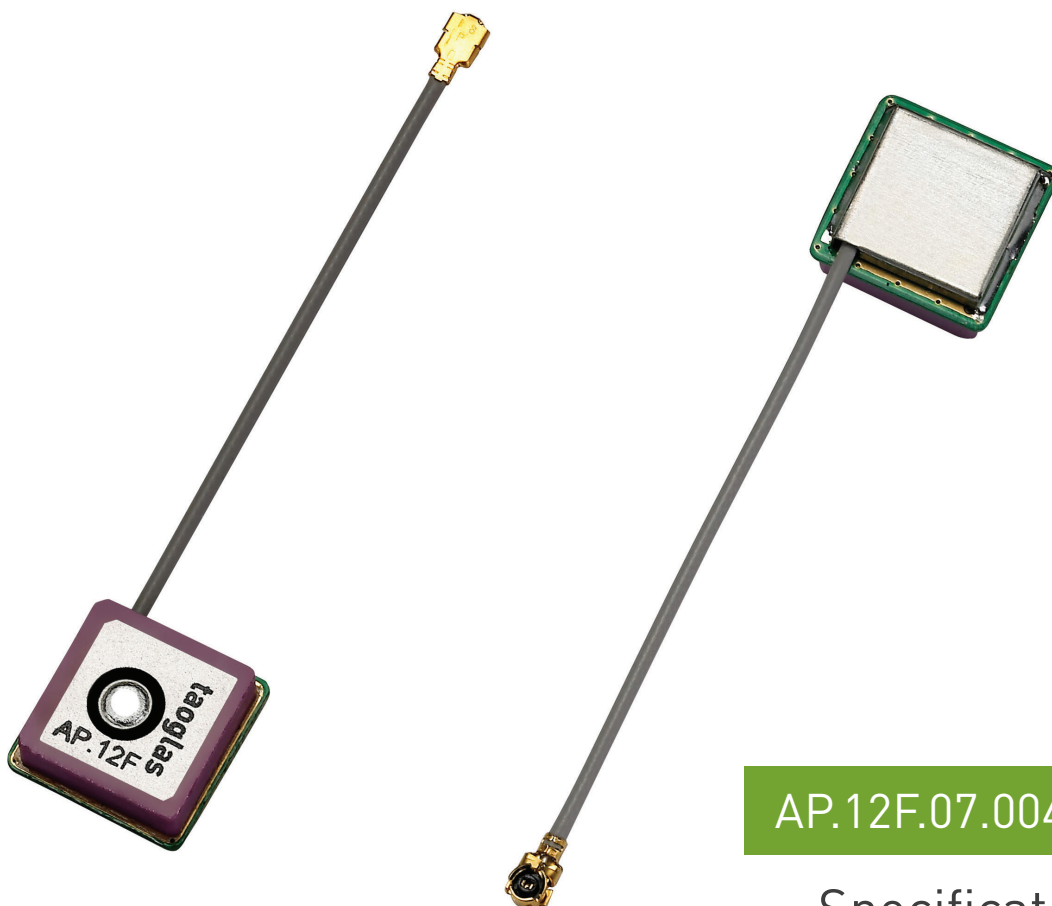

AP.12F.07.0045A

Specification

Part No.	AP.12F.07.0045A
Product Name	12mm Two Stage 25dB GPS Active Patch Antenna Module with front-end Saw Filter
Feature	13.4*13.4*5.7mm (Ground Plane) 45mm Ø1.13 cable IPEX MHFI (U.FL) 28dB LNA Wide Input Voltage 1.8V to 5.5V Low Power Consumption RoHS Compliant



1. Introduction

The AP.12F has been designed specifically for embedded (inside device) integration with GPS receiver modules where there is a GSM transmitter nearby and risk of interference and saturation.

The AP.12F combines a 12*12*3.5mm advanced low profile ceramic patch antenna with a two stage LNA and a front-end SAW filter with ultra thin coaxial cable.

Only 5.6mm in height, this Taoglas active antenna module utilises XtremeGain™ technology for the highest industry sensitivity. The AP.12F consists of 2 functional blocks – the LNA and also the patch antenna.

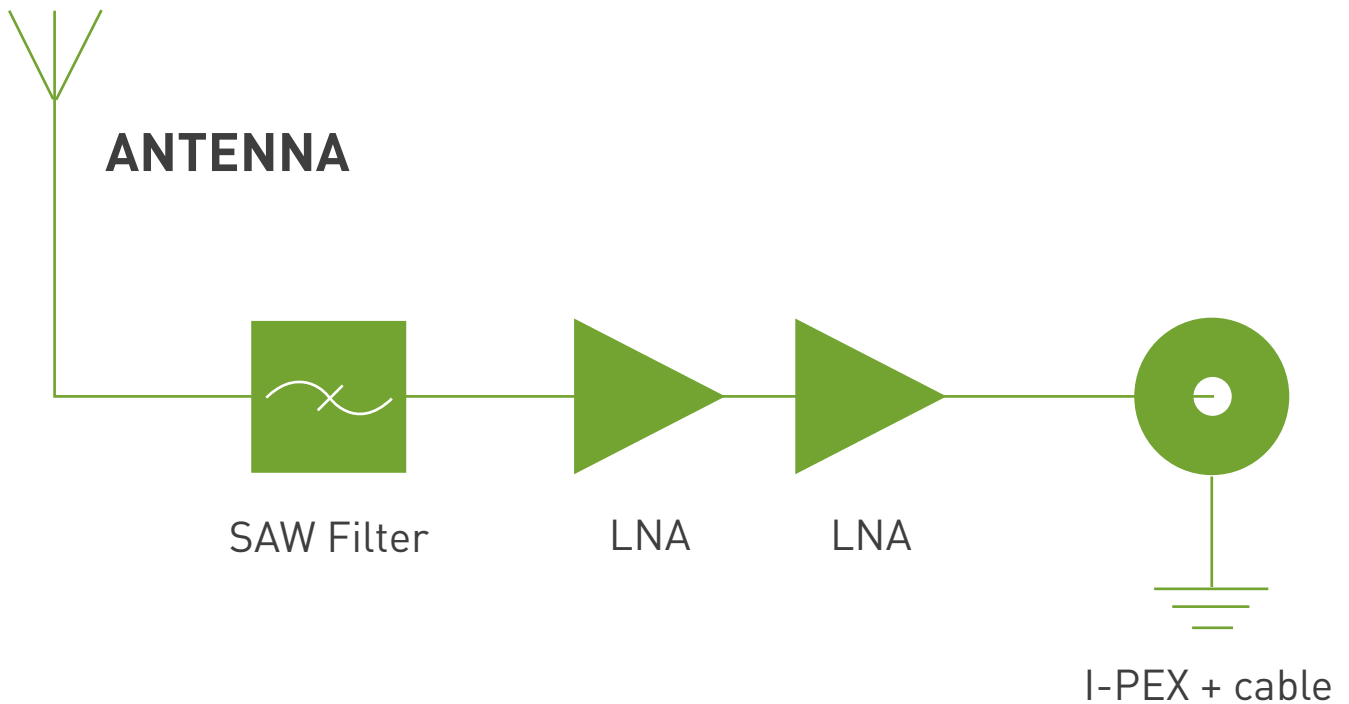

The AP.12F has a SAW filter on the front of it.

The main use of the AP.12F would be for small devices where the GSM transmitter is close to the GPS antenna,

it helps avoid burn-out of the LNA or the module due to interference from the GSM transmitter at out band frequencies.



2. Specification

2.1 Patch Antenna

Parameter	Specification
Frequency	1575.42 ± 1.023MHz
Gain @ Zenith	-5dBic Typ. @ Zenith
Polarization	RHCP
Axial Ratio	4.0dB max @ Zenith
Patch Dimension	12*12*3.5mm

2.2 LNA

Parameter	Specification
Frequency	1575.42 ± 1.023MHz
Outer Band Attenuation	F0=1575.42MHz F0±30MHz 8dB min. F0±50MHz 20dB min. F0±100MHz 25dB min.
Output Impedance	50Ω
Output VSWR	2.0 Max
Pout at 1dB Gain	Typ. 11dBm
Compression point	Min. 5dBm

LNA Gain, Power Consumption and Noise Figure

Voltage	LNA Gain (Typ)	Power Consumption(mA) Typ	Noise Figure Typ
Min. 1.8V	20dB	4mA	2.0dB
Typ. 3.0V	28dB	9mA	2.0dB
Max. 5.5V	29dB	20mA	2.0dB

2.3 Cable* & Connector

Parameter	Specification
RF Cable	Coaxial Cable Ø 1.13 ± 0.1mm, length 45 ± 2.5mm
Connector	IPEX MHFI (U.FL)



3. LNA Gain and Out Band Rejection @3.0V



Cg1	Tr1	S21	>1	1.5754200 GHz	28.206	dB
Cg1	Tr1	S21	2	1.6054200 GHz	18.456	dB
Cg1	Tr1	S21	3	1.5454200 GHz	13.008	dB
Cg1	Tr1	S21	4	1.6254200 GHz	-15.497	dB
Cg1	Tr1	S21	5	1.5254200 GH	7.6131	dB
Cg1	Tr1	S21	6	1.6754200 GHz	-4.3556	dB
Cg1	Tr1	S21	7	1.4754200 GHz	2.6855	dB



4. LNA Noise Figure @3.0V

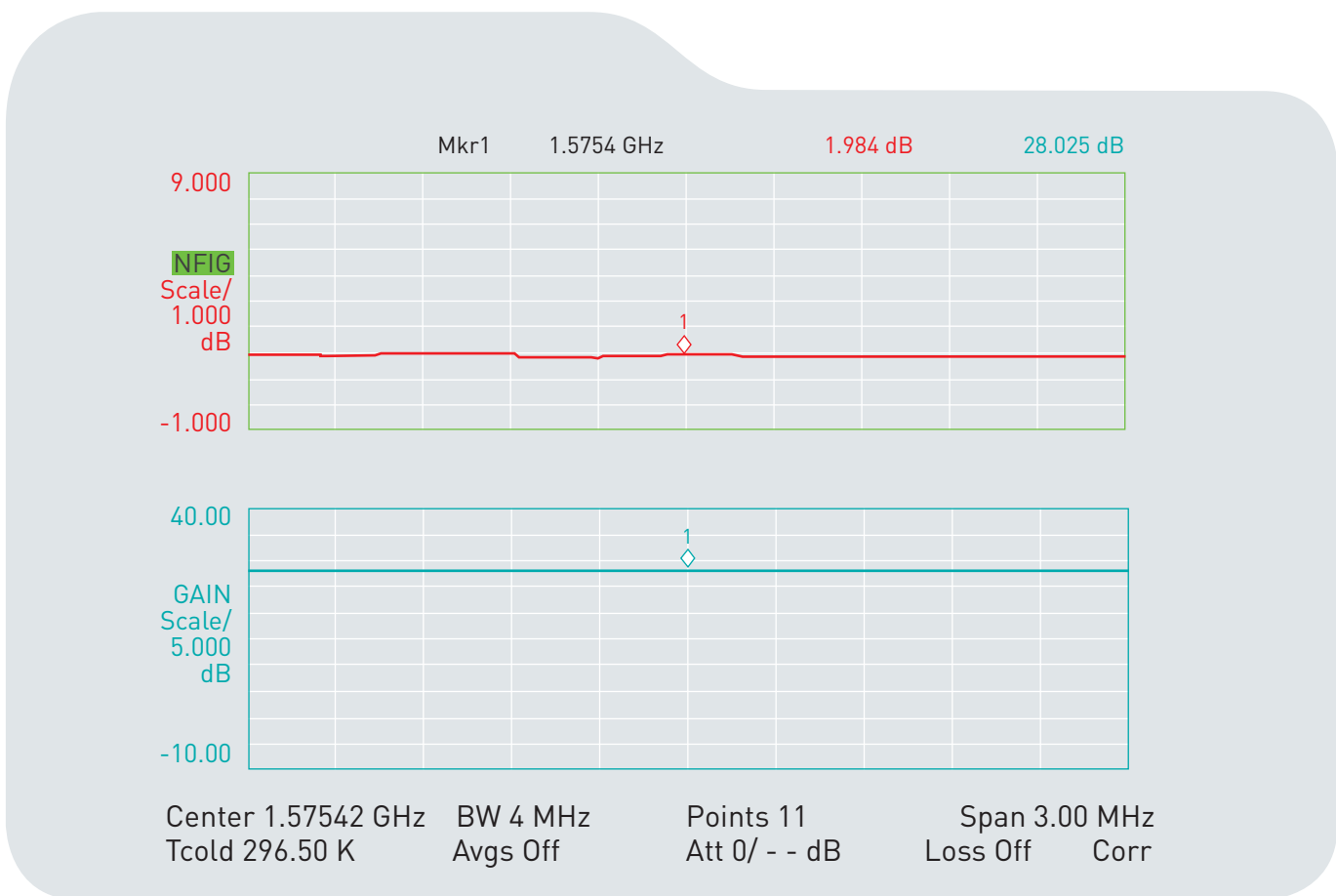

5. Total Specification (through Antenna, LNA, Cable and Connector)

Parameter	Specification
Frequency	1575.42 ± 1.023MHz
Gain	At 3V: 23 ± 4dBic @ 90°
Output Impedance	50Ω
Polarization	RHCP
Output VSWR	Max 2.0
Operation Temperature	-40°C to + 85°C
Storage Temperature	-40°C to + 85°C
Relative Humidity	40% to 95%
Input Voltage	Min. 1.8V, Typ. 3.0V, Max. 5V
Antenna	13.4*13.4*5.7mm



6. Radiation Patterns

6.1 XZ Plane Radiation

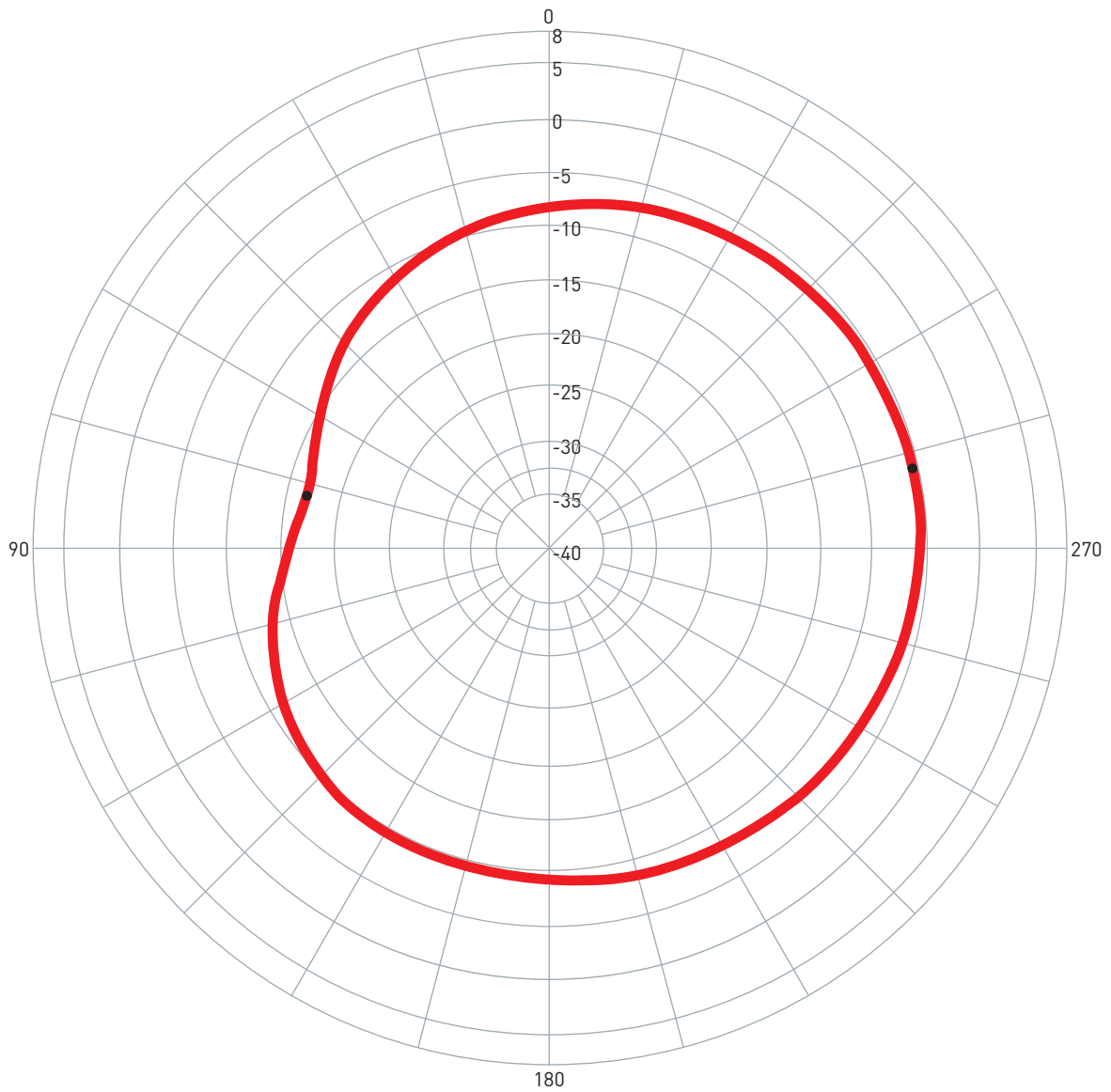

Pattern	Model No.	Test Mode	Freq (MHz)	Max Gain(dBi)	Min Gain(dBi)	Avg. Gain(dBi)	Source Polar.	Date
1	AP.12F.07.0045A	XZ	1612.00	-5.64 / 282.00	-16.83 / 77.00	-8.49	RHCP	2010/4/19



6.2 YZ Plane Radiation

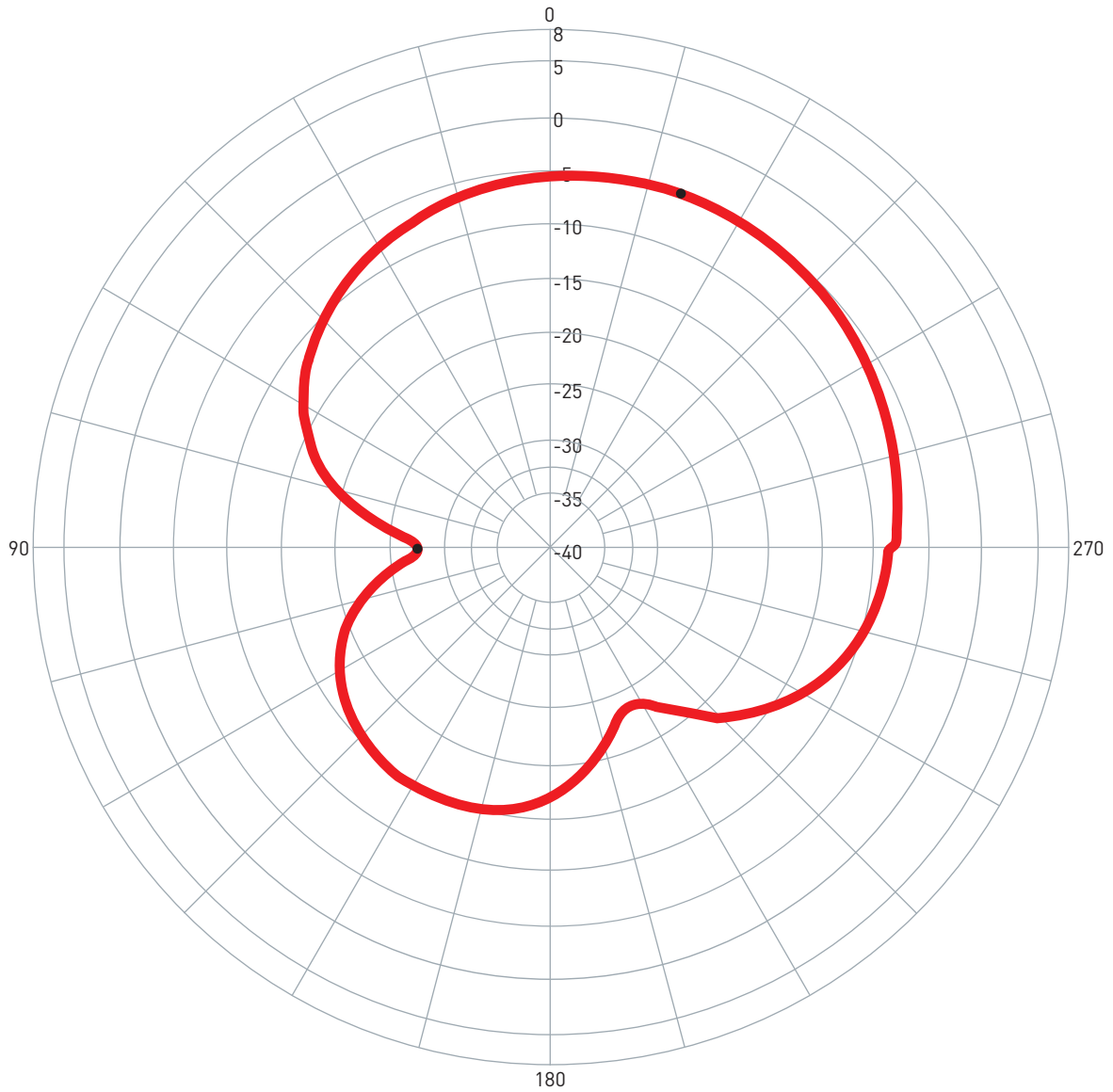

Pattern	Model No.	Test Mode	Freq (MHz)	Max Gain(dBi)	Min Gain(dBi)	Avg. Gain(dBi)	Source Polar.	Date
1	AP.12F.07.0045A	YZ	1612.00	-5.08 / 340.00	-27.50 / 91.00	-9.64	RHCP	2010/4/19



6.3 XY Plane Radiation

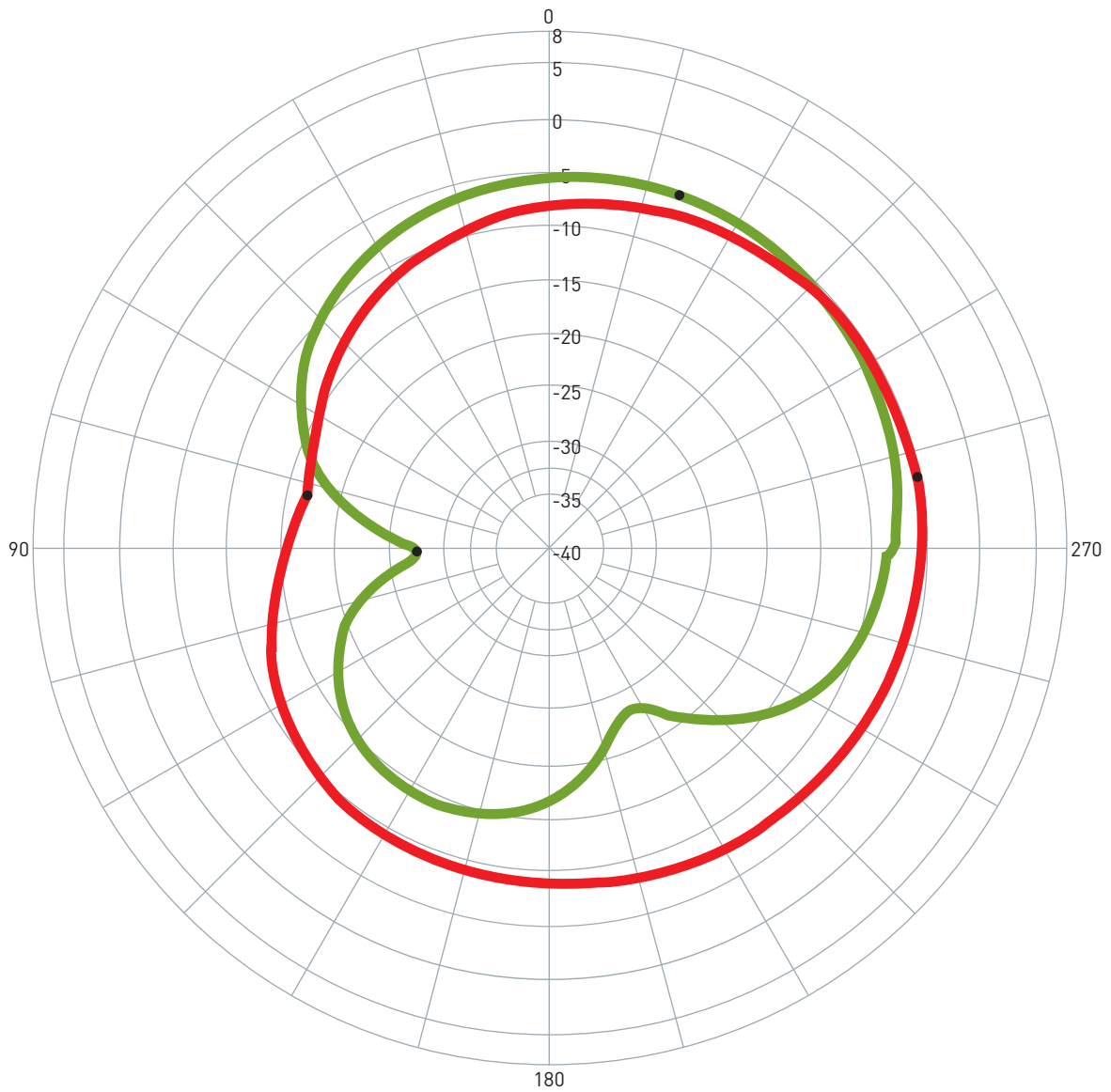

Pattern	Model No.	Test Mode	Freq (MHz)	Max Gain(dBi)	Min Gain(dBi)	Avg. Gain(dBi)	Source Polar.	Date
1	AP.12F.07.0045A	XZ	1612.00	-5.64 / 282.00	-16.83 / 77.00	-8.49	RHCP	2010/4/19
2	AP.12F.07.0045A	YZ	1612.00	-5.08 / 340.00	-27.50 / 91.00	-9.64	RHCP	2010/4/19



7. Technical Drawing

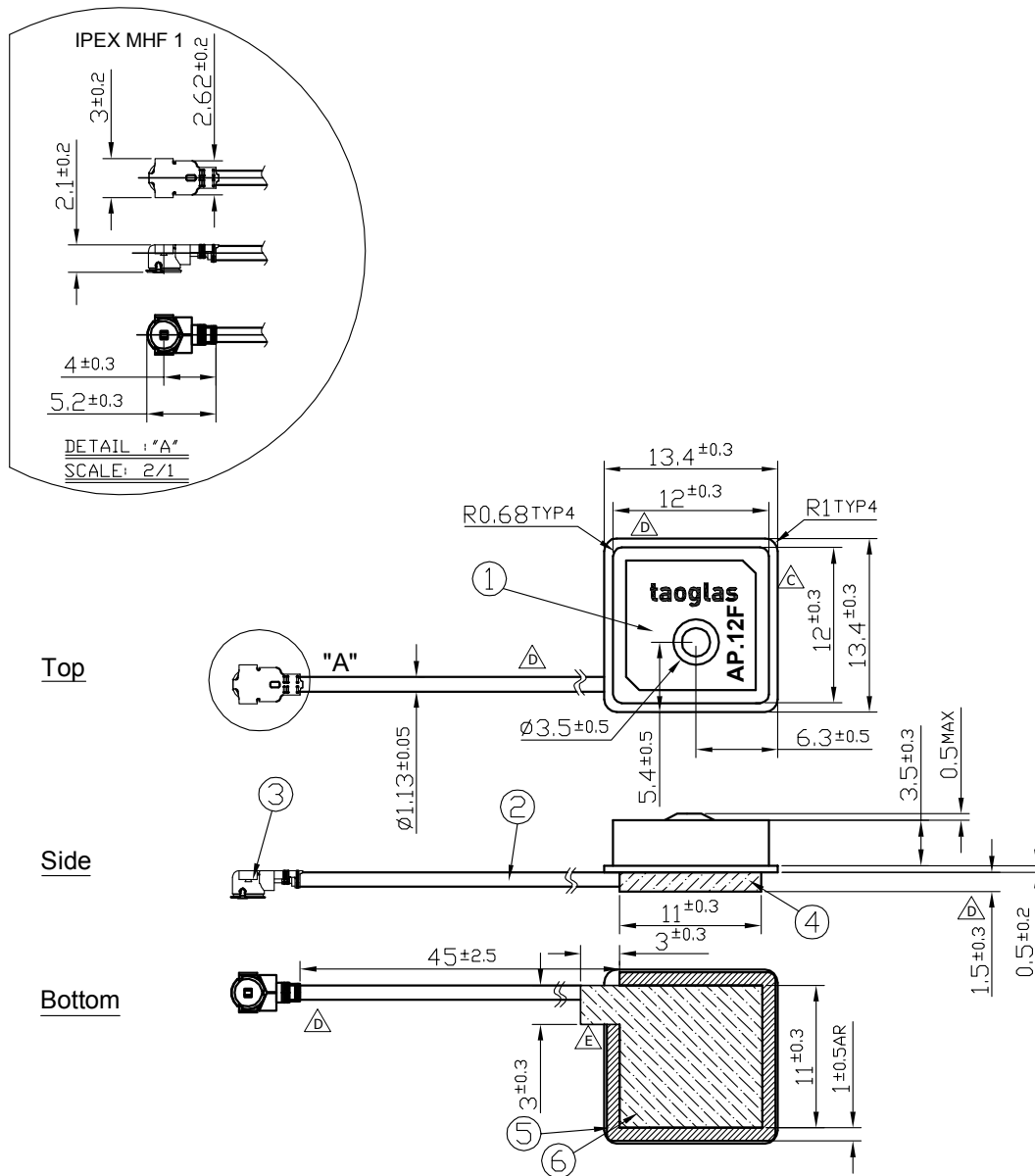

NOTE:

1. Soldered area
2. Shielding case area
3. All material must be RoHS compliant.
4. The connector orientation has a fixed position to the antenna as per drawing.

	Name	P/N	Material	Finish	QTY
1	AP.12F Patch(12*12*4mm)	AP.12F	Ceramic	Clear	1
2	1.13 Coaxial Cable	OD.113.CM	FEP	Gray	1
3	IPEX MHF1	IPEX.MHF1.113	Brass	Gold	1
4	Shielding Case		Tin (SPTE)	Tin Plated	1
5	AP.12F PCB		FR4 0.5t	Green	1
6	Double Sided Adhesive		NITTO 5015	White Liner	1



8. Plugs Usage Precautions

8.1 Mating / unmating

(1) To disconnect connectors, insert the end portion of I-PEX under the connector flanges and pull off vertically, in the direction of the connector mating axis.

(2) To mate the connectors, the mating axes of both connectors must be aligned and the connectors can be mated. The "click" will confirm fully mated connection.

Do not attempt to insert on an extreme angle.

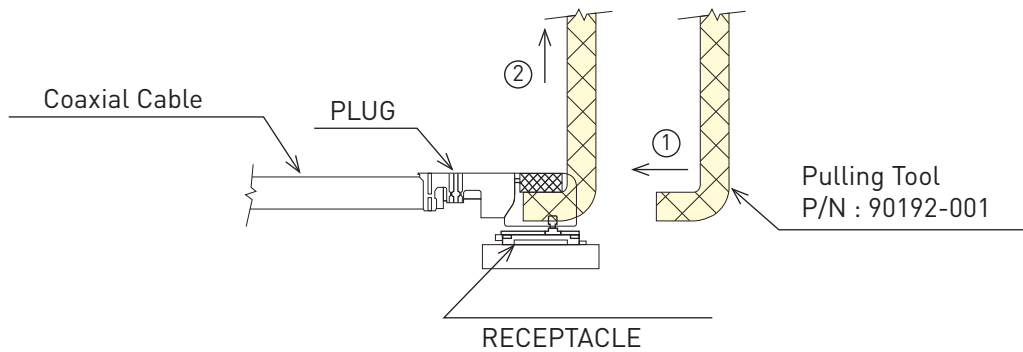

8.2 Pull forces on the cable after connectors are mated

After the connectors are mated, do not apply a load to the cable in excess of the values indicated in the diagram below.

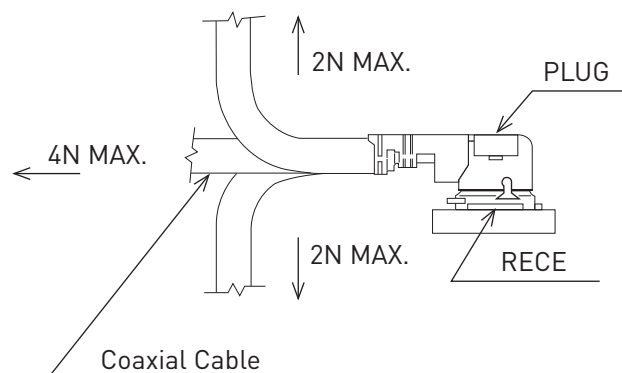



9. Packaging

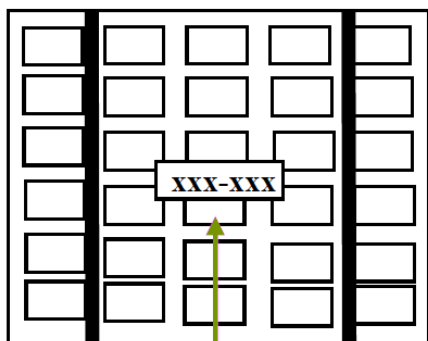

- *Packaged in Tray with Foam
- *One Tray = 60 pieces
- *6 Trays per Section = 360 pcs

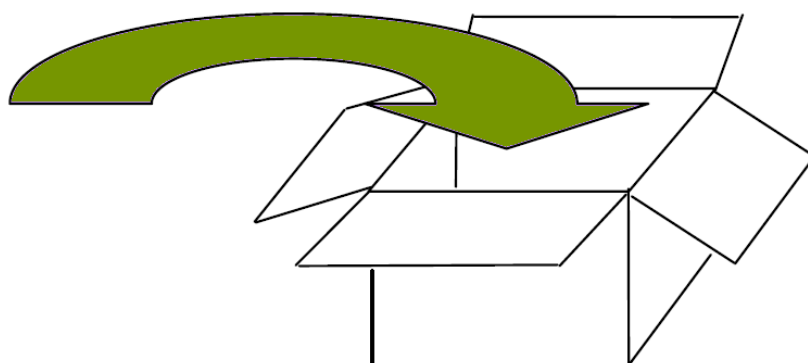

- *Each Carton contains 3 Sections
- *1080 pieces per Carton