

Excellent Integrated System Limited

Stocking Distributor

Click to view price, real time Inventory, Delivery & Lifecycle Information:

[Sanken](#)
[2SC3835](#)

For any questions, you can email us directly:

sales@integrated-circuit.com

2SC3835

Silicon NPN Triple Diffused Planar Transistor (Switching Transistor)

Application : Humidifier, DC-DC Converter, and General Purpose

Absolute maximum ratings (Ta=25°C)

Symbol	Ratings	Unit
V _{CB0}	200	V
V _{CEO}	120	V
V _{EBO}	8	V
I _C	7(Pulse14)	A
I _B	3	A
P _C	70(T _C =25°C)	W
T _J	150	°C
T _{stg}	-55 to +150	°C

Electrical Characteristics (Ta=25°C)

Symbol	Conditions	Ratings	Unit
I _{CB0}	V _{CB} =200V	100max	μA
I _{EBO}	V _{EB} =8V	100max	μA
V _{(BR)CEO}	I _C =50mA	120min	V
h _{FE}	V _{CE} =4V, I _C =3A	70to220	
V _{CE(sat)}	I _C =3A, I _B =0.3A	0.5max	V
V _{BE(sat)}	I _C =3A, I _B =0.3A	1.2max	V
f _T	V _{CE} =12V, I _E =-0.5A	30typ	MHz
COB	V _{CB} =10V, f=1MHz	110typ	pF

External Dimensions MT-100(TO3P)

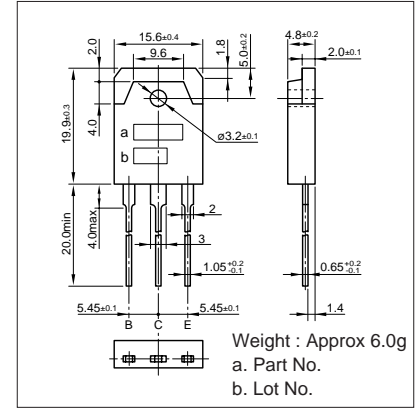

Typical Switching Characteristics (Common Emitter)

V _{CC} (V)	R _L (Ω)	I _C (A)	V _{BB1} (V)	V _{BB2} (V)	I _{B1} (A)	I _{B2} (A)	t _{on} (μs)	t _{stg} (μs)	t _f (μs)
50	16.7	3	10	-5	0.3	-0.6	0.5max	3.0max	0.5max

I_C-V_{CE} Characteristics (Typical)

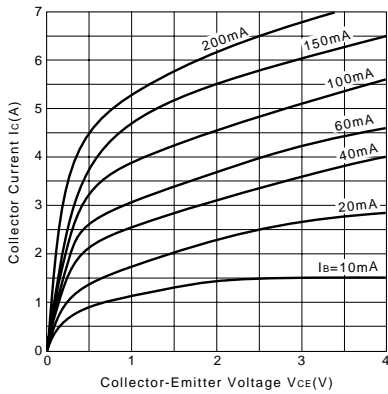

V_{CE(sat)}-I_B Characteristics (Typical)

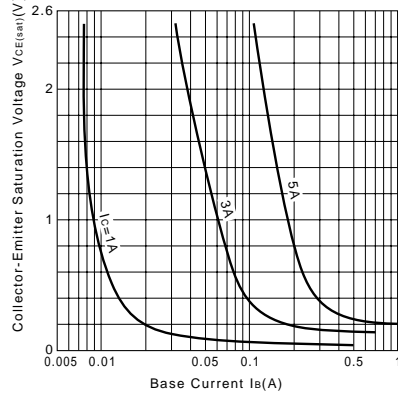

I_C-V_{BE} Temperature Characteristics (Typical)

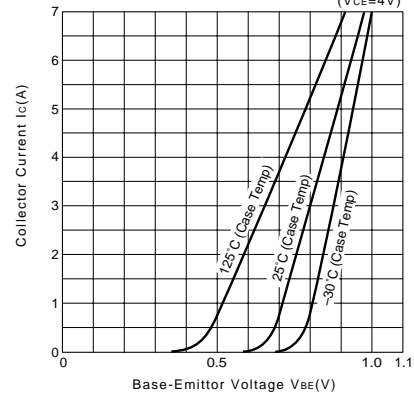

h_{FE}-I_C Characteristics (Typical)

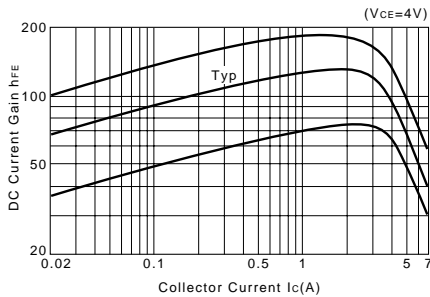

h_{FE}-I_C Temperature Characteristics (Typical)

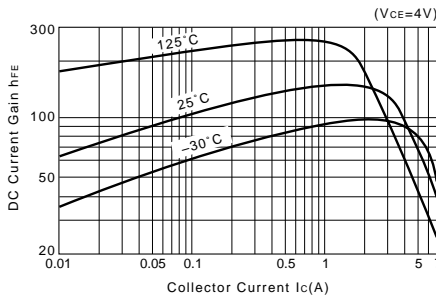

θ_{j-a}-t Characteristics

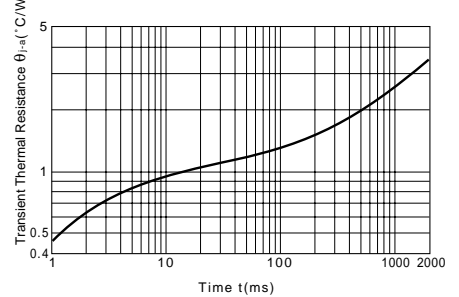

f_T-I_E Characteristics (Typical)

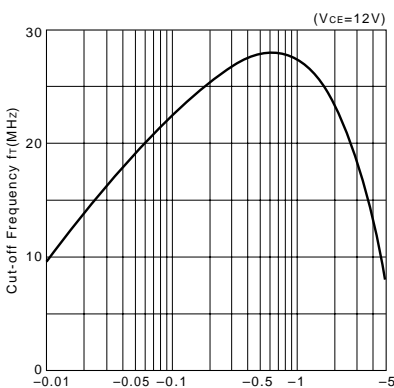

Safe Operating Area (Single Pulse)

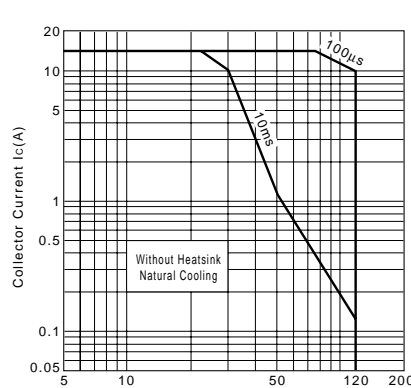

P_C-T_a Derating

