

Excellent Integrated System Limited

Stocking Distributor

Click to view price, real time Inventory, Delivery & Lifecycle Information:

[Sanken](#)
[2SC5130](#)

For any questions, you can email us directly:

sales@integrated-circuit.com

2SC5130

Silicon NPN Triple Diffused Planar Transistor (High Voltage and High Speed Switching Transistor) **Application :** Switching Regulator and General Purpose

Absolute maximum ratings (Ta=25°C)

Symbol	Ratings	Unit
V _{CB0}	600	V
V _{CEO}	400	V
V _{EB0}	10	V
I _C	5(Pulse10)	A
I _B	2	A
P _C	30(Tc=25°C)	W
T _J	150	°C
T _{stg}	-55 to +150	°C

Electrical Characteristics (Ta=25°C)

Symbol	Conditions	Ratings	Unit
I _{CB0}	V _{CB} =500V	100max	μA
I _{EB0}	V _{EB} =10V	10max	μA
V(BR)CEO	I _C =25mA	400min	V
h _{FE}	V _{CE} =4V, I _C =1.5A	10 to 30	
V _{CE(sat)}	I _C =1.5A, I _B =0.3A	0.5max	V
V _{BE(sat)}	I _C =1.5A, I _B =0.3A	1.3max	V
f _T	V _{CE} =12V, I _E =-0.3A	20typ	MHZ
COB	V _{CB} =10V, f=1MHZ	30typ	pF

External Dimensions FM20(TO220F)

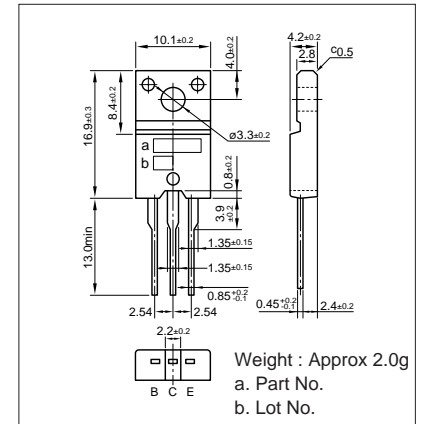

Typical Switching Characteristics (Common Emitter)

V _{CC} (V)	R _L (Ω)	I _C (A)	V _{BB1} (V)	V _{BB2} (V)	I _{B1} (A)	I _{B2} (A)	t _{on} (μs)	t _{stg} (μs)	t _f (μs)
200	133	1.5	10	-5	0.15	-0.3	1max	2max	0.3max

I_C-V_{CE} Characteristics (Typical)

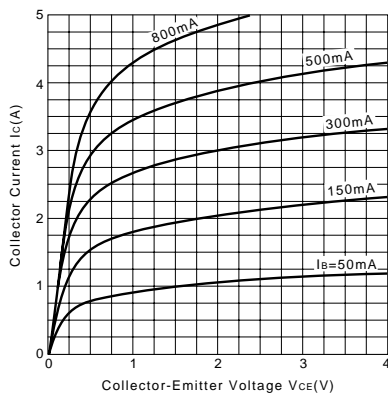

V_{CE(sat)}-I_C Characteristics (Typical)

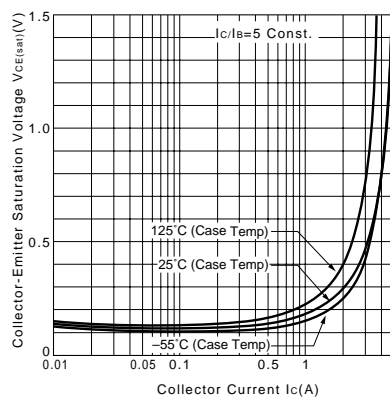

I_C-V_{BE} Temperature Characteristics (Typical)

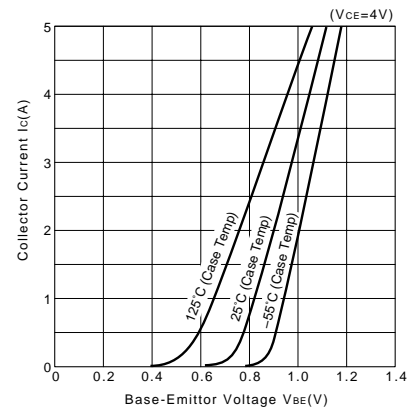

h_{FE}-I_C Characteristics (Typical)

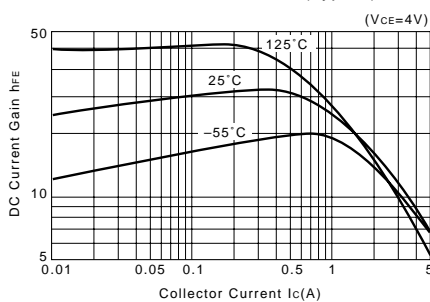

t_{on}*t_{stg}*t_f-I_C Characteristics (Typical)

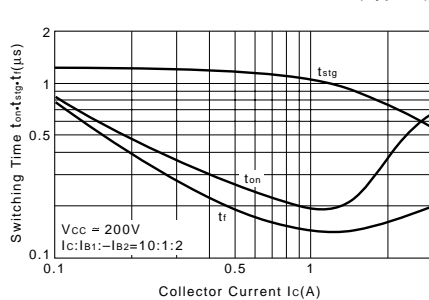

θ_{j-a}-t Characteristics

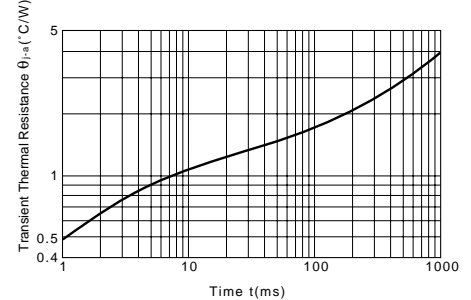

Safe Operating Area (Single Pulse)

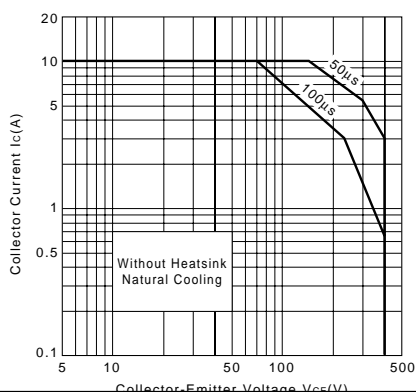

Reverse Bias Safe Operating Area

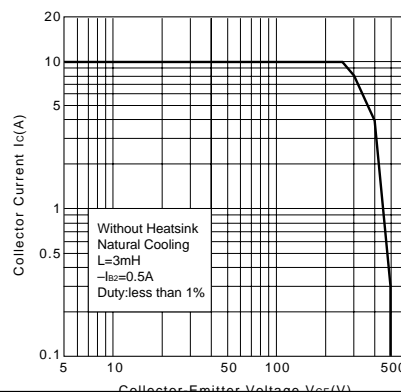

P_C-T_a Derating

