

## Excellent Integrated System Limited

Stocking Distributor

Click to view price, real time Inventory, Delivery & Lifecycle Information:

[Sanken](#)  
[2SD2642](#)

For any questions, you can email us directly:

[sales@integrated-circuit.com](mailto:sales@integrated-circuit.com)

# Darlington 2SD2642

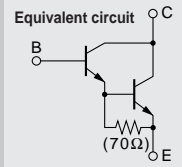

Silicon NPN Triple Diffused Planar Transistor (Complement to type 2SB1687)

Application : Audio, Series Regulator and General Purpose

■ Absolute maximum ratings (Ta=25°C)

Symbol	Ratings	Unit
VCBO	110	V
VCEO	110	V
VEBO	5	V
Ic	6	A
Ib	1	A
Pc	30(Tc=25°C)	W
Tj	150	°C
Tstg	-55 to +150	°C

■ Electrical Characteristics (Ta=25°C)

Symbol	Conditions	Ratings	Unit
ICBO	V <sub>CB</sub> =110V	100max	μA
IEBO	V <sub>EB</sub> =5V	100max	μA
V(BR)CEO	I <sub>C</sub> =30mA	110min	V
hFE	V <sub>CE</sub> =4V, I <sub>C</sub> =5A	5000min*	
V <sub>CE(sat)</sub>	I <sub>C</sub> =5A, I <sub>B</sub> =5mA	2.5max	V
V <sub>BE(sat)</sub>	I <sub>C</sub> =5A, I <sub>B</sub> =5mA	3.0max	V
f <sub>T</sub>	V <sub>CE</sub> =12V, I <sub>E</sub> =-0.5A	60typ	MHz
COB	V <sub>CB</sub> =10V, f=1MHz	55typ	pF

\*hFE Rank  $\bar{O}$ (5000 to 12000), P(6500 to 20000), Y(15000 to 30000)

■ Typical Switching Characteristics (Common Emitter)

V <sub>CC</sub> (V)	R <sub>L</sub> (Ω)	I <sub>C</sub> (A)	V <sub>BB1</sub> (V)	V <sub>BB2</sub> (V)	I <sub>B1</sub> (mA)	I <sub>B2</sub> (mA)	t <sub>on</sub> (μs)	t <sub>stg</sub> (μs)	t <sub>f</sub> (μs)
30	6	5	10	-5	5	-5	0.8typ	6.2typ	1.1typ

External Dimensions FM20(TO220F)

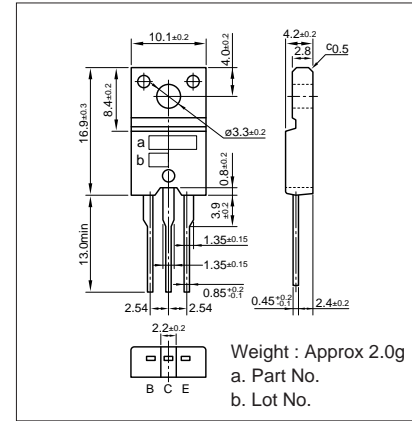

I<sub>C</sub>-V<sub>CE</sub> Characteristics (Typical)

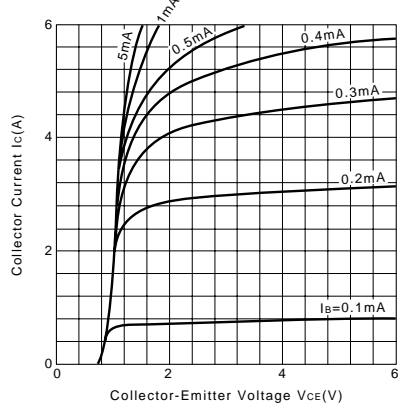

V<sub>CE(sat)</sub>-I<sub>B</sub> Characteristics (Typical)

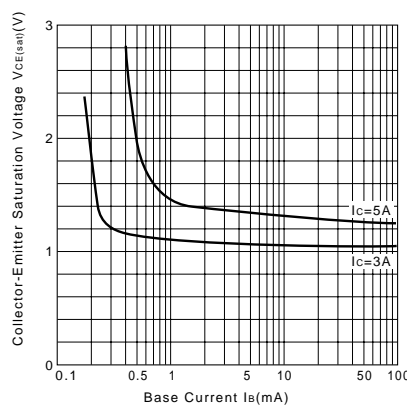

I<sub>C</sub>-V<sub>BE</sub> Temperature Characteristics (Typical)

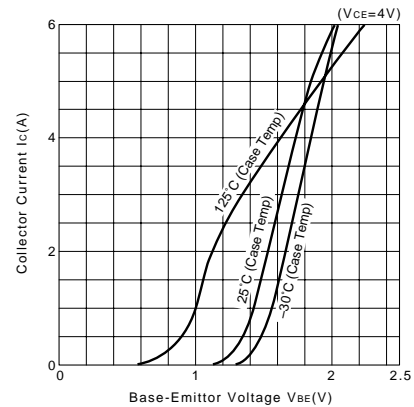

h<sub>FE</sub>-I<sub>C</sub> Characteristics (Typical)

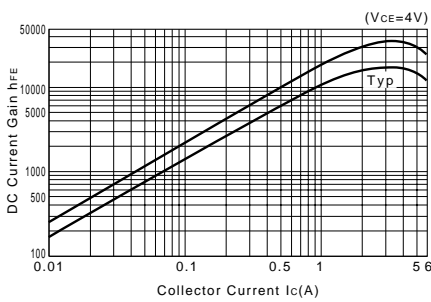

h<sub>FE</sub>-I<sub>C</sub> Temperature Characteristics (Typical)

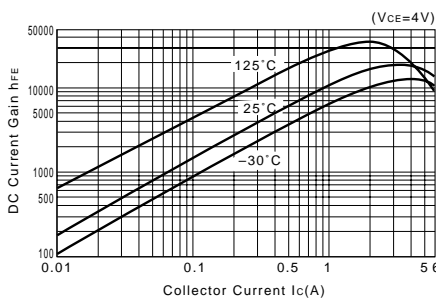

θ<sub>j-a</sub>-t Characteristics

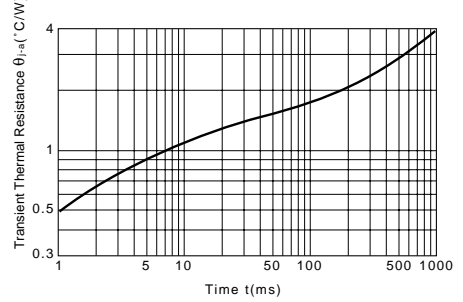

f<sub>T</sub>-I<sub>E</sub> Characteristics (Typical)

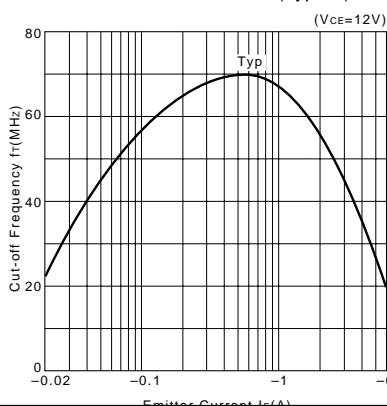

Safe Operating Area (Single Pulse)

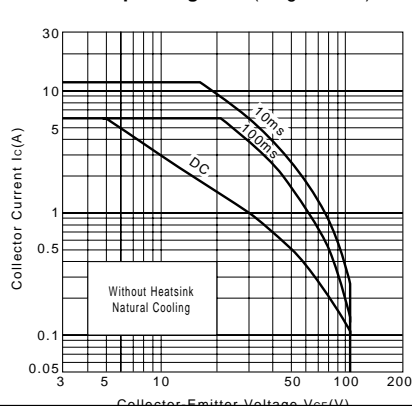

P<sub>c</sub>-T<sub>a</sub> Derating

