

## Excellent Integrated System Limited

Stocking Distributor

Click to view price, real time Inventory, Delivery & Lifecycle Information:

[Rohm Semiconductor](#)  
[BA00AST](#)

For any questions, you can email us directly:

[sales@integrated-circuit.com](mailto:sales@integrated-circuit.com)

## Regulator ICs

# Regulator, low drop-out type with ON/OFF switch

## BAOOST / BAOOSFP series

The BAOOST and BAOOSFP series are variable, fixed output low drop-out type voltage regulators with an ON/OFF switch.

These regulators are used to provide a stabilized output voltage from a fluctuating DC input voltage.

Fixed output voltages are 3.3V, 5V, 6V(SFP), 7V, 8V, 9V, 10V(ST), 12V(ST). The maximum current capacity is 1 A for each of the above voltages.

### ●Application

Constant voltage power supply

### ●Features

- 1) Built-in overvoltage protection circuit, overcurrent protection circuit and thermal shutdown circuit
- 2) TO220FP-5, TO252-5 standard packages can be accommodated in wide application.
- 3) 0 $\mu$ A (design value) circuit current when switch is off
- 4) Richly diverse lineup.
- 5) Low minimum I/O voltage differential.

### ●Product codes

Output voltage (V)	Product No.	Output voltage (V)	Product No.
Variable	BA00AST / ASFP	8.0	BA08ST / SFP
3.3	BA033ST / SFP	9.0	BA09ST / SFP
5.0	BA05ST / SFP	10.0	BA10ST
6.0	BA06SFP	12.0	BA12ST
7.0	BA07ST / SFP		

### ●Absolute maximum ratings (Ta=25°C)

Parameter	Symbol	Limits	Unit
Power supply voltage	V <sub>cc</sub>	35	V
Power dissipation	Pd	2000 <sup>*1</sup>	mW
		1000 <sup>*2</sup>	
Operating temperature	Topr	-40~+85	°C
Storage temperature	Tstg	-55~+150	°C
Peak applied voltage	V <sub>surge</sub>	50 <sup>*3</sup>	V

<sup>\*1</sup> Reduced by 16mW for each increase in Ta of 1°C over 25°C.

<sup>\*2</sup> Reduced by 8mW for each increase in Ta of 1°C over 25°C.

<sup>\*3</sup> Voltage application time : 200 msec. or less

**Regulator ICs**

**●Block diagram**

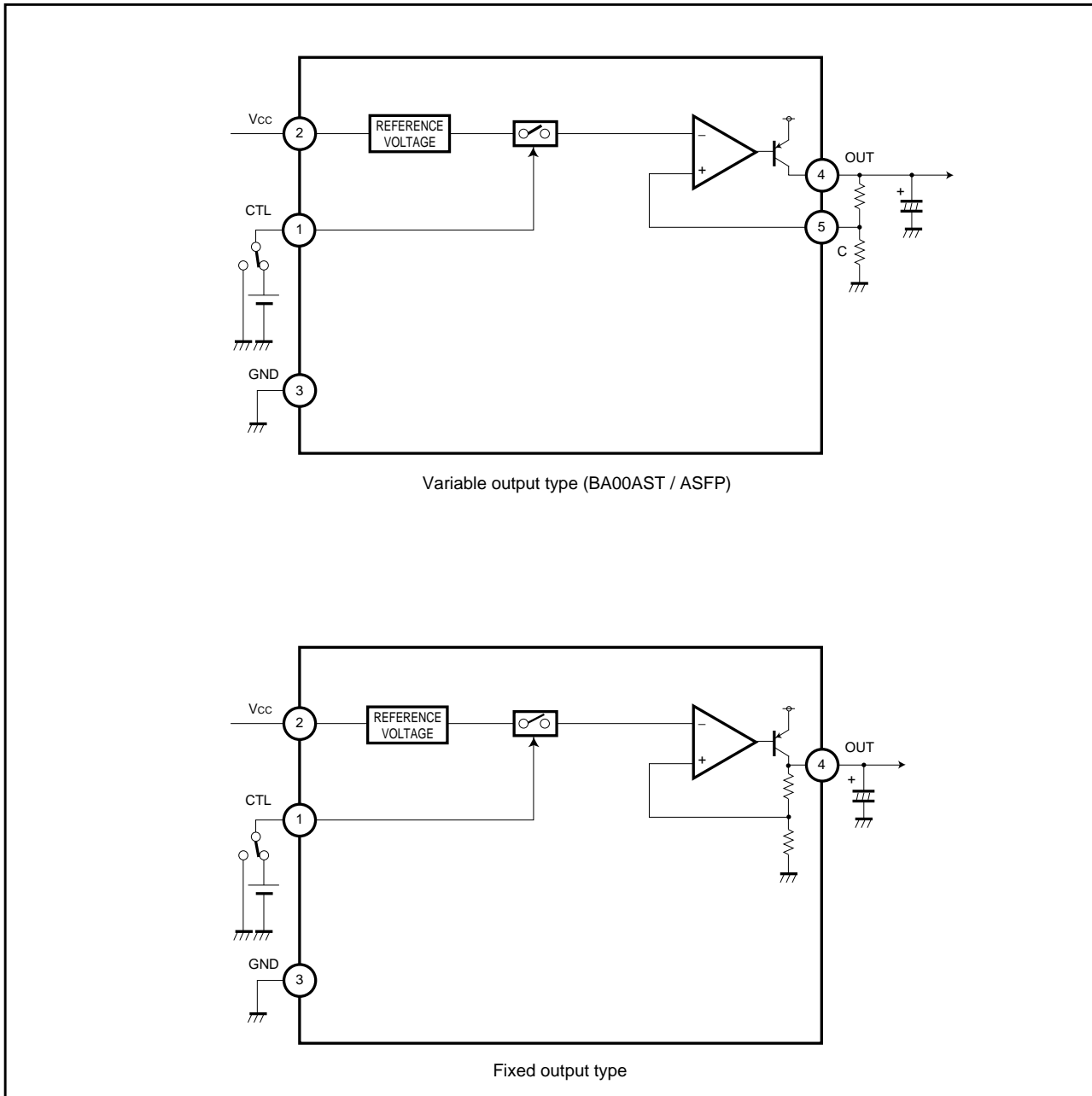

**●Pin descriptions**

Pin No.	Pin name	Function
1	CTL	Output ON/OFF
2	Vcc	Power supply input
3	GND	Ground
4	OUT	Output
5	C	Reference power supply pin for setting voltage with the BA00AST/ASFP.
	N.C.	In the BAOOST/SFP Series, these are NC pins, except for the BA00AST/ASFP.

## Regulator ICs

### ●Recommended operating conditions

#### BA00AST / ASFP

Parameter	Symbol	Min.	Max.	Unit
Input voltage	V <sub>CC</sub>	4	25	V
Output current	I <sub>o</sub>	-	1	A

#### BA033ST / SFP

Parameter	Symbol	Min.	Max.	Unit
Input voltage	V <sub>CC</sub>	4.3	25	V
Output current	I <sub>o</sub>	-	1	A

#### BA05ST / SFP

Parameter	Symbol	Min.	Max.	Unit
Input voltage	V <sub>CC</sub>	6	25	V
Output current	I <sub>o</sub>	-	1	A

#### BA06SFP

Parameter	Symbol	Min.	Max.	Unit
Input voltage	V <sub>CC</sub>	7	25	V
Output current	I <sub>o</sub>	-	1	A

#### BA07ST / SFP

Parameter	Symbol	Min.	Max.	Unit
Input voltage	V <sub>CC</sub>	8	25	V
Output current	I <sub>o</sub>	-	1	A

#### BA08ST / SFP

Parameter	Symbol	Min.	Max.	Unit
Input voltage	V <sub>CC</sub>	9	25	V
Output current	I <sub>o</sub>	-	1	A

#### BA09ST / SFP

Parameter	Symbol	Min.	Max.	Unit
Input voltage	V <sub>CC</sub>	10	25	V
Output current	I <sub>o</sub>	-	1	A

#### BA10ST

Parameter	Symbol	Min.	Max.	Unit
Input voltage	V <sub>CC</sub>	11	25	V
Output current	I <sub>o</sub>	-	1	A

#### BA12ST

Parameter	Symbol	Min.	Max.	Unit
Input voltage	V <sub>CC</sub>	13	25	V
Output current	I <sub>o</sub>	-	1	A

### ●Electrical characteristics

 BA00AST / ASFP (unless otherwise noted, T<sub>a</sub>=25°C, V<sub>CC</sub>=10V, I<sub>o</sub>=500mA)

Parameter	Symbol	Min.	Typ.	Max.	Unit	Conditions	Measurement circuit
Reference voltage	V <sub>ref</sub>	1.200	1.225	1.250	V		Fig.1
Power save current	I <sub>st</sub>	-	0	10	μA	OFF mode	Fig.4
Output voltage	V <sub>o</sub>	-	5.0	-	V		Fig.1
Input stability	Reg.I	-	20	100	mV	V <sub>CC</sub> =6→25V	Fig.1
Ripple rejection ratio	R.R.	45	55	-	dB	e <sub>IN</sub> =1V <sub>rms</sub> , f=120Hz, I <sub>o</sub> =100mA	Fig.2
Load regulation	Reg.L	-	50	150	mV	I <sub>o</sub> =5mA→1A	Fig.1
Temperature coefficient of output voltage	T <sub>CVo</sub>	-	±0.01	-	% / °C	I <sub>o</sub> =5mA, T <sub>j</sub> =0~125°C	Fig.1
Minimum I/O voltage differential	V <sub>d</sub>	-	0.3	0.5	V	V <sub>CC</sub> =0.95V <sub>o</sub>	Fig.3
Bias current	I <sub>b</sub>	-	2.5	5.0	mA	I <sub>o</sub> =0mA	Fig.4
Peak output current	I <sub>o</sub>	1.0	1.5	-	A	T <sub>j</sub> =25°C	Fig.1
Output short-circuit current	I <sub>os</sub>	-	0.4	-	A	V <sub>CC</sub> =25V	Fig.5
ON mode voltage	V <sub>th1</sub>	2.0	-	-	V	Output Active mode, I <sub>o</sub> =0mA	Fig.6
OFF mode voltage	V <sub>th2</sub>	-	-	0.8	V	Output OFF mode, I <sub>o</sub> =0mA	Fig.6
Input high level current	I <sub>IN</sub>	100	200	300	μA	CTL=5V, I <sub>o</sub> =0mA	Fig.6

## Regulator ICs

BA033ST / SFP (unless otherwise noted, Ta=25°C, Vcc=8 V, Io=500 mA)

Parameter	Symbol	Min.	Typ.	Max.	Unit	Conditions	Measurement circuit
Power save current	I <sub>ST</sub>	-	0	10	μA	OFF mode	Fig.4
Output voltage	V <sub>O1</sub>	3.13	3.3	3.47	V		Fig.1
Input stability	Reg.I	-	20	100	mV	V <sub>CC</sub> =4→25V	Fig.1
Ripple rejection ratio	R.R.	45	55	-	dB	e <sub>IN</sub> =1Vrms, f=120Hz, I <sub>O</sub> =100mA	Fig.2
Load regulation	Reg.L	-	50	150	mV	I <sub>O</sub> =5mA→1A	Fig.1
Temperature coefficient of output voltage	T <sub>CV0</sub>	-	±0.02	-	% / °C	I <sub>O</sub> =5mA, T <sub>J</sub> =0~125°C	Fig.1
Minimum I/O voltage differential	V <sub>d</sub>	-	0.3	0.5	V	V <sub>CC</sub> =0.95V <sub>O</sub>	Fig.3
Bias current	I <sub>b</sub>	-	2.5	5.0	mA	I <sub>O</sub> =0mA	Fig.4
Peak output current	I <sub>O</sub>	1.0	1.5	-	A	T <sub>J</sub> =25°C	Fig.1
Output short-circuit current	I <sub>OS</sub>	-	0.4	-	A	V <sub>CC</sub> =25V	Fig.5
ON mode voltage	V <sub>th1</sub>	2.0	-	-	V	Output Active mode, I <sub>O</sub> =0mA	Fig.6
OFF mode voltage	V <sub>th2</sub>	-	-	0.8	V	Output OFF mode, I <sub>O</sub> =0mA	Fig.6
Input high level current	I <sub>IN</sub>	100	200	300	μA	CTL=5V, I <sub>O</sub> =0mA	Fig.6

BA05ST / SFP (unless otherwise noted, Ta=25°C, Vcc=10 V, Io=500 mA)

Parameter	Symbol	Min.	Typ.	Max.	Unit	Conditions	Measurement circuit
Power save current	I <sub>ST</sub>	-	0	10	μA	OFF mode	Fig.4
Output voltage	V <sub>O1</sub>	4.75	5.0	5.25	V		Fig.1
Input stability	Reg.I	-	20	100	mV	V <sub>CC</sub> =6→2→5V	Fig.1
Ripple rejection ratio	R.R.	45	55	-	dB	e <sub>IN</sub> =1Vrms, f=120Hz, I <sub>O</sub> =100mA	Fig.2
Load regulation	Reg.L	-	50	150	mV	I <sub>O</sub> =5mA→1A	Fig.1
Temperature coefficient of output voltage	T <sub>CV0</sub>	-	±0.02	-	% / °C	I <sub>O</sub> =5mA, T <sub>J</sub> =0~125°C	Fig.1
Minimum I/O voltage differential	V <sub>d</sub>	-	0.3	0.5	V	V <sub>CC</sub> =4.75V	Fig.3
Bias current	I <sub>b</sub>	-	2.5	5.0	mA	I <sub>O</sub> =0mA	Fig.4
Peak output current	I <sub>O</sub>	1.0	1.5	-	A	T <sub>J</sub> =25°C	Fig.1
Output short-circuit current	I <sub>OS</sub>	-	0.4	-	A	V <sub>CC</sub> =25V	Fig.5
ON mode voltage	V <sub>th1</sub>	2.0	-	-	V	Output Active mode, I <sub>O</sub> =0mA	Fig.6
OFF mode voltage	V <sub>th2</sub>	-	-	0.8	V	Output OFF mode, I <sub>O</sub> =0mA	Fig.6
Input high level current	I <sub>IN</sub>	100	200	300	μA	CTL=5V, I <sub>O</sub> =0mA	Fig.6

BA06SFP ( unless otherwise noted, Ta=25°C, Vcc=11 V, Io=500 mA)

Parameter	Symbol	Min.	Typ.	Max.	Unit	Conditions	Measurement circuit
Power save current	I <sub>ST</sub>	-	0	10	μA	OFF mode	Fig.4
Output voltage	V <sub>O1</sub>	5.7	6.0	6.3	V		Fig.1
Input stability	Reg.I	-	20	100	mV	V <sub>CC</sub> =7→25V	Fig.1
Ripple rejection ratio	R.R.	45	55	-	dB	e <sub>IN</sub> =1Vrms, f=120Hz, I <sub>O</sub> =100mA	Fig.2
Load regulation	Reg.L	-	50	150	mV	I <sub>O</sub> =5mA→1A	Fig.1
Temperature coefficient of output voltage	T <sub>CV0</sub>	-	±0.02	-	% / °C	I <sub>O</sub> =5mA, T <sub>J</sub> =0~125°C	Fig.1
Minimum I/O voltage differential	V <sub>d</sub>	-	0.3	0.5	V	V <sub>CC</sub> =5.7V	Fig.3
Bias current	I <sub>b</sub>	-	2.5	5.0	mA	I <sub>O</sub> =0mA	Fig.4
Peak output current	I <sub>O</sub>	1.0	1.5	-	A	T <sub>J</sub> =25°C	Fig.1
Output short-circuit current	I <sub>OS</sub>	-	0.4	-	A	V <sub>CC</sub> =25V	Fig.5
ON mode voltage	V <sub>th1</sub>	2.0	-	-	V	Output Active mode, I <sub>O</sub> =0mA	Fig.6
OFF mode voltage	V <sub>th2</sub>	-	-	0.8	V	Output OFF mode, I <sub>O</sub> =0mA	Fig.6
Input high level current	I <sub>IN</sub>	100	200	300	μA	CTL=5V, I <sub>O</sub> =0mA	Fig.6

**Regulator ICs**

BA07ST / SFP (unless otherwise noted, Ta=25°C, Vcc=12 V, Io=500 mA) (under development)

Parameter	Symbol	Min.	Typ.	Max.	Unit	Conditions	Measurement circuit
Power save current	I <sub>ST</sub>	-	0	10	μA	OFF mode	Fig.4
Output voltage	V <sub>O1</sub>	6.65	7.0	7.35	V		Fig.1
Input stability	Reg.I	-	20	100	mV	V <sub>CC</sub> =8→25V	Fig.1
Ripple rejection ratio	R.R.	45	55	-	dB	e <sub>IN</sub> =1Vrms, f=120Hz, I <sub>O</sub> =100mA	Fig.2
Load regulation	Reg.L	-	50	150	mV	I <sub>O</sub> =5mA→1A	Fig.1
Temperature coefficient of output voltage	T <sub>CV0</sub>	-	±0.02	-	% / °C	I <sub>O</sub> =5mA, T <sub>J</sub> =0~125°C	Fig.1
Minimum I/O voltage differential	V <sub>d</sub>	-	0.3	0.5	V	V <sub>CC</sub> =6.65V	Fig.3
Bias current	I <sub>b</sub>	-	2.5	5.0	mA	I <sub>O</sub> =0mA	Fig.4
Peak output current	I <sub>O</sub>	1.0	1.5	-	A	T <sub>J</sub> =25°C	Fig.1
Output short-circuit current	I <sub>OS</sub>	-	0.4	-	A	V <sub>CC</sub> =25V	Fig.5
ON mode voltage	V <sub>th1</sub>	2.0	-	-	V	Output Active mode, I <sub>O</sub> =0mA	Fig.6
OFF mode voltage	V <sub>th2</sub>	-	-	0.8	V	Output OFF mode, I <sub>O</sub> =0mA	Fig.6
Input high level current	I <sub>IN</sub>	100	200	300	μA	CTL=5V, I <sub>O</sub> =0mA	Fig.6

BA08ST / SFP (unless otherwise noted, Ta=25°C, Vcc=13 V, Io=500 mA)

Parameter	Symbol	Min.	Typ.	Max.	Unit	Conditions	Measurement circuit
Power save current	I <sub>ST</sub>	-	0	10	μA	OFF mode	Fig.4
Output voltage	V <sub>O1</sub>	7.6	8.0	8.4	V		Fig.1
Input stability	Reg.I	-	20	100	mV	V <sub>CC</sub> 9→25V	Fig.1
Ripple rejection ratio	R.R.	45	55	-	dB	e <sub>IN</sub> =1Vrms, f=120Hz, I <sub>O</sub> =100mA	Fig.2
Load regulation	Reg.L	-	50	150	mV	I <sub>O</sub> =5mA→1A	Fig.1
Temperature coefficient of output voltage	T <sub>CV0</sub>	-	±0.02	-	% / °C	I <sub>O</sub> =5mA, T <sub>J</sub> =0~125°C	Fig.1
Minimum I/O voltage differential	V <sub>d</sub>	-	0.3	0.5	V	V <sub>CC</sub> =0.95V <sub>O</sub>	Fig.3
Bias current	I <sub>b</sub>	-	2.5	5.0	mA	I <sub>O</sub> =0mA	Fig.4
Peak output current	I <sub>O</sub>	1.0	1.5	-	A	T <sub>J</sub> =25°C	Fig.1
Output short-circuit current	I <sub>OS</sub>	-	0.4	-	A	V <sub>CC</sub> =25V	Fig.5
ON mode voltage	V <sub>th1</sub>	2.0	-	-	V	Output Active mode, I <sub>O</sub> =0mA	Fig.6
OFF mode voltage	V <sub>th2</sub>	-	-	0.8	V	Output OFF mode, I <sub>O</sub> =0mA	Fig.6
Input high level current	I <sub>IN</sub>	100	200	300	μA	CTL=5V, I <sub>O</sub> =0mA	Fig.6

BA09ST / SFP (unless otherwise noted, Ta=25°C, Vcc=14 V, Io=500 mA)

Parameter	Symbol	Min.	Typ.	Max.	Unit	Conditions	Measurement circuit
Power save current	I <sub>ST</sub>	-	0	10	μA	OFF mode	Fig.4
Output voltage	V <sub>O1</sub>	8.55	9.0	9.45	V		Fig.1
Input stability	Reg.I	-	20	100	mV	V <sub>CC</sub> =10→25V	Fig.1
Ripple rejection ratio	R.R.	45	55	-	dB	e <sub>IN</sub> =1Vrms, f=120Hz, I <sub>O</sub> =100mA	Fig.2
Load regulation	Reg.L	-	50	150	mV	I <sub>O</sub> =5mA→1A	Fig.1
Temperature coefficient of output voltage	T <sub>CV0</sub>	-	±0.02	-	% / °C	I <sub>O</sub> =5mA, T <sub>J</sub> =0~125°C	Fig.1
Minimum I/O voltage differential	V <sub>d</sub>	-	0.3	0.5	V	V <sub>CC</sub> =0.95V <sub>O</sub>	Fig.3
Bias current	I <sub>b</sub>	-	2.5	5.0	mA	I <sub>O</sub> =0mA	Fig.4
Peak output current	I <sub>O</sub>	1.0	1.5	-	A	T <sub>J</sub> =25°C	Fig.1
Output short-circuit current	I <sub>OS</sub>	-	0.4	-	A	V <sub>CC</sub> =25V	Fig.5
ON mode voltage	V <sub>th1</sub>	2.0	-	-	V	Output Active mode, I <sub>O</sub> =0mA	Fig.6
OFF mode voltage	V <sub>th2</sub>	-	-	0.8	V	Output OFF mode, I <sub>O</sub> =0mA	Fig.6
Input high level current	I <sub>IN</sub>	100	200	300	μA	CTL=5V, I <sub>O</sub> =0mA	Fig.6

## Regulator ICs

BA10ST (unless otherwise noted, Ta=25°C, Vcc=15 V, Io=500 mA)

Parameter	Symbol	Min.	Typ.	Max.	Unit	Conditions	Measurement circuit
Power save current	I <sub>ST</sub>	-	0	10	μA	OFF mode	Fig.4
Output voltage	V <sub>O1</sub>	9.5	10	10.5	V		Fig.1
Input stability	Reg.I	-	20	100	mV	V <sub>CC</sub> =11→25V	Fig.1
Ripple rejection ratio	R.R.	45	55	-	dB	e <sub>IN</sub> =1Vrms, f=120Hz, I <sub>O</sub> =100mA	Fig.2
Load regulation	Reg.L	-	50	150	mV	I <sub>O</sub> =5mA→1A	Fig.1
Temperature coefficient of output voltage	T <sub>CV0</sub>	-	±0.02	-	% / °C	I <sub>O</sub> =5mA, T <sub>J</sub> =0~125°C	Fig.1
Minimum I/O voltage differential	V <sub>d</sub>	-	0.3	0.5	V	V <sub>CC</sub> =0.95V <sub>O</sub>	Fig.3
Bias current	I <sub>b</sub>	-	2.5	5.0	mA	I <sub>O</sub> =0mA	Fig.4
Peak output current	I <sub>O</sub>	1.0	1.5	-	A	T <sub>J</sub> =25°C	Fig.1
Output short-circuit current	I <sub>OS</sub>	-	0.4	-	A	V <sub>CC</sub> =25V	Fig.5
ON mode voltage	V <sub>th1</sub>	2.0	-	-	V	Output Active mode, I <sub>O</sub> =0mA	Fig.6
OFF mode voltage	V <sub>th2</sub>	-	-	0.8	V	Output OFF mode, I <sub>O</sub> =0mA	Fig.6
Input high level current	I <sub>IN</sub>	100	200	300	μA	CTL=5V, I <sub>O</sub> =0mA	Fig.6

BA12ST (unless otherwise noted, Ta=25°C, Vcc=17 V, Io=500 mA)

Parameter	Symbol	Min.	Typ.	Max.	Unit	Conditions	Measurement circuit
Power save current	I <sub>ST</sub>	-	0	10	μA	OFF mode	Fig.4
Output voltage	V <sub>O1</sub>	11.4	12	12.6	V		Fig.1
Input stability	Reg.I	-	20	100	mV	V <sub>CC</sub> =13→25V	Fig.1
Ripple rejection ratio	R.R.	45	55	-	dB	e <sub>IN</sub> =1Vrms, f=120Hz, I <sub>O</sub> =100mA	Fig.2
Load regulation	Reg.L	-	50	150	mV	I <sub>O</sub> =5mA→1A	Fig.1
Temperature coefficient of output voltage	T <sub>CV0</sub>	-	±0.02	-	% / °C	I <sub>O</sub> =5mA, T <sub>J</sub> =0~125°C	Fig.1
Minimum I/O voltage differential	V <sub>d</sub>	-	0.3	0.5	V	V <sub>CC</sub> =0.95V <sub>O</sub>	Fig.3
Bias current	I <sub>b</sub>	-	2.5	5.0	mA	I <sub>O</sub> =0mA	Fig.4
Peak output current	I <sub>O</sub>	1.0	1.5	-	A	T <sub>J</sub> =25°C	Fig.1
Output short-circuit current	I <sub>OS</sub>	-	0.4	-	A	V <sub>CC</sub> =25V	Fig.5
ON mode voltage	V <sub>th1</sub>	2.0	-	-	V	Output Active mode, I <sub>O</sub> =0mA	Fig.6
OFF mode voltage	V <sub>th2</sub>	-	-	0.8	V	Output OFF mode, I <sub>O</sub> =0mA	Fig.6
Input high level current	I <sub>IN</sub>	100	200	300	μA	CTL=5V, I <sub>O</sub> =0mA	Fig.6

## Regulator ICs

### ● Measurement circuits

(The C pin only exists on the BA00AST / ASFP, for the BA00AST / ASFP, place a 6.8kΩ resistor between the OUT and C pins, and a 2.2kΩ resistor between the C and pins.)

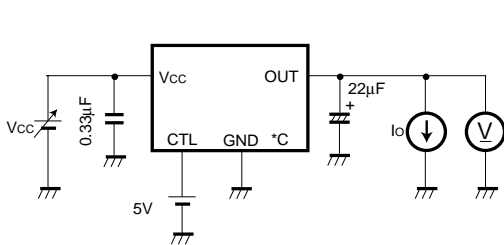
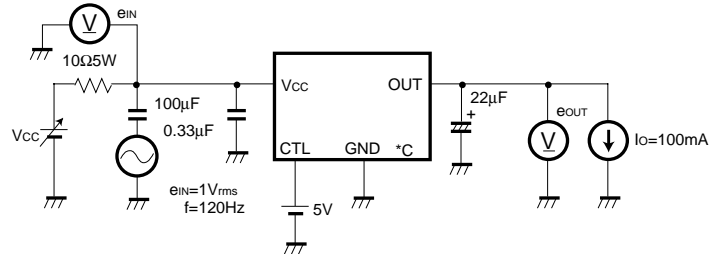

Fig.1 Measurement circuit for output voltage, input stability, load regulation, and temperature coefficient of output voltage



$$\text{Ripple rejection ratio R.R.} = 20 \log \left( \frac{|e_{IN}|}{|e_{OUT}|} \right)$$

Fig.2 Measurement circuit for ripple rejection ratio

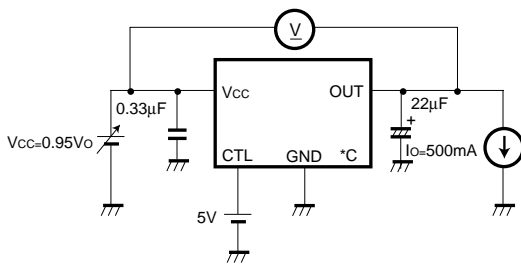

Fig.3 Measurement circuit for minimum I/O voltage differential

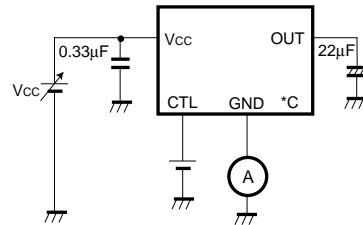

Fig.4 Measurement circuit for bias current, power save current measurement circuit

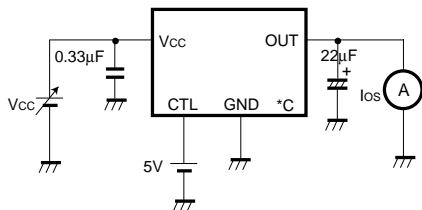

Fig.5 Measurement circuit for output short-circuit current

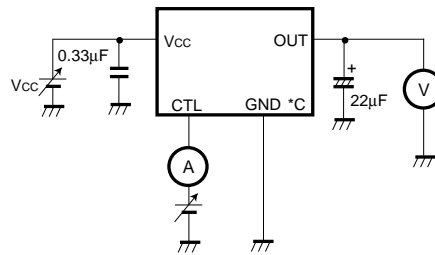

Fig.6 Measurement circuit for ON/OFF mode voltage, input high level current



## Regulator ICs

---

### ●Operation notes

#### (1) Operating power supply voltage

When operating within the normal voltage range and within the ambient operating temperature range, most circuit functions are guaranteed. The rated values cannot be guaranteed for the electrical characteristics, but there are no sudden changes of the characteristics within these ranges.

#### (2) Power dissipation

Heat attenuation characteristics are noted on a separate page and can be used as a guide in judging power dissipation. If these ICs are used in such a way that the allowable power dissipation level is exceeded, an increase in the chip temperature could cause a reduction in the current capability or could otherwise adversely affect the performance of the IC. Make sure a sufficient margin is allowed so that the allowable power dissipation value is not exceeded.

#### (3) Output oscillation prevention and bypass capacitor

Be sure to connect a capacitor between the output pin and GND to prevent oscillation. Since fluctuations in the value of the capacitor due to temperature changes may cause oscillations, a tantalum electrolytic capacitor with a small internal series resistance (ESR) is recommended.

A 22 $\mu$ F capacitor is recommended; however, be aware that if an extremely large capacitance is used (1000 $\mu$ F or greater), then oscillations may occur at low frequencies. Therefore, be sure to perform the appropriate verifications before selecting the capacitor.

Also, we recommend connecting a 0.33 $\mu$ F bypass capacitor as close as possible between the input pin and GND.

#### (4) Current overload protection circuit

A current overload protection circuit is built into the outputs, to prevent IC destruction if the load is shorted.

This protection circuit limits the current in the shape of a fall back characteristics. It is designed with a high margin, so that even if a large current suddenly flows through the large capacitor in the IC, the current is restricted and latching is prevented.

However, these protection circuits are only good for pre-venting damage from sudden accidents. The design should take this into consideration, so that the protection circuit is not made to operate continuously (for instance, clamping at an output of 1V<sub>F</sub> or greater; below 1V<sub>F</sub>, the short mode circuit operates). Note that the capacitor has negative temperature characteristics, and the design should take this into consideration.

#### (5) Thermal overload circuit

A built-in thermal overload circuit prevents damage from overheating. When the thermal circuit is activated, the various outputs are in the OFF state. When the temperature drops back to a constant level, the circuit is restored.

(6) Internal circuits could be damaged if there are modes in which the electric potential of the application's input (V<sub>CC</sub>) and GND are the opposite of the electric potential of the various outputs. Use of a diode or other such bypass path is recommended.

(7) Although the manufacture of this product includes rigorous quality assurance procedures, the product may be damaged if absolute maximum ratings for voltage or operating temperature are exceeded. If damage has occurred, special modes (such as short circuit mode or open circuit mode) cannot be specified. If it is possible that such special modes may be needed, please consider using a fuse or some other mechanical safety measure.

(8) When used within a strong magnetic field, be aware that there is a slight possibility of malfunction.

## Regulator ICs

(9) When the connected load which contains a big inductance component in an output terminal is connected and the occurrence of a reverse electromotive force can be considered at the time of and power-output OFF at the time of starting, I ask the insertion of protection diode of you.

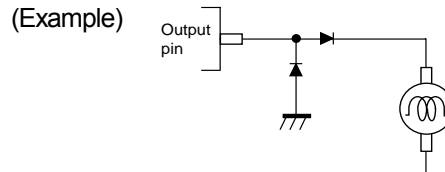

(10) Although it is sure that the example of an application circuit should be recommended, in a usage, I fully ask the validation of a property of you.

In addition, when you alter the circuit constant with outside and you become a usage, please see and decide sufficient margin in consideration of the dispersion in an external component and IC of our company etc. not only including the static characteristic but including a transient characteristic.

This IC is monolithic IC and has P+ isolation and P substrate for an isolation between each element.

A P-N junction is formed by these P layers and N layers of each element, and various kinds of parasitic elements are formed. For example, when the resistor and the transistor are connected with the pin like the example of a simple architecture,

- At a resistor, it is at the time of GND > (PIN A), at a transistor (NPN), it is at the time of GND > (PIN B),

A P-N junction operates as parasitism diode.

- At a transistor (NPN), it is at the time of GND > (PIN B),

The NPN transistor of a parasitic element operates by N layers of other elements which approach with the above-mentioned parasitism diode.

A parasitic element is inevitably made according to a potential relation on the architecture of IC.

When a parasitic element operates, the interference of a circuit operation is caused and the cause of a malfunction, as a result a destructive is obtained.

Therefore, please be fully careful of impressing a voltage lower than GND(P substrate) to an input/output terminal etc. not to carry out usage with which a parasitic element operates.

**Regulator ICs**

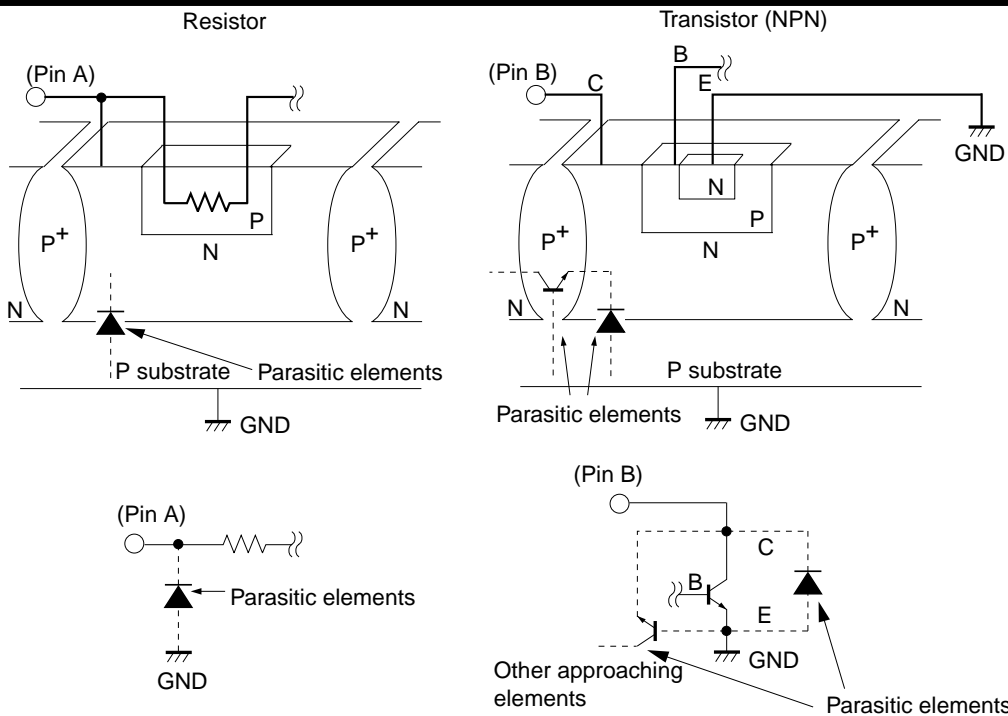

The example of a simple architecture of bipolar IC

**Electrical characteristic curves**

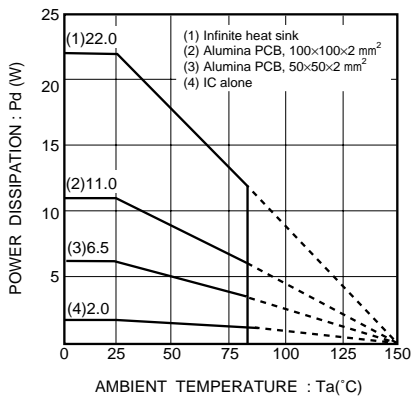

Fig. 7 Thermal derating curves (TO220FP-5)

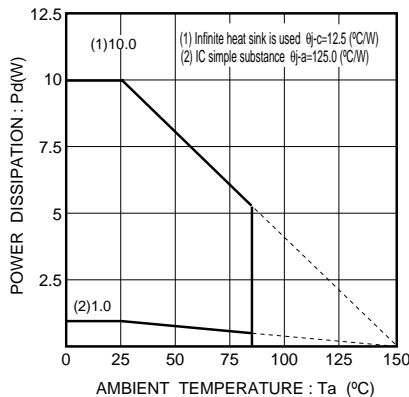

Fig.8 Thermal derating curves (TO252-5)

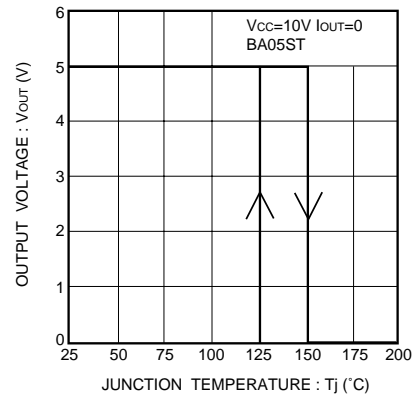

Fig.9 Thermal cutoff circuit characteristics

**Regulator ICs**

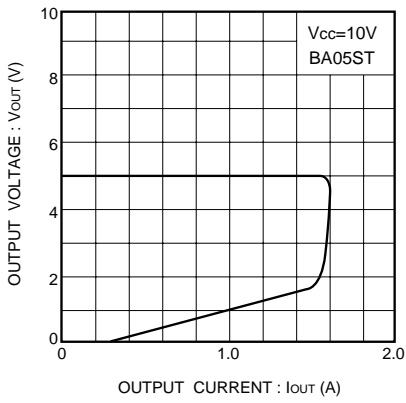

Fig.10 Current limit characteristics

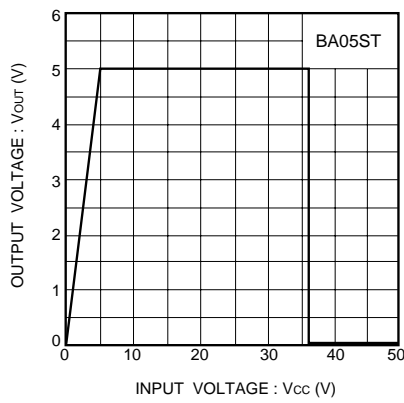

Fig.11 Over voltage protection characteristics

●External Dimensions (Units: mm)

