

Excellent Integrated System Limited

Stocking Distributor

Click to view price, real time Inventory, Delivery & Lifecycle Information:

[Molex Connector Corporation](#)
[51065-1500](#)

For any questions, you can email us directly:

sales@integrated-circuit.com

10 9 8 7 6 5 4 3 2 1

回路番号
CIRCUIT NO.

△ トレードマーク
TRADE MARK

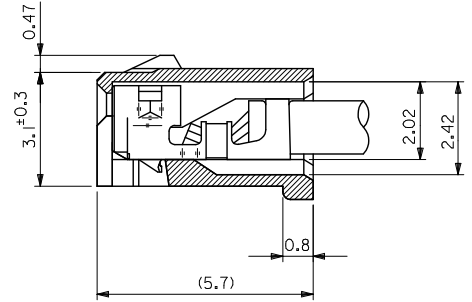
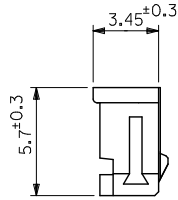
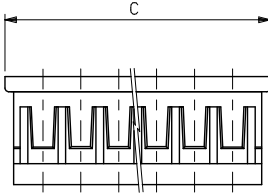
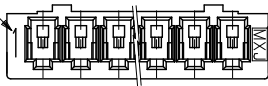

ターミナル装着状態図
TERMINAL ASSEMBLY DRAWING
(10:1)

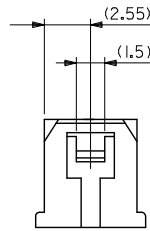
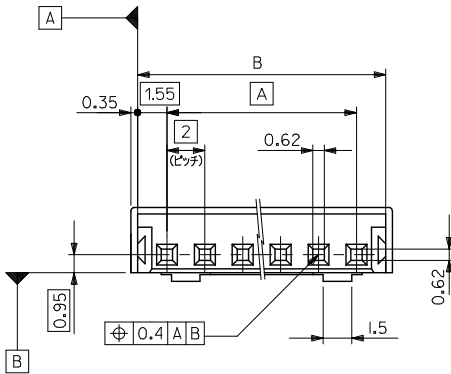

2極の場合
IN CASE OF
2 CIRCUIT HSG.

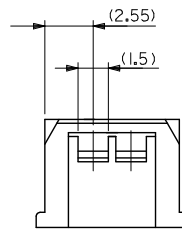

3極の場合
IN CASE OF
3 CIRCUIT HSG.

31.8	31.1	28	51065-150*	15
29.8	29.1	26	-140*	14
27.8	27.1	24	-130*	13
25.8	25.1	22	-120*	12
23.8	23.1	20	-110*	11
21.8	21.1	18	-100*	10
19.8	19.1	16	-090*	9
17.8	17.1	14	-080*	8
15.8	15.1	12	-070*	7
13.8	13.1	10	-060*	6
11.8	11.1	8	-050*	5
9.8	9.1	6	-040*	4
7.8	7.1	4	-030*	3
5.8	5.1	2	51065-020*	2
C	B	A	PLASTIC BAG	極数
			オーダー番号 ORDER NO.	CIRCUITS

CONNECTOR SERIES NO. 51065-**0*

REVISED EC NO. J2014-0578 DRAWN: MAKE CHKD: KAKAWA APPR: NIKITA 2013/09/17 2013/09/17 2013/10/02	GENERAL TOLERANCES (UNLESS SPECIFIED)		DIMENSION STYLE MM ONLY		SCALE 5:1	DESIGN UNITS METRIC	THIRD ANGLE PROJECTION
	10 UNDER	± 0.2	DRAWN BY S. AIHARA	DATE '89/09/21	TITLE NEW 2.0 WIRE TO BOARD CONN RECEPTACLE HOUSING		
	10 OVER 30 UNDER	± 0.25	CHECKED BY M. FUKUSHIMA	DATE '90/01/18	DOCUMENT NO. SD-51065-004		
	30 OVER	± 0.3	APPROVED BY M. ENOMOTO	DATE '90/01/18	SHEET NO. 1 OF 2		
	ANGULAR ± 3 °	DRAFT WHERE APPLICABLE MUST REMAIN WITHIN DIMENSIONS		SEE CHART		THIS DRAWING CONTAINS INFORMATION THAT IS PROPRIETARY TO MOLEX INCORPORATED AND SHOULD NOT BE USED WITHOUT WRITTEN PERMISSION	

9 8 7 6 5 4 3 2

10 9 8 7 6 5 4 3 2 1

注記 NOTES

- 適合ターミナル : 50212 , 50372 シリーズ
APPLICABLE TERMINAL : 50212 , 50372 SERIES
- 適合相手 : 53253 , 53254 シリーズ
MATE WITH : 53253 , 53254 SERIES
- 材質 : PBT , UL94V-0
MATERIAL : PBT , UL94V-0

△ オーダー番号 ORDER NO.

51065-***0*

極数 CIRCUIT SIZE 色番号 COLOR CODE

0	自然色 (白) NATURAL (WHITE)
1	黒 BLACK
2	赤 RED
3	黄 YELLOW
4	青 BLUE
6	緑 GREEN

△ トレードマーク : M プラス1~2 文字の製造工場を示すアルファベットにて構成。但し、"J" は JAPAN を示す。(例 MXJ)
FORMED BY M AND FROM 1 TO 2 MORE LETTER OF ALPHABET WHICH MEAN THE MANUFACTORY. BUT "J" MEANS JAPAN. (TO TRADE MARK) (e.g. MXJ).

31.8	31.1	28						51065-1501	51065-1500	15
29.8	29.1	26						51065-1401	51065-1400	14
27.8	27.1	24						51065-1301	51065-1300	13
25.8	25.1	22							51065-1200	12
23.8	23.1	20							51065-1100	11
21.8	21.1	18							51065-1000	10
19.8	19.1	16							51065-0900	9
17.8	17.1	14							51065-0800	8
15.8	15.1	12			51065-0704				51065-0700	7
13.8	13.1	10				51065-0603	51065-0602		51065-0600	6
11.8	11.1	8							51065-0500	5
9.8	9.1	6				51065-0403	51065-0402		51065-0400	4
7.8	7.1	4			51065-0304		51065-0302	51065-0301	51065-0300	3
5.8	5.1	2	51065-0206	51065-0204	51065-0203	51065-0202	51065-0201	51065-0200		2
C	B	A	GREEN	BLUE	YELLOW	RED	BLACK	NATURAL		極数
										CIRCUITS

△ オーダー番号 ORDER NO.

CONNECTOR SERIES NO. 51065-***0*

REVISED EC NO: J2014-0578 DRAWN: WAKE 2013/09/27 CHK: KASAKAWA 2013/09/27 APP: NUKITA 2013/10/02	GENERAL TOLERANCES (UNLESS SPECIFIED)		DIMENSION STYLE MM ONLY		SCALE 5:1	DESIGN UNITS METRIC	THIRD ANGLE PROJECTION
	10 UNDER	± 0.2	DRAWN BY S. AIHARA	DATE '89/09/21	TITLE NEW 2.0 WIRE TO BOARD CONN RECEPTACLE HOUSING molex		
	10 OVER 30 UNDER	± 0.25	CHECKED BY M. FUKUSHIMA	DATE '90/01/18			
	30 OVER	± 0.3	APPROVED BY M. ENOMOTO	DATE '90/01/18			
ANGULAR	± 3 °	MATERIAL NO.		DOCUMENT NO.	SHEET NO. 2 OF 2		
DRAFT WHERE APPLICABLE MUST REMAIN WITHIN DIMENSIONS		SEE CHART		SD-51065-004			
		SIZE A3		THIS DRAWING CONTAINS INFORMATION THAT IS PROPRIETARY TO MOLEX INCORPORATED AND SHOULD NOT BE USED WITHOUT WRITTEN PERMISSION			

9 8 7 6 5 4 3 2 1

10 9 8 7 6 5 4 3 2 1

HEADER HOUSING ASSEMBLY
53254SERIES

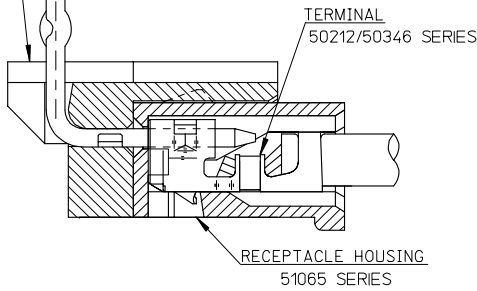

51065シリーズ/53254シリーズ 嵌合状態図 参考
51065 SERIES/53254 SERIES MATED DRAWING (REF.)

HEADER HOUSING ASSEMBLY
53253SERIES

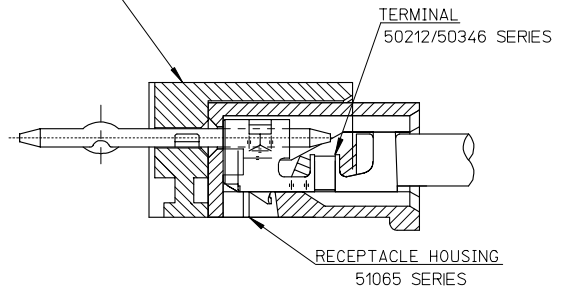

51065シリーズ/53253シリーズ 嵌合状態図 参考
51065 SERIES/53253 SERIES MATED DRAWING (REF.)

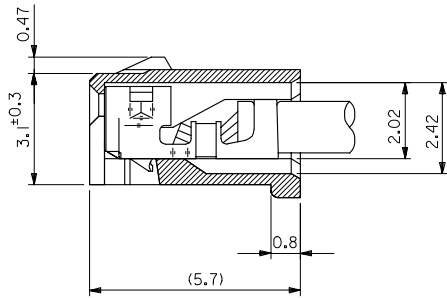

ターミナル装着状態図
TERMINAL ASS'Y DWG.

RELEASED EC NO: J2008-2041 DRAWN BY: AOYAGI CHKD: HARUYAMA APP: NIKITA 2007/11/21 2007/11/22 2007/11/22	GENERAL TOLERANCES (UNLESS SPECIFIED)		DIMENSION STYLE MM ONLY	SCALE 10:1	DESIGN UNITS METRIC	THIRD ANGLE PROJECTION	
	10 UNDER	±0.2	DRAWN BY Y. AOYAGI	DATE 2007/11/13	TITLE NEW 2.0 W/B CONN. 51065/53253OR51065/53254		
	10 OVER 30 UNDER	±0.25	CHECKED BY N. UKITA	DATE 2007/11/13	MOLEX INCORPORATED		
	30 OVER	±0.3	APPROVED BY N. UKITA	DATE 2007/11/13	MATERIAL NO. SEE TABLE	DOCUMENT NO. SD-51065-006	SHEET NO. 1 OF 1
0	DESCRIPTION	ANGULAR ±1°	DRAFT WHERE APPLICABLE MUST REMAIN WITHIN DIMENSIONS				SIZE A3
THIS DRAWING CONTAINS INFORMATION THAT IS PROPRIETARY TO MOLEX INCORPORATED AND SHOULD NOT BE USED WITHOUT WRITTEN PERMISSION							