

## **Excellent Integrated System Limited**

Stocking Distributor

Click to view price, real time Inventory, Delivery & Lifecycle Information:

[Texas Instruments](#)  
[TLV2381IDBVT](#)

For any questions, you can email us directly:

[sales@integrated-circuit.com](mailto:sales@integrated-circuit.com)

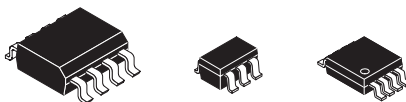

TLV2381  
TLV2382

SLOS377A – SEPTEMBER 2001– REVISED JULY 2003

## FAMILY OF MICROPOWER RAIL-TO-RAIL INPUT AND OUTPUT OPERATIONAL AMPLIFIERS

### FEATURES

- BiMOS Rail-to-Rail Input/Output
- Input Bias Current . . . 1 pA
- High Wide Bandwidth . . . 160 kHz
- High Slew Rate . . . 0.1 V/μs
- Supply Current . . . 7 μA (per channel)
- Input Noise Voltage . . . 90 nV/√Hz
- Supply Voltage Range . . . 2.7 V to 16 V
- Specified Temperature Range
  - –40°C to 125°C . . . Industrial Grade
- Ultra-Small Packaging
  - 5 Pin SOT-23 (TLV2381)

### APPLICATIONS

- Portable Medical
- Power Monitoring
- Low Power Security Detection Systems
- Smoke Detectors

### DESCRIPTION

The TLV238x single supply operational amplifiers provide rail-to-rail input and output capability. The TLV238x takes the minimum operating supply voltage down to 2.7 V over the extended industrial temperature range, while adding the rail-to-rail output swing feature. The TLV238x also provides 160-kHz bandwidth from only 7 μA. The maximum recommended supply voltage is 16 V, which allows the devices to be operated from (±8 V supplies down to ±1.35 V) two rechargeable cells.

The combination of rail-to-rail inputs and outputs make them good upgrades for the TLC27Lx family—offering more bandwidth at a lower quiescent current. The offset voltage is lower than the TLC27LxA variant.

To maintain cost effectiveness the TLV2381/2 are only available in the extended industrial temperature range. This means that one device can be used in a wide range of applications that include PDAs as well as automotive sensor interface.

All members are available in SOIC, with the singles in the small SOT-23 package, duals in the MSOP.

### SELECTION GUIDE

DEVICE	V <sub>S</sub> [V]	I <sub>Q</sub> /ch [μA]	V <sub>ICR</sub> [V]	V <sub>IO</sub> [mV]	I <sub>IB</sub> [pA]	GBW [MHz]	SLEW RATE [V/μs]	V <sub>n</sub> , 1 kHz [nV/√Hz]
TLV238x	2.7 to 16	10	–0.2 to V <sub>S</sub> + 0.2	4.5	60	0.16	0.06	100
TLV27Lx	2.7 to 16	11	–0.2 to V <sub>S</sub> – 1.2	5	60	0.16	0.06	100
TLC27Lx	4 to 16	17	–0.2 to V <sub>S</sub> – 1.5	10/5/2	60	0.085	0.03	68
OPAx349	1.8 to 5.5	2	–0.2 to V <sub>S</sub> + 0.2	10	10	0.070	0.02	300
OPAx347	2.3 to 5.5	34	–0.2 to V <sub>S</sub> + 0.2	6	10	0.35	0.01	60
TLC225x	2.7 to 16	62.5	0 to V <sub>S</sub> – 1.5	1.5/0.85	60	0.200	0.02	19

NOTE: All dc specs are maximums while ac specs are typicals.



Please be aware that an important notice concerning availability, standard warranty, and use in critical applications of Texas Instruments semiconductor products and disclaimers thereto appears at the end of this data sheet.

PRODUCTION DATA information is current as of publication date. Products conform to specifications per the terms of Texas Instruments standard warranty. Production processing does not necessarily include testing of all parameters.

**TLV2381**  
**TLV2382**

SLOS377A – SEPTEMBER 2001– REVISED JULY 2003

**PACKAGE/ORDERING INFORMATION**

PRODUCT	PACKAGE	PACKAGE CODE	SYMBOL	SPECIFIED TEMPERATURE RANGE	ORDER NUMBER	TRANSPORT MEDIA
TLV2381ID	SOIC-8	D	2381I	-40°C to 125°C	TLV2381ID	Tube
					TLV2381IDR	Tape and Reel
TLV2381IDBV	SOT-23	DBV	VBKI		TLV2381IDBVR	Tape and Reel
					TLV2381IDBVT	
TLV2382ID	SOIC-8	D	2382I		TLV2382ID	Tube
					TLV2382IDR	Tape and Reel

**absolute maximum ratings over operating free-air temperature (unless otherwise noted)†**

Supply voltage, $V_S$	16.5 V
Input voltage, $V_I$ (see Notes 1 and 2)	$V_S + 0.2 V$
Output current, $I_O$	100 mA
Differential input voltage, $V_{ID}$	$V_S$
Continuous total power dissipation	See Dissipation Rating Table
Maximum junction temperature, $T_J$	150°C
Operating free-air temperature range, $T_A$ : I suffix	-40°C to 125°C
Storage temperature range, $T_{stg}$	-65°C to 125°C
Lead temperature 1,6 mm (1/16 inch) from case for 10 seconds	300°C

† Stresses beyond those listed under “absolute maximum ratings” may cause permanent damage to the device. These are stress ratings only, and functional operation of the device at these or any other conditions beyond those indicated under “recommended operating conditions” is not implied. Exposure to absolute-maximum-rated conditions for extended periods may affect device reliability.

- NOTES: 1. Relative to GND pin.  
2. Maximum is 16.5 V or  $V_S+0.2 V$  whichever is the lesser value.

**DISSIPATION RATING TABLE**

PACKAGE	$\theta_{JC}$ (°C/W)	$\theta_{JA}$ (°C/W)	$T_A \leq 25^\circ\text{C}$ POWER RATING	$T_A = 85^\circ\text{C}$ POWER RATING
D (8)	38.3	176	710 mW	370 mW
DBV (5)	55	324.1	385 mW	201 mW
DBV (6)	55	294.3	425 mW	221 mW

**recommended operating conditions**

		MIN	MAX	UNIT
Supply voltage, (V <sub>S</sub> )	Dual supply	±1.35	±8	V
	Single supply	2.7	16	
Input common-mode voltage range		-0.2	V <sub>S</sub> +0.2	V
Operating free air temperature, T <sub>A</sub>		-40	125	°C

**electrical characteristics at recommended operating conditions, V<sub>S</sub> = 2.7 V, 5 V, and 15 V (unless otherwise noted)**

**dc performance**

PARAMETER		TEST CONDITIONS		T <sub>A</sub> †	MIN	TYP	MAX	UNIT
V <sub>IO</sub>	Input offset voltage	V <sub>IC</sub> = V <sub>S</sub> /2, R <sub>L</sub> = 100 kΩ	V <sub>O</sub> = V <sub>S</sub> /2 R <sub>S</sub> = 50 Ω	25°C		0.5	4.5	mV
				Full range			6.5	
αV <sub>IO</sub>	Offset voltage drift			25°C		1.1		μV/°C
CMRR	Common-mode rejection ratio	V <sub>IC</sub> = 0 V to V <sub>S</sub> , R <sub>S</sub> = 50 Ω	V <sub>S</sub> = 2.7 V	25°C	54	69	dB	
				Full range	53			
				25°C	71	86		
				Full range	70			
				25°C	58	74		
				Full range	57			
		V <sub>IC</sub> = 0 V to V <sub>S</sub> , R <sub>S</sub> = 50 Ω	V <sub>S</sub> = 5 V	25°C	72	88	dB	
				Full range	70			
				25°C	65	80		
				Full range	64			
				25°C	72	90		
				Full range	70			
V <sub>IC</sub> = 0 V to V <sub>S</sub> , R <sub>S</sub> = 50 Ω	V <sub>S</sub> = 15 V	25°C	80	100	dB			
		Full range	77					
		25°C	80	100				
		Full range	77					
		25°C	77	83				
		Full range	74					
A <sub>VD</sub>	Large-signal differential voltage amplification	V <sub>O(PP)</sub> = V <sub>S</sub> /2, R <sub>L</sub> = 100 kΩ	V <sub>S</sub> = 2.7 V	25°C	80	100	dB	
				Full range	77			
			V <sub>S</sub> = 5 V	25°C	80	100		
				Full range	77			
			V <sub>S</sub> = 15 V	25°C	77	83		
				Full range	74			

† Full range is -40°C to 125°C.

**input characteristics**

PARAMETER		TEST CONDITIONS		T <sub>A</sub>	MIN	TYP	MAX	UNIT
I <sub>IO</sub>	Input offset current	V <sub>IC</sub> = V <sub>S</sub> /2, R <sub>L</sub> = 100 kΩ ,	V <sub>O</sub> = V <sub>S</sub> /2, R <sub>S</sub> = 50 Ω	≤25°C		1	60	pA
				≤70°C			100	
				≤125°C			1000	
I <sub>IB</sub>	Input bias current			≤25°C		1	60	pA
				≤70°C			200	
				≤125°C			1000	
r <sub>i(d)</sub>	Differential input resistance			25°C		1000		GΩ
C <sub>IC</sub>	Common-mode input capacitance	f = 1 kHz		25°C		8		pF

**TLV2381**  
**TLV2382**

SLOS377A – SEPTEMBER 2001– REVISED JULY 2003

**electrical characteristics at recommended operating conditions,  $V_S = 2.7\text{ V}$ ,  $5\text{ V}$ , and  $15\text{ V}$  (unless otherwise noted) (continued)**
**power supply**

PARAMETER		TEST CONDITIONS	$T_A$ †	MIN	TYP	MAX	UNIT
$I_{DD}$	Supply current (per channel)	$V_O = V_S/2$	25°C		7	10	$\mu\text{A}$
			Full range			15	
PSRR	Power supply rejection ratio ( $\Delta V_S/\Delta V_{IO}$ )	$V_S = 2.7\text{ V to }16\text{ V}$ , $V_{IC} = V_S/2\text{ V}$	No load,	25°C	74	82	dB
				Full range	70		

 † Full range is  $-40^\circ\text{C}$  to  $125^\circ\text{C}$  for I suffix.

**output characteristics**

PARAMETER		TEST CONDITIONS	$T_A$ †	MIN	TYP	MAX	UNIT
$V_O$	Output voltage swing from rail	$V_{IC} = V_S/2$ , $I_O = 100\ \mu\text{A}$	$V_S = 2.7\text{ V}$	25°C	200	160	mV
				Full range	220		
			$V_S = 5\text{ V}$	25°C	120	85	
				Full range	200		
		$V_S = 15\text{ V}$	25°C	120	50		
			Full range	150			
		$V_{IC} = V_S/2$ , $I_O = 500\ \mu\text{A}$	$V_S = 5\text{ V}$	25°C	800	420	mV
				Full range	900		
$V_S = 15\text{ V}$	25°C		400	200			
	Full range		500				
$I_O$	Output current	$V_O = 0.5\text{ V from rail}$	$V_S = 2.7\text{ V}$	25°C	400	$\mu\text{A}$	

 † Full range is  $-40^\circ\text{C}$  to  $125^\circ\text{C}$  for I suffix.

**dynamic performance**

PARAMETER		TEST CONDITIONS	$T_A$	MIN	TYP	MAX	UNIT
GBP	Gain bandwidth product	$R_L = 100\ \text{k}\Omega$ , $C_L = 10\ \text{pF}$ , $f = 1\ \text{kHz}$	25°C		160		kHz
SR	Slew rate at unity gain	$V_O(\text{pp}) = 2\ \text{V}$ , $R_L = 100\ \text{k}\Omega$ , $C_L = 10\ \text{pF}$	25°C		0.06		$\text{V}/\mu\text{s}$
			$-40^\circ\text{C}$		0.05		
			125°C		0.08		
$\phi_M$	Phase margin	$R_L = 100\ \text{k}\Omega$ , $C_L = 50\ \text{pF}$	25°C		62		$^\circ$
	Gain margin		25°C		6.7		dB
$t_s$	Settling time (0.1%)	$V(\text{STEP})_{\text{pp}} = 1\ \text{V}$ , $A_V = -1$ , $C_L = 10\ \text{pF}$ , $R_L = 100\ \text{k}\Omega$	25°C	Rise	31		$\mu\text{s}$
				Fall	61		

**noise/distortion performance**

PARAMETER		TEST CONDITIONS	$T_A$	MIN	TYP	MAX	UNIT
$V_n$	Equivalent input noise voltage	$f = 1\ \text{kHz}$	25°C		90		$\text{nV}/\sqrt{\text{Hz}}$

**TYPICAL CHARACTERISTICS**

**Table of Graphs**

			FIGURE
$V_{IO}$	Input offset voltage	vs Common-mode input voltage	1, 2, 3
$I_{IB}/I_{IO}$	Input bias and offset current	vs Free-air temperature	4
$V_{OH}$	High-level output voltage	vs High-level output current	5, 7, 9
$V_{OL}$	Low-level output voltage	vs Low-level output current	6, 8, 10
$I_Q$	Quiescent current	vs Supply voltage	11
		vs Free-air temperature	12
	Supply voltage and supply current ramp up		13
$A_{VD}$	Differential voltage gain and phase shift	vs Frequency	14
GBP	Gain-bandwidth product	vs Free-air temperature	15
$\phi_m$	Phase margin	vs Load capacitance	16
CMRR	Common-mode rejection ratio	vs Frequency	17
PSRR	Power supply rejection ratio	vs Frequency	18
	Input referred noise voltage	vs Frequency	19
SR	Slew rate	vs Free-air temperature	20
$V_{O(PP)}$	Peak-to-peak output voltage	vs Frequency	21
	Inverting small-signal response		22
	Inverting large-signal response		23
	Crosstalk	vs Frequency	24

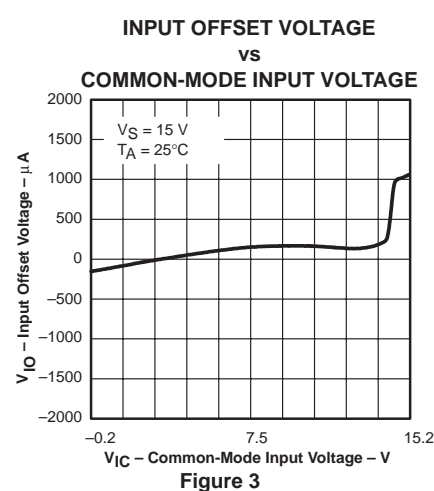
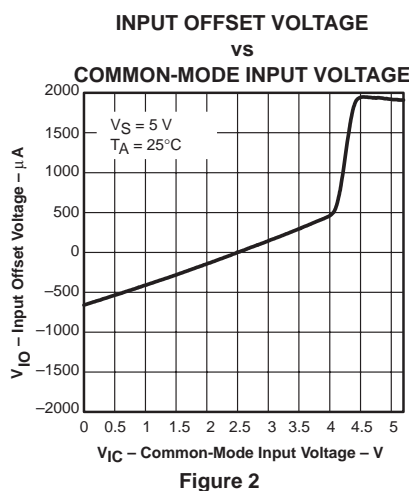
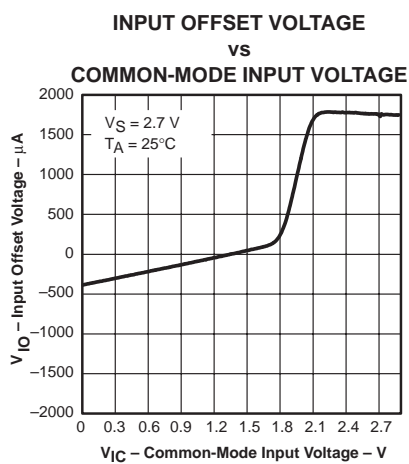

**TLV2381**  
**TLV2382**

SLOS377A – SEPTEMBER 2001– REVISED JULY 2003

**TYPICAL CHARACTERISTICS**

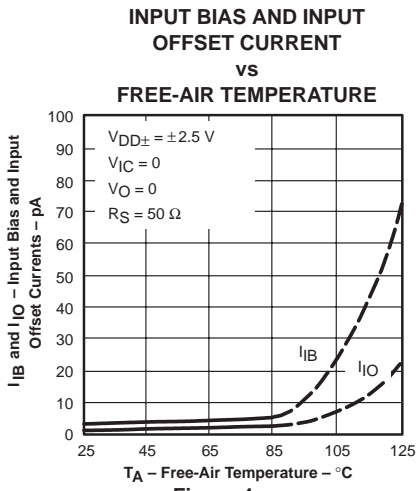

Figure 4

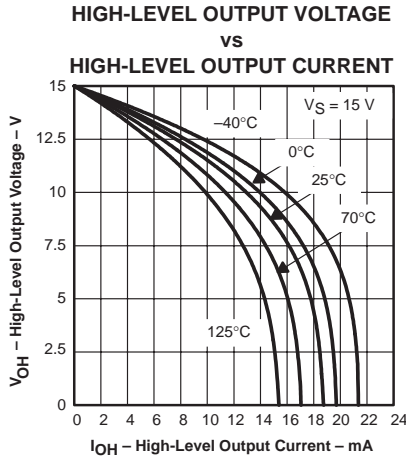

Figure 5

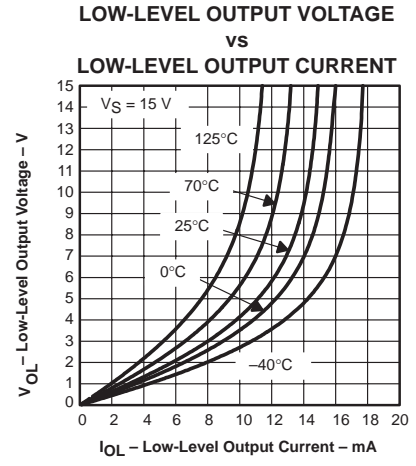

Figure 6

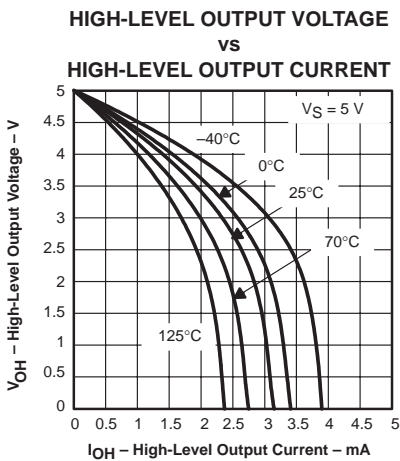

Figure 7

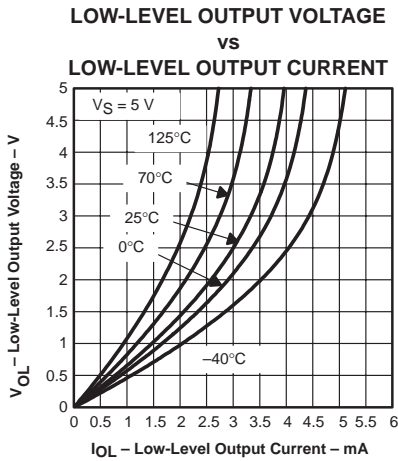

Figure 8

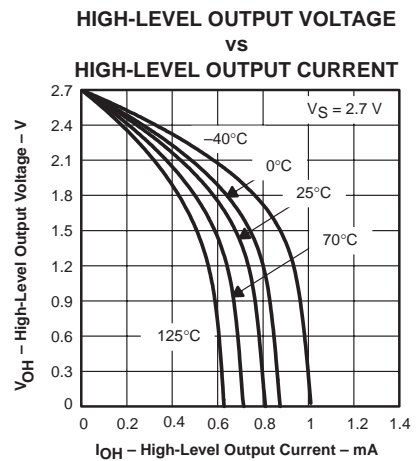

Figure 9

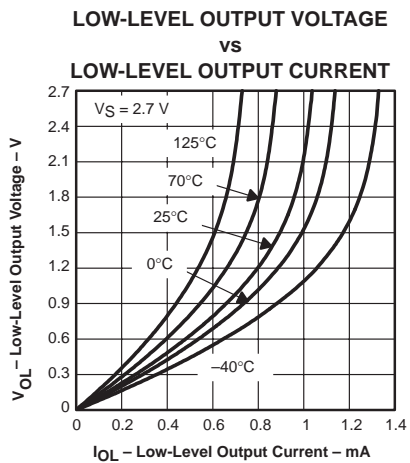

Figure 10

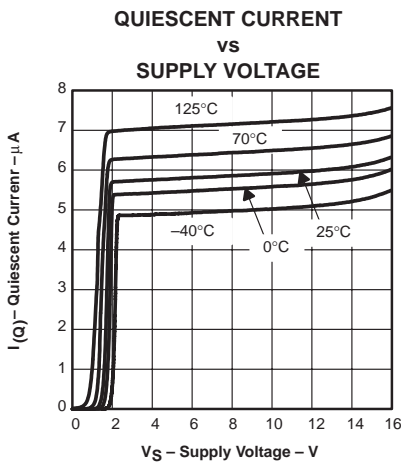

Figure 11

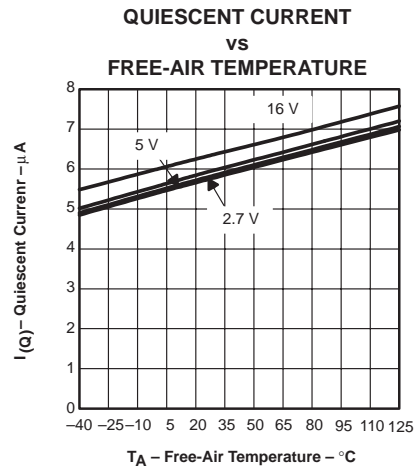

Figure 12

**TYPICAL CHARACTERISTICS**

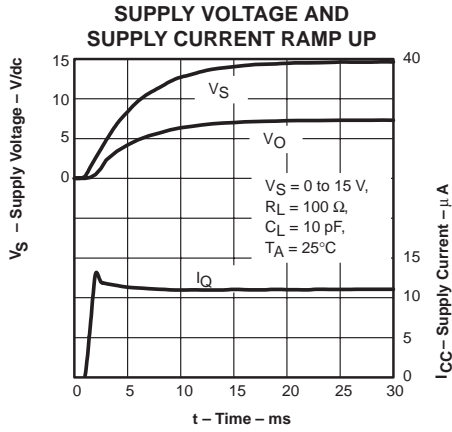

Figure 13

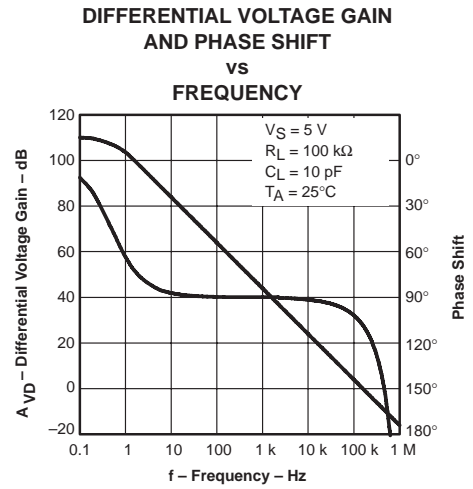

Figure 14

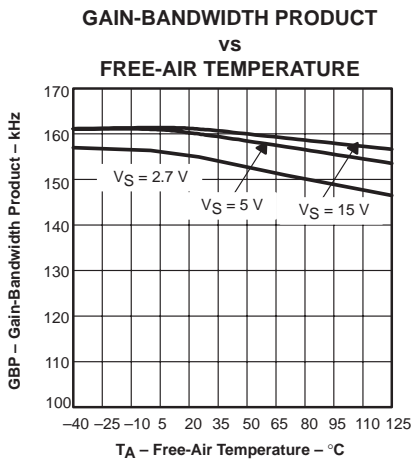

Figure 15

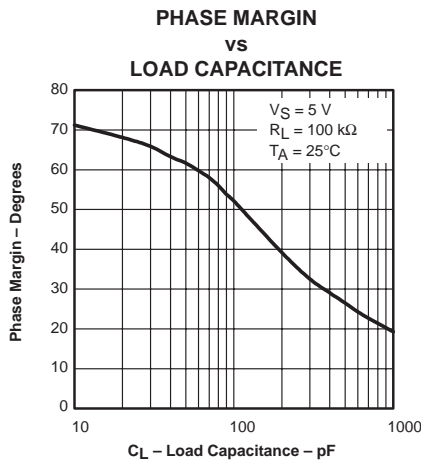

Figure 16

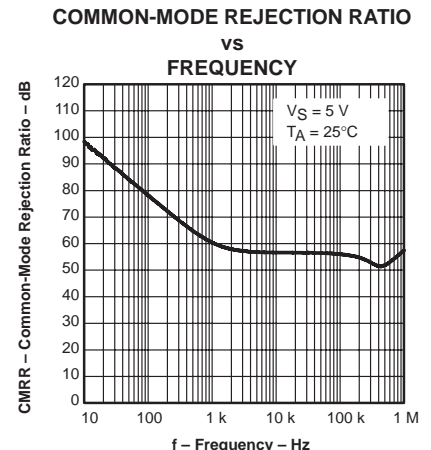

Figure 17

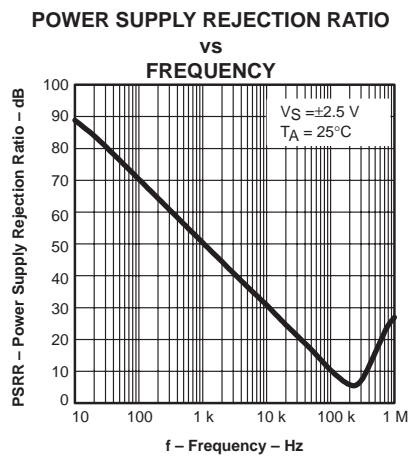

Figure 18

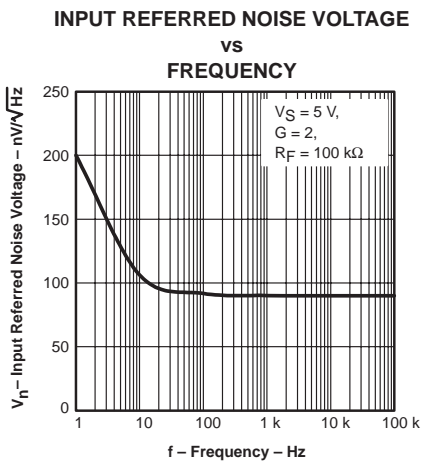

Figure 19

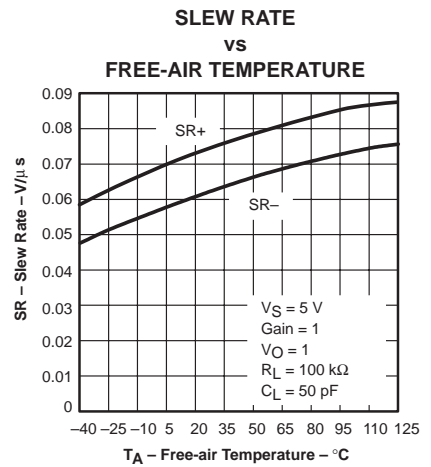

Figure 20



**TLV2381**  
**TLV2382**

SLOS377A – SEPTEMBER 2001– REVISED JULY 2003

**TYPICAL CHARACTERISTICS**

**PEAK-TO-PEAK OUTPUT VOLTAGE  
vs  
FREQUENCY**

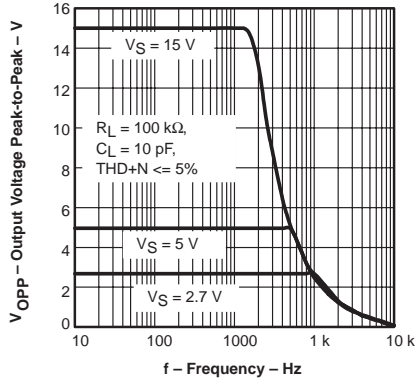

**Figure 21**

**INVERTING SMALL-SIGNAL  
RESPONSE**

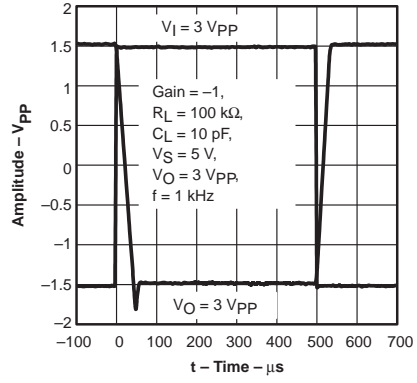

**Figure 22**

**INVERTING LARGE-SIGNAL  
RESPONSE**

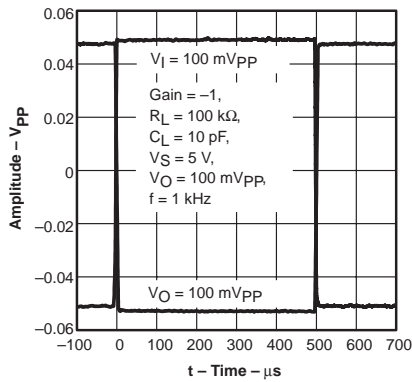

**Figure 23**

**CROSSTALK  
vs  
FREQUENCY**

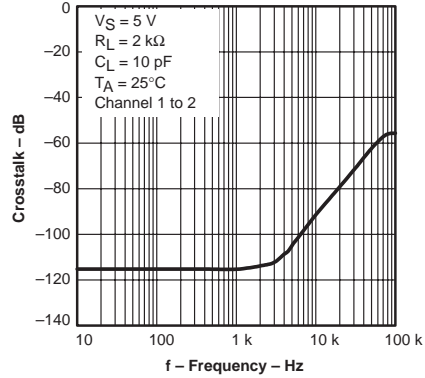
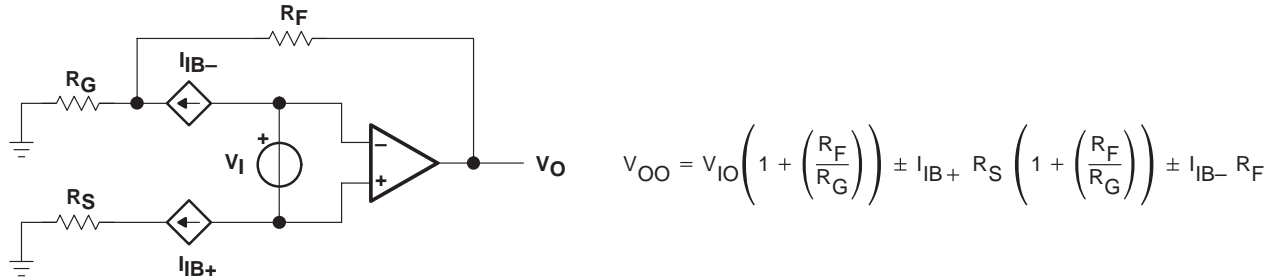

**Figure 24**

**APPLICATION INFORMATION**

**offset voltage**

The output offset voltage ( $V_{OO}$ ) is the sum of the input offset voltage ( $V_{IO}$ ) and both input bias currents ( $I_{IB}$ ) times the corresponding gains. The following schematic and formula can be used to calculate the output offset voltage:



**Figure 25. Output Offset Voltage Model**

**general configurations**

When receiving low-level signals, limiting the bandwidth of the incoming signals into the system is often required. The simplest way to accomplish this is to place an RC filter at the noninverting terminal of the amplifier (see Figure 26).

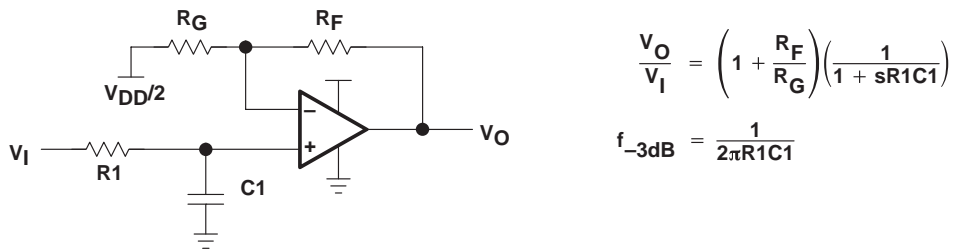

**Figure 26. Single-Pole Low-Pass Filter**

If even more attenuation is needed, a multiple pole filter is required. The Sallen-Key filter can be used for this task. For best results, the amplifier should have a bandwidth that is 8 to 10 times the filter frequency bandwidth. Failure to do this can result in phase shift of the amplifier.

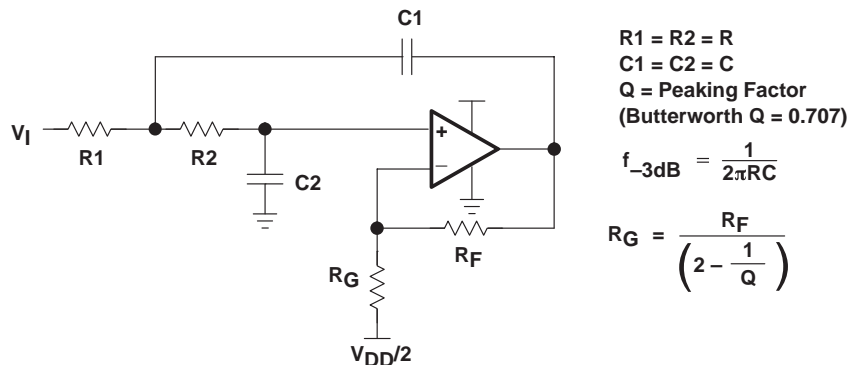

**Figure 27. 2-Pole Low-Pass Sallen-Key Filter**

**TLV2381**  
**TLV2382**

SLOS377A – SEPTEMBER 2001– REVISED JULY 2003

**APPLICATION INFORMATION****circuit layout considerations**

To achieve the levels of high performance of the TLV238x, follow proper printed-circuit board design techniques. A general set of guidelines is given in the following.

- Ground planes—It is highly recommended that a ground plane be used on the board to provide all components with a low inductive ground connection. However, in the areas of the amplifier inputs and output, the ground plane can be removed to minimize the stray capacitance.
- Proper power supply decoupling—Use a 6.8- $\mu$ F tantalum capacitor in parallel with a 0.1- $\mu$ F ceramic capacitor on each supply terminal. It may be possible to share the tantalum among several amplifiers depending on the application, but a 0.1- $\mu$ F ceramic capacitor should always be used on the supply terminal of every amplifier. In addition, the 0.1- $\mu$ F capacitor should be placed as close as possible to the supply terminal. As this distance increases, the inductance in the connecting trace makes the capacitor less effective. The designer should strive for distances of less than 0.1 inches between the device power terminals and the ceramic capacitors.
- Sockets—Sockets can be used but are not recommended. The additional lead inductance in the socket pins will often lead to stability problems. Surface-mount packages soldered directly to the printed-circuit board is the best implementation.
- Short trace runs/compact part placements—Optimum high performance is achieved when stray series inductance has been minimized. To realize this, the circuit layout should be made as compact as possible, thereby minimizing the length of all trace runs. Particular attention should be paid to the inverting input of the amplifier. Its length should be kept as short as possible. This will help to minimize stray capacitance at the input of the amplifier.
- Surface-mount passive components—Using surface-mount passive components is recommended for high performance amplifier circuits for several reasons. First, because of the extremely low lead inductance of surface-mount components, the problem with stray series inductance is greatly reduced. Second, the small size of surface-mount components naturally leads to a more compact layout thereby minimizing both stray inductance and capacitance. If leaded components are used, it is recommended that the lead lengths be kept as short as possible.

**APPLICATION INFORMATION**

**general power dissipation considerations**

For a given  $\theta_{JA}$ , the maximum power dissipation is shown in Figure 28 and is calculated by the following formula:

$$P_D = \left( \frac{T_{MAX} - T_A}{\theta_{JA}} \right)$$

Where:

- $P_D$  = Maximum power dissipation of TLV238x IC (watts)
- $T_{MAX}$  = Absolute maximum junction temperature (150°C)
- $T_A$  = Free-ambient air temperature (°C)
- $\theta_{JA}$  =  $\theta_{JC} + \theta_{CA}$
- $\theta_{JC}$  = Thermal coefficient from junction to case
- $\theta_{CA}$  = Thermal coefficient from case to ambient air (°C/W)

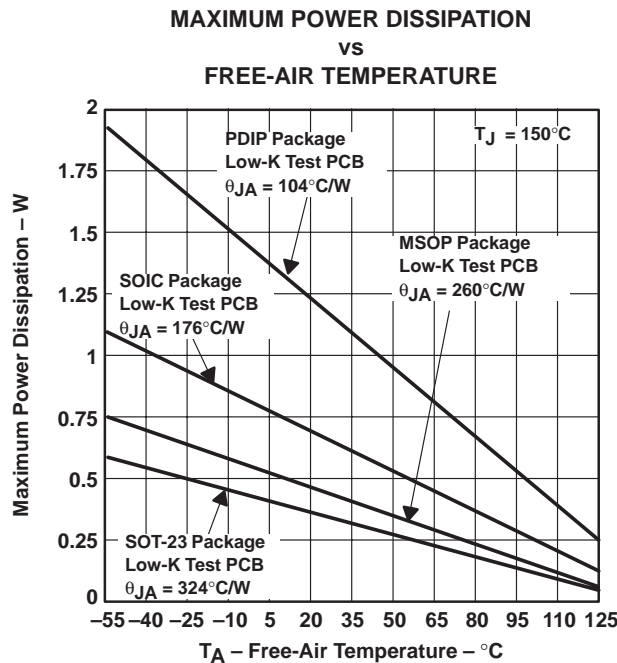

NOTE A: Results are with no air flow and using JEDEC Standard Low-K test PCB.

**Figure 28. Maximum Power Dissipation vs Free-Air Temperature**

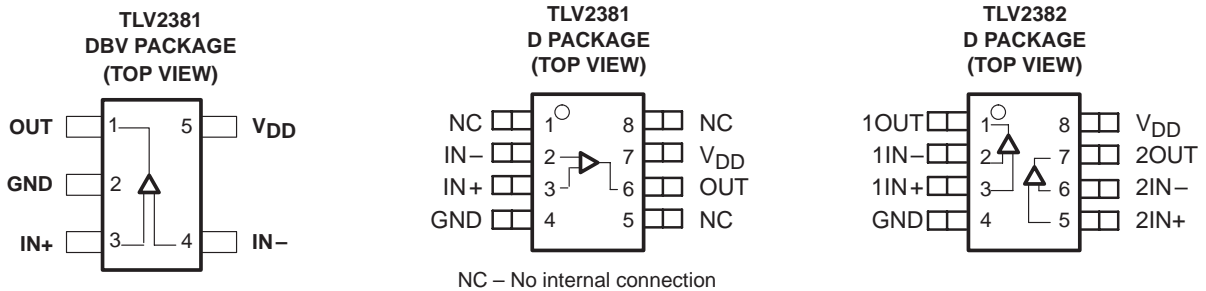

**PACKAGING INFORMATION**

Orderable Device	Status (1)	Package Type	Package Drawing	Pins	Package Qty	Eco Plan (2)	Lead/Ball Finish (6)	MSL Peak Temp (3)	Op Temp (°C)	Device Marking (4/5)	Samples
TLV2381ID	ACTIVE	SOIC	D	8	75	Green (RoHS & no Sb/Br)	CU NIPDAU	Level-1-260C-UNLIM	-40 to 125	23811	<a href="#">Samples</a>
TLV2381IDBVR	ACTIVE	SOT-23	DBV	5	3000	Green (RoHS & no Sb/Br)	CU NIPDAU	Level-1-260C-UNLIM	-40 to 125	VBKI	<a href="#">Samples</a>
TLV2381IDBVRG4	ACTIVE	SOT-23	DBV	5	3000	Green (RoHS & no Sb/Br)	CU NIPDAU	Level-1-260C-UNLIM	-40 to 125	VBKI	<a href="#">Samples</a>
TLV2381IDBVT	ACTIVE	SOT-23	DBV	5	250	Green (RoHS & no Sb/Br)	CU NIPDAU	Level-1-260C-UNLIM	-40 to 125	VBKI	<a href="#">Samples</a>
TLV2381IDBVTG4	ACTIVE	SOT-23	DBV	5	250	Green (RoHS & no Sb/Br)	CU NIPDAU	Level-1-260C-UNLIM	-40 to 125	VBKI	<a href="#">Samples</a>
TLV2381IDG4	ACTIVE	SOIC	D	8	75	Green (RoHS & no Sb/Br)	CU NIPDAU	Level-1-260C-UNLIM	-40 to 125	23811	<a href="#">Samples</a>
TLV2381IDR	ACTIVE	SOIC	D	8	2500	Green (RoHS & no Sb/Br)	CU NIPDAU	Level-1-260C-UNLIM	-40 to 125	23811	<a href="#">Samples</a>
TLV2381IP	PREVIEW	PDIP	P	8		TBD	Call TI	Call TI	-40 to 125		
TLV2382ID	ACTIVE	SOIC	D	8	75	Green (RoHS & no Sb/Br)	CU NIPDAU	Level-1-260C-UNLIM	-40 to 125	23821	<a href="#">Samples</a>
TLV2382IDG4	ACTIVE	SOIC	D	8	75	Green (RoHS & no Sb/Br)	CU NIPDAU	Level-1-260C-UNLIM	-40 to 125	23821	<a href="#">Samples</a>
TLV2382IDR	ACTIVE	SOIC	D	8	2500	Green (RoHS & no Sb/Br)	CU NIPDAU	Level-1-260C-UNLIM	-40 to 125	23821	<a href="#">Samples</a>
TLV2382IDRG4	ACTIVE	SOIC	D	8	2500	Green (RoHS & no Sb/Br)	CU NIPDAU	Level-1-260C-UNLIM	-40 to 125	23821	<a href="#">Samples</a>
TLV2382IP	OBSOLETE	PDIP	P	8		TBD	Call TI	Call TI	-40 to 125		

(1) The marketing status values are defined as follows:

**ACTIVE:** Product device recommended for new designs.

**LIFEBUY:** TI has announced that the device will be discontinued, and a lifetime-buy period is in effect.

**NRND:** Not recommended for new designs. Device is in production to support existing customers, but TI does not recommend using this part in a new design.

**PREVIEW:** Device has been announced but is not in production. Samples may or may not be available.

**OBSOLETE:** TI has discontinued the production of the device.

(2) Eco Plan - The planned eco-friendly classification: Pb-Free (RoHS), Pb-Free (RoHS Exempt), or Green (RoHS & no Sb/Br) - please check <http://www.ti.com/productcontent> for the latest availability information and additional product content details.

**TBD:** The Pb-Free/Green conversion plan has not been defined.



**Pb-Free (RoHS):** TI's terms "Lead-Free" or "Pb-Free" mean semiconductor products that are compatible with the current RoHS requirements for all 6 substances, including the requirement that lead not exceed 0.1% by weight in homogeneous materials. Where designed to be soldered at high temperatures, TI Pb-Free products are suitable for use in specified lead-free processes.

**Pb-Free (RoHS Exempt):** This component has a RoHS exemption for either 1) lead-based flip-chip solder bumps used between the die and package, or 2) lead-based die adhesive used between the die and leadframe. The component is otherwise considered Pb-Free (RoHS compatible) as defined above.

**Green (RoHS & no Sb/Br):** TI defines "Green" to mean Pb-Free (RoHS compatible), and free of Bromine (Br) and Antimony (Sb) based flame retardants (Br or Sb do not exceed 0.1% by weight in homogeneous material)

<sup>(3)</sup> MSL, Peak Temp. - The Moisture Sensitivity Level rating according to the JEDEC industry standard classifications, and peak solder temperature.

<sup>(4)</sup> There may be additional marking, which relates to the logo, the lot trace code information, or the environmental category on the device.

<sup>(5)</sup> Multiple Device Markings will be inside parentheses. Only one Device Marking contained in parentheses and separated by a "-" will appear on a device. If a line is indented then it is a continuation of the previous line and the two combined represent the entire Device Marking for that device.

<sup>(6)</sup> Lead/Ball Finish - Orderable Devices may have multiple material finish options. Finish options are separated by a vertical ruled line. Lead/Ball Finish values may wrap to two lines if the finish value exceeds the maximum column width.

**Important Information and Disclaimer:** The information provided on this page represents TI's knowledge and belief as of the date that it is provided. TI bases its knowledge and belief on information provided by third parties, and makes no representation or warranty as to the accuracy of such information. Efforts are underway to better integrate information from third parties. TI has taken and continues to take reasonable steps to provide representative and accurate information but may not have conducted destructive testing or chemical analysis on incoming materials and chemicals. TI and TI suppliers consider certain information to be proprietary, and thus CAS numbers and other limited information may not be available for release.

In no event shall TI's liability arising out of such information exceed the total purchase price of the TI part(s) at issue in this document sold by TI to Customer on an annual basis.

**TAPE AND REEL INFORMATION**

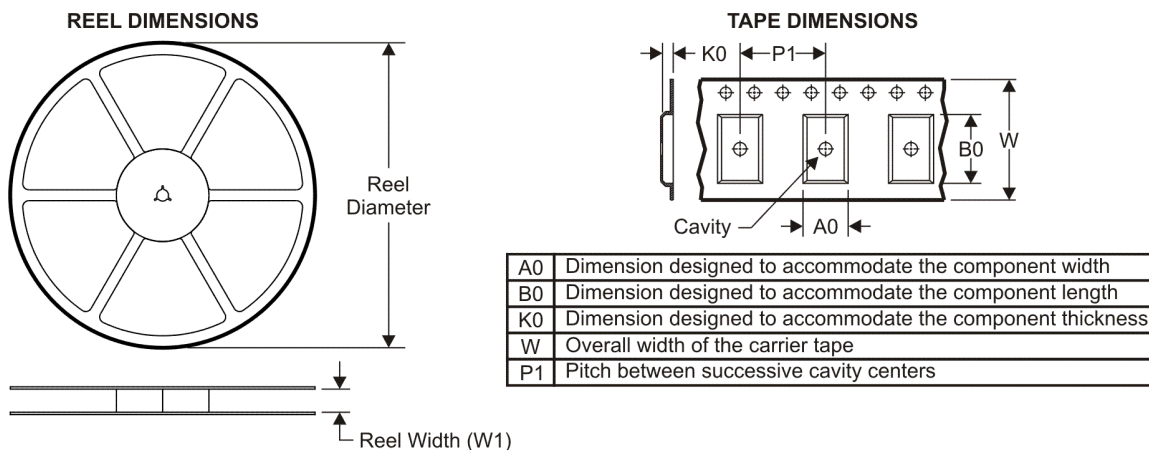

**QUADRANT ASSIGNMENTS FOR PIN 1 ORIENTATION IN TAPE**

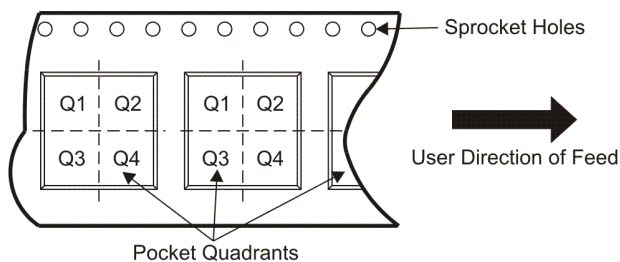

\*All dimensions are nominal

Device	Package Type	Package Drawing	Pins	SPQ	Reel Diameter (mm)	Reel Width W1 (mm)	A0 (mm)	B0 (mm)	K0 (mm)	P1 (mm)	W (mm)	Pin1 Quadrant
TLV2381IDBVR	SOT-23	DBV	5	3000	180.0	9.0	3.15	3.2	1.4	4.0	8.0	Q3
TLV2381IDBVT	SOT-23	DBV	5	250	180.0	9.0	3.15	3.2	1.4	4.0	8.0	Q3
TLV2381IDR	SOIC	D	8	2500	330.0	12.4	6.4	5.2	2.1	8.0	12.0	Q1
TLV2382IDR	SOIC	D	8	2500	330.0	12.4	6.4	5.2	2.1	8.0	12.0	Q1

**TAPE AND REEL BOX DIMENSIONS**

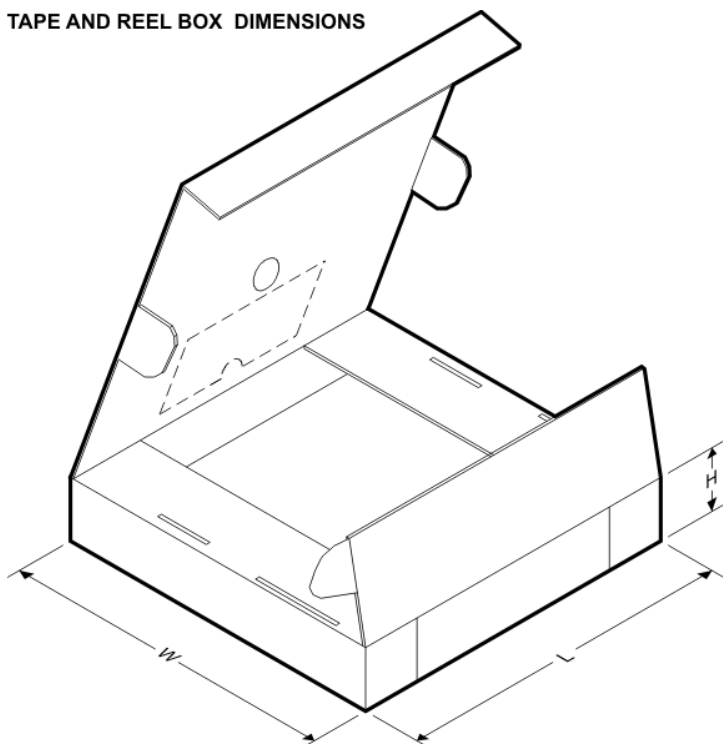

\*All dimensions are nominal

Device	Package Type	Package Drawing	Pins	SPQ	Length (mm)	Width (mm)	Height (mm)
TLV2381IDBVR	SOT-23	DBV	5	3000	182.0	182.0	20.0
TLV2381IDBVT	SOT-23	DBV	5	250	182.0	182.0	20.0
TLV2381IDR	SOIC	D	8	2500	340.5	338.1	20.6
TLV2382IDR	SOIC	D	8	2500	340.5	338.1	20.6



**MECHANICAL DATA**

P (R-PDIP-T8)

PLASTIC DUAL-IN-LINE PACKAGE

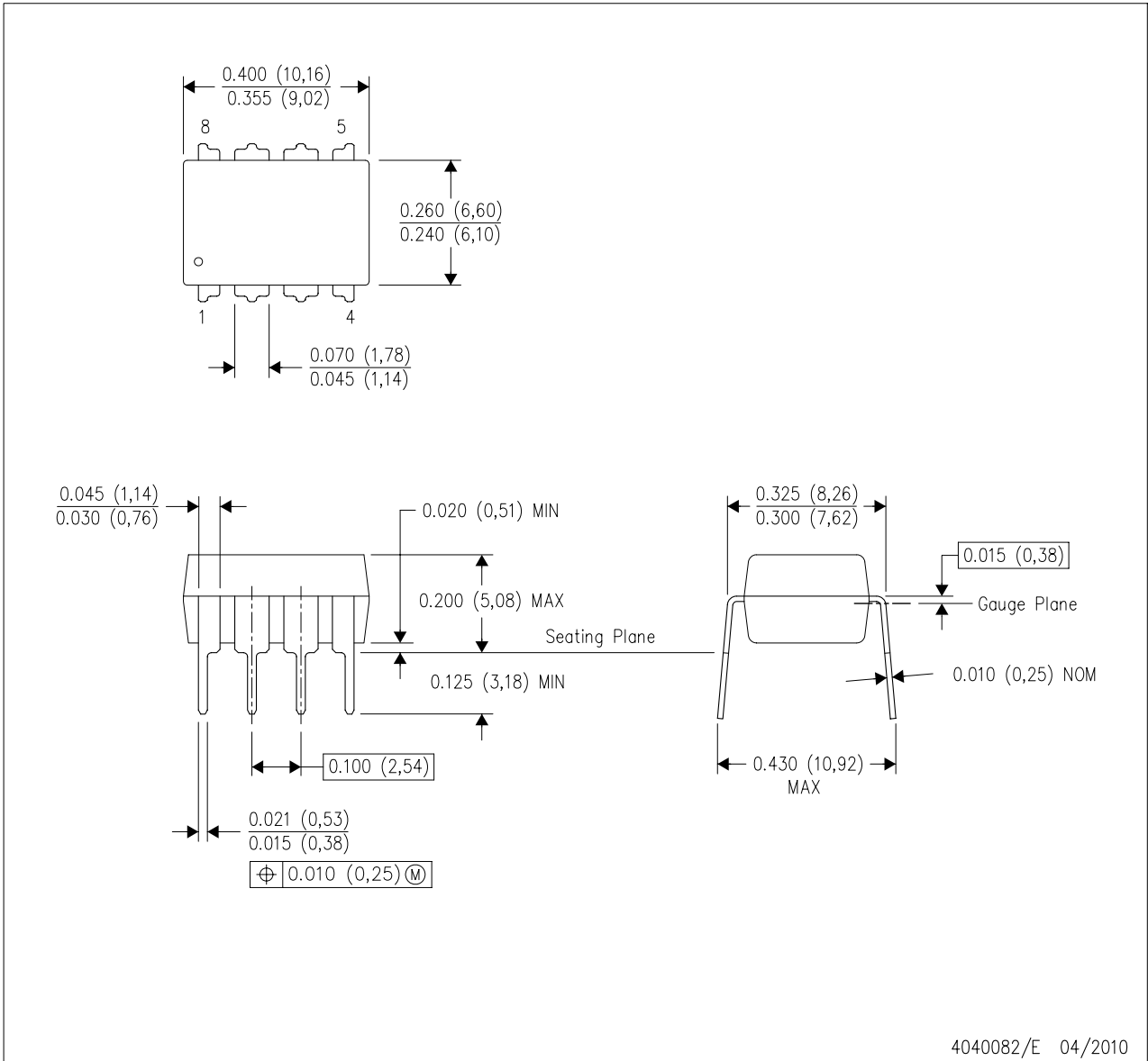

- NOTES:
- A. All linear dimensions are in inches (millimeters).
  - B. This drawing is subject to change without notice.
  - C. Falls within JEDEC MS-001 variation BA.

**MECHANICAL DATA**

DBV (R-PDSO-G5)

PLASTIC SMALL-OUTLINE PACKAGE

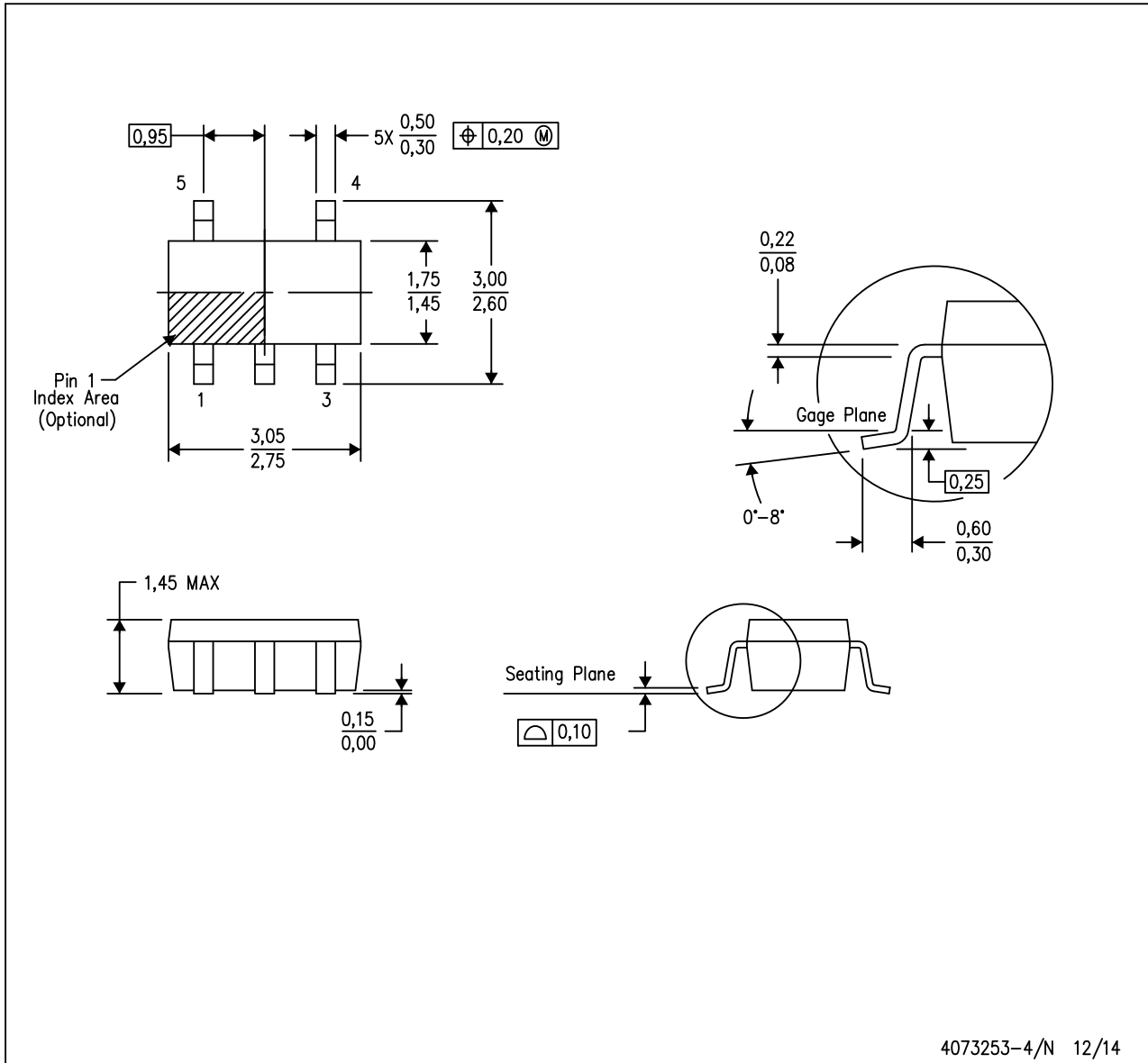

- NOTES:
- A. All linear dimensions are in millimeters.
  - B. This drawing is subject to change without notice.
  - C. Body dimensions do not include mold flash or protrusion. Mold flash and protrusion shall not exceed 0.15 per side.
  - D. Falls within JEDEC MO-178 Variation AA.



**LAND PATTERN DATA**

D (R-PDSO-G8)

PLASTIC SMALL OUTLINE

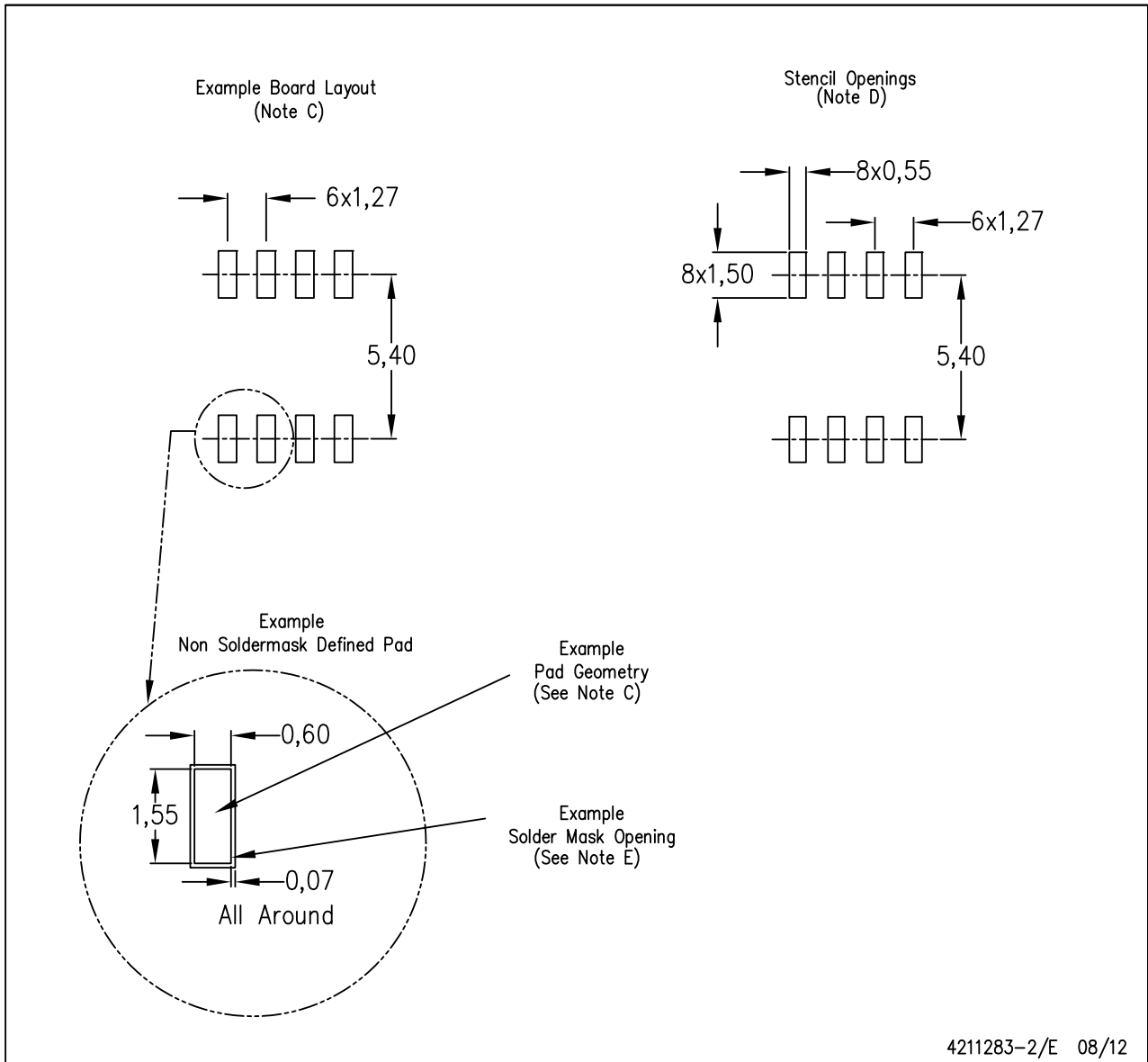

4211283-2/E 08/12

- NOTES:
- A. All linear dimensions are in millimeters.
  - B. This drawing is subject to change without notice.
  - C. Publication IPC-7351 is recommended for alternate designs.
  - D. Laser cutting apertures with trapezoidal walls and also rounding corners will offer better paste release. Customers should contact their board assembly site for stencil design recommendations. Refer to IPC-7525 for other stencil recommendations.
  - E. Customers should contact their board fabrication site for solder mask tolerances between and around signal pads.

## IMPORTANT NOTICE

Texas Instruments Incorporated and its subsidiaries (TI) reserve the right to make corrections, enhancements, improvements and other changes to its semiconductor products and services per JESD46, latest issue, and to discontinue any product or service per JESD48, latest issue. Buyers should obtain the latest relevant information before placing orders and should verify that such information is current and complete. All semiconductor products (also referred to herein as “components”) are sold subject to TI’s terms and conditions of sale supplied at the time of order acknowledgment.

TI warrants performance of its components to the specifications applicable at the time of sale, in accordance with the warranty in TI’s terms and conditions of sale of semiconductor products. Testing and other quality control techniques are used to the extent TI deems necessary to support this warranty. Except where mandated by applicable law, testing of all parameters of each component is not necessarily performed.

TI assumes no liability for applications assistance or the design of Buyers’ products. Buyers are responsible for their products and applications using TI components. To minimize the risks associated with Buyers’ products and applications, Buyers should provide adequate design and operating safeguards.

TI does not warrant or represent that any license, either express or implied, is granted under any patent right, copyright, mask work right, or other intellectual property right relating to any combination, machine, or process in which TI components or services are used. Information published by TI regarding third-party products or services does not constitute a license to use such products or services or a warranty or endorsement thereof. Use of such information may require a license from a third party under the patents or other intellectual property of the third party, or a license from TI under the patents or other intellectual property of TI.

Reproduction of significant portions of TI information in TI data books or data sheets is permissible only if reproduction is without alteration and is accompanied by all associated warranties, conditions, limitations, and notices. TI is not responsible or liable for such altered documentation. Information of third parties may be subject to additional restrictions.

Resale of TI components or services with statements different from or beyond the parameters stated by TI for that component or service voids all express and any implied warranties for the associated TI component or service and is an unfair and deceptive business practice. TI is not responsible or liable for any such statements.

Buyer acknowledges and agrees that it is solely responsible for compliance with all legal, regulatory and safety-related requirements concerning its products, and any use of TI components in its applications, notwithstanding any applications-related information or support that may be provided by TI. Buyer represents and agrees that it has all the necessary expertise to create and implement safeguards which anticipate dangerous consequences of failures, monitor failures and their consequences, lessen the likelihood of failures that might cause harm and take appropriate remedial actions. Buyer will fully indemnify TI and its representatives against any damages arising out of the use of any TI components in safety-critical applications.

In some cases, TI components may be promoted specifically to facilitate safety-related applications. With such components, TI’s goal is to help enable customers to design and create their own end-product solutions that meet applicable functional safety standards and requirements. Nonetheless, such components are subject to these terms.

No TI components are authorized for use in FDA Class III (or similar life-critical medical equipment) unless authorized officers of the parties have executed a special agreement specifically governing such use.

Only those TI components which TI has specifically designated as military grade or “enhanced plastic” are designed and intended for use in military/aerospace applications or environments. Buyer acknowledges and agrees that any military or aerospace use of TI components which have **not** been so designated is solely at the Buyer’s risk, and that Buyer is solely responsible for compliance with all legal and regulatory requirements in connection with such use.

TI has specifically designated certain components as meeting ISO/TS16949 requirements, mainly for automotive use. In any case of use of non-designated products, TI will not be responsible for any failure to meet ISO/TS16949.

### Products

Audio	<a href="http://www.ti.com/audio">www.ti.com/audio</a>
Amplifiers	<a href="http://amplifier.ti.com">amplifier.ti.com</a>
Data Converters	<a href="http://dataconverter.ti.com">dataconverter.ti.com</a>
DLP® Products	<a href="http://www.dlp.com">www.dlp.com</a>
DSP	<a href="http://dsp.ti.com">dsp.ti.com</a>
Clocks and Timers	<a href="http://www.ti.com/clocks">www.ti.com/clocks</a>
Interface	<a href="http://interface.ti.com">interface.ti.com</a>
Logic	<a href="http://logic.ti.com">logic.ti.com</a>
Power Mgmt	<a href="http://power.ti.com">power.ti.com</a>
Microcontrollers	<a href="http://microcontroller.ti.com">microcontroller.ti.com</a>
RFID	<a href="http://www.ti-rfid.com">www.ti-rfid.com</a>
OMAP Applications Processors	<a href="http://www.ti.com/omap">www.ti.com/omap</a>
Wireless Connectivity	<a href="http://www.ti.com/wirelessconnectivity">www.ti.com/wirelessconnectivity</a>

### Applications

Automotive and Transportation	<a href="http://www.ti.com/automotive">www.ti.com/automotive</a>
Communications and Telecom	<a href="http://www.ti.com/communications">www.ti.com/communications</a>
Computers and Peripherals	<a href="http://www.ti.com/computers">www.ti.com/computers</a>
Consumer Electronics	<a href="http://www.ti.com/consumer-apps">www.ti.com/consumer-apps</a>
Energy and Lighting	<a href="http://www.ti.com/energy">www.ti.com/energy</a>
Industrial	<a href="http://www.ti.com/industrial">www.ti.com/industrial</a>
Medical	<a href="http://www.ti.com/medical">www.ti.com/medical</a>
Security	<a href="http://www.ti.com/security">www.ti.com/security</a>
Space, Avionics and Defense	<a href="http://www.ti.com/space-avionics-defense">www.ti.com/space-avionics-defense</a>
Video and Imaging	<a href="http://www.ti.com/video">www.ti.com/video</a>

### TI E2E Community

[e2e.ti.com](http://e2e.ti.com)