

## Excellent Integrated System Limited

Stocking Distributor

Click to view price, real time Inventory, Delivery & Lifecycle Information:

[Sharp Microelectronics](#)  
[GW5SMB30P0C](#)

For any questions, you can email us directly:

[sales@integrated-circuit.com](mailto:sales@integrated-circuit.com)

**SHARP**

Spec No.	DG-123043A
Issue	14-May-12

**S P E C I F I C A T I O N S**

Product Type **ZENIGATA LED**

---

Model No. **GW5SMB\*\*P0C**

---

**\*\* : 27, 30, 40, 50, 60**

※These specifications contain 19 pages including the cover and appendix.  
 If you have any objections, please contact us before issuing purchasing order.

CUSTOMERS ACCEPTANCE

DATE: \_\_\_\_\_

BY: \_\_\_\_\_

**Reference**

PRESENTED

BY: \_\_\_\_\_  
 T. Uemura  
 Dept. General Manager

REVIEWED BY: \_\_\_\_\_ PREPARED BY: \_\_\_\_\_

Development Department II  
 Lighting Device Division  
 Electronic Components And Devices Group  
 SHARP CORPORATION

**SHARP**Model No. GW5SMB\*\*P0C

- Handle this document carefully for it contains material protected by international copyright law. Any reproduction, full or in part, of this material is prohibited without the express written permission of the company.
  
- When using the products covered herein, please observe the conditions written herein and the precautions outlined in the following paragraphs. In no event shall the company be liable for any damages resulting from failure to strictly adhere to these conditions and precautions.
  - (1) Please do verify the validity of this part after assembling it in customer's products, when customer wants to make catalogue and instruction manual based on the specification sheet of this part.
  
  - (2) The products covered herein are designed and manufactured for the following application areas. When using the products covered herein for the equipment listed in paragraph (3), even for the following application areas, be sure to observe the precautions given in Paragraph (3). Never use the products for the equipment listed in Paragraph (4).
    - Office electronics
    - Instrumentation and measuring equipment
    - Machine tools
    - Audiovisual equipment
    - Home appliances
    - Communication equipment other than for trunk lines
  
  - (3) These contemplating using the products covered herein for the following equipment which demands high reliability, should first contact a sales representative of the company and then accept responsibility for incorporating into the design fail-safe operation, redundancy, and other appropriate measures for ensuring reliability and safety of the equipment and the overall system.
    - Control and safety devices for airplanes, trains, automobiles, and other transportation equipment
    - Mainframe computers
    - traffic control systems
    - Gas leak detectors and automatic cutoff devices
    - Rescue and security equipment
    - Other safety devices and safety equipment, etc.
  
  - (4) Do not use the products covered herein for the following equipment which demands extremely high performance in terms of functionality, reliability, or accuracy.
    - Aerospace equipment
    - Communications equipment for trunk lines
    - Control equipment for the nuclear power industry
    - Medical equipment related to life support, etc.
  
  - (5) please direct all queries and comments regarding the interpretation of the above four Paragraphs to a sales representative of the company.
  
- Please direct all queries regarding the products covered herein to a sales representative of the company.



Model No. <b>GW5SMB**P0C</b>	Page 1 of 17
---------------------------------	-----------------

**GW5SMB\*\*P0C specifications**

1. Application

These specifications apply to the light emitting diode module Model No. GW5SMB\*\*P0C.

[ LED module (InGaN Blue LED chip + Phosphor) ]

Main application : Lighting

2. External dimensions and equivalent circuit ----- Refer to Page 2.

3. Ratings and characteristics ----- Refer to Page 3 - 5.

- 3-1. Absolute maximum ratings
- 3-2. Electro-optical characteristics
- 3-3. Derating curve

4. Reliability ----- Refer to Page 6.

- 4-1. Test items and test conditions
- 4-2. Failure criteria

5. Quality level ----- Refer to Page 7.

- 5-1. Applied standard
- 5-2. Sampling inspection
- 5-3. Inspection items and defect criteria

6. Supplements----- Refer to Page 8 - 13.

- 6-1. Chromaticity rank table
- 6-2. Packing
- 6-3. Label
- 6-4. Indication printed on product

7. Precautions ----- Refer to Page 14 - 16.

8. Characteristics diagram (TYP.) ----- Refer to Page 17.

**SHARP**

Model No. <b>GW5SMB**P0C</b>	Page 2 of 17
---------------------------------	-----------------

2. External dimensions and equivalent circuit

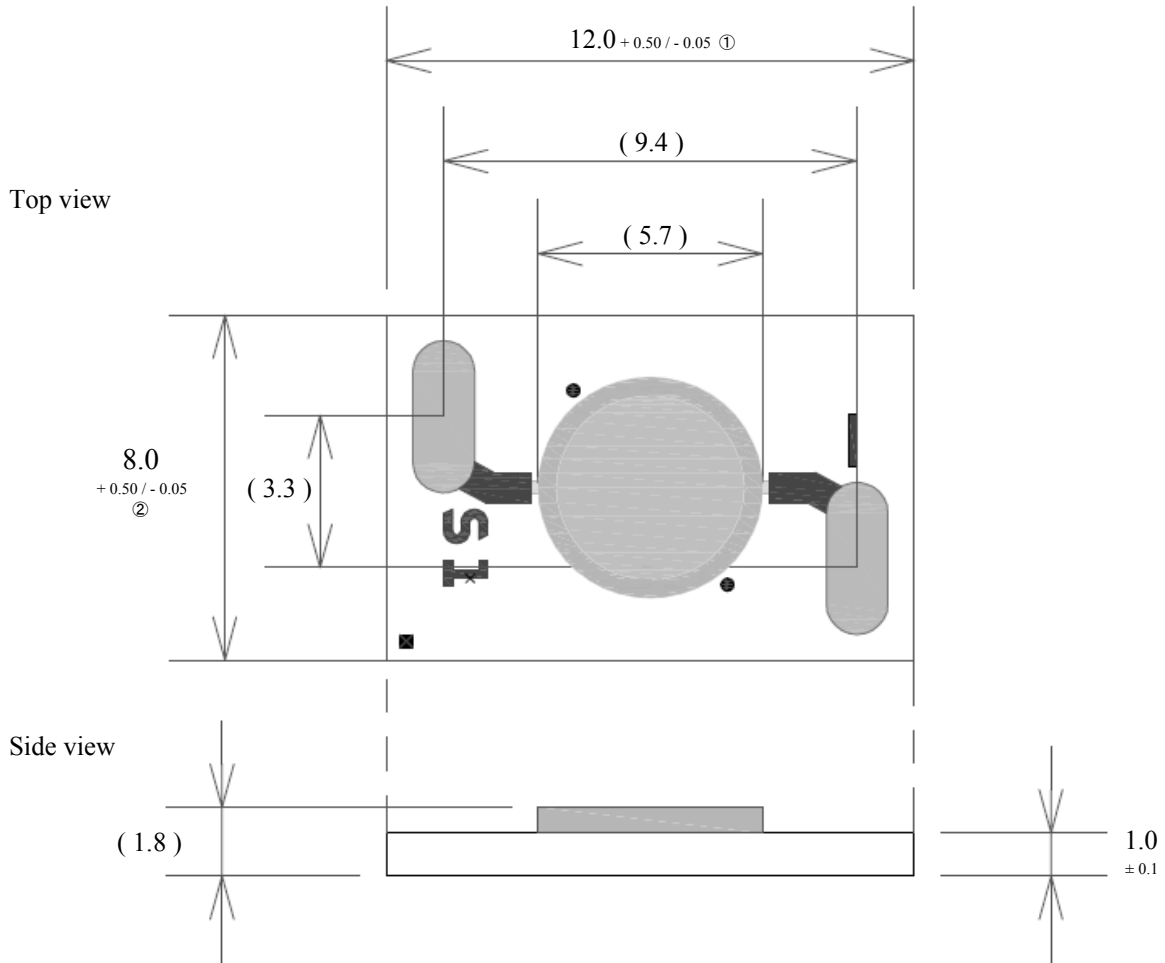

(Note) Values inside parentheses are reference values.

External dimension of ceramic substrate is the indication of maximum length at each side.

Equivalent circuit

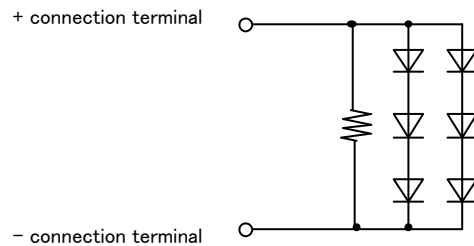

(Note) 3 series × 2 parallel = 6 pcs of LEDs

Unit	Material	Drawing No.
mm	Substrate : Alumina Ceramic	52403022

3. Ratings and characteristics

3-1. Absolute maximum ratings

Item	Symbol	Rating	Unit
Power Dissipation *1,4	P	4.4	W
Forward Current *1,4	I <sub>F</sub>	380	mA
Reverse Voltage *2,4	V <sub>R</sub>	-15	V
Operating Temperature *3	T <sub>opr</sub>	- 30 ~ + 100	°C
Storage Temperature	T <sub>stg</sub>	- 40 ~ + 100	°C

\*1 Power dissipation and forward current are the value when the module temperature is set lower than the rating by using an adequate heat sink.

\*2 Voltage resistible at initial connection error  
(Not dealing with the possibility of always-on reverse voltage.)

\*3 Case temperature T<sub>c</sub> (Refer to measuring point for case temperature in the next page.)  
Refer to "Derating curve" in the next page as for operating current.

\*4 T<sub>c</sub> = 25 °C



Model No. <b>GW5SMB**P0C</b>	Page 4 of 17
---------------------------------	-----------------

3-2. Electro-optical characteristics

(T<sub>c</sub> = 25 °C)

**	Item	Symbol	Condition	MIN.	TYP.	MAX.	Unit
common	Forward Voltage *5	V <sub>F</sub>	I <sub>F</sub> = 350 mA	9.0	(10.3)	11.6	V
27	Luminous Flux *6	Φ	I <sub>F</sub> = 350 mA	230	(260)	-	lm
	Chromaticity Coordinates *7	x		-	(0.460)	-	-
		y		-	(0.415)	-	-
	Color Temperature	-		-	(2700)	-	K
General Color Rendering Index *8	Ra	-	80	(82)	-	-	
30	Luminous Flux *6	Φ	I <sub>F</sub> = 350 mA	250	(280)	-	lm
	Chromaticity Coordinates *7	x		-	(0.440)	-	-
		y		-	(0.411)	-	-
	Color Temperature	-		-	(3000)	-	K
General Color Rendering Index *8	Ra	-	80	(82)	-	-	
40	Luminous Flux *6	Φ	I <sub>F</sub> = 350 mA	265	(300)	-	lm
	Chromaticity Coordinates *7	x		-	(0.385)	-	-
		y		-	(0.385)	-	-
	Color Temperature	-		-	(4000)	-	K
General Color Rendering Index *8	Ra	-	80	(82)	-	-	
50	Luminous Flux *6	Φ	I <sub>F</sub> = 350 mA	270	(310)	-	lm
	Chromaticity Coordinates *7	x		-	(0.351)	-	-
		y		-	(0.364)	-	-
	Color Temperature	-		-	(5000)	-	K
General Color Rendering Index *8	Ra	-	80	(82)	-	-	
60	Luminous Flux *6	Φ	I <sub>F</sub> = 350 mA	270	(310)	-	lm
	Chromaticity Coordinates *7	x		-	(0.321)	-	-
		y		-	(0.340)	-	-
	Color Temperature	-		-	(6000)	-	K
General Color Rendering Index *8	Ra	-	80	(82)	-	-	

(Note) Values inside parentheses are shown for reference purpose only.

\*5 (After 20 ms drive, Measurement tolerance: ± 3 %)

\*6 Monitored by Sharp's 8 inch integrating sphere and Otsuka electronics MCPD-LE3400  
(After 20 ms drive, Measurement tolerance: ± 10 %)

\*7 Monitored by Sharp's 8 inch integrating sphere and Otsuka electronics MCPD-LE3400  
(After 20 ms drive, Measurement tolerance: ± 0.005)

\*8 Monitored by Sharp's 8 inch integrating sphere and Otsuka electronics MCPD-LE3400  
(After 20 ms drive, Measurement tolerance: ± 2)

3-3. Derating curve

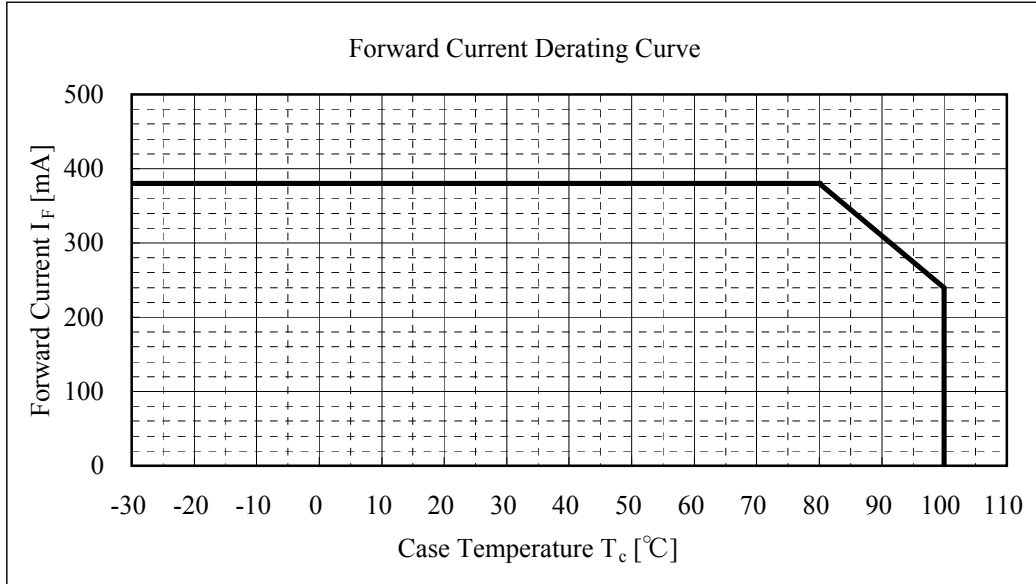

(Note) To keep the case temperature lower than the rating, enough heat-radiation performance needs to be secured by using an adequate heat sink.

For soldering connection, please evaluate in your circumstance to make sure soldering reliability.

( Above derating curve is specified to LED device, not for soldering connection )

And please consider to avoid physical stress between wire and substrate, and some protection like silicon bond on top of soldered wire is recommended.

(Measuring point for case temperature)

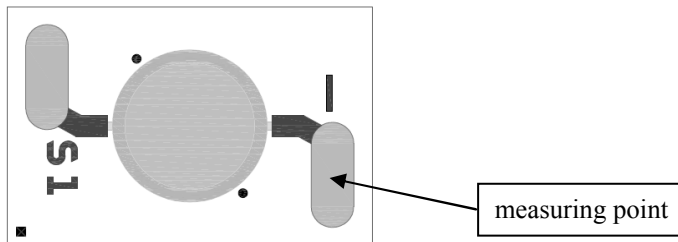





Model No. <b>GW5SMB**P0C</b>	Page 6 of 17
---------------------------------	-----------------

4. Reliability

The reliability of products shall be satisfied with items listed below.

4-1. Test items and test conditions

Confidence level: 90 %

No.	Test item	Test conditions	Samples n	Defective C	LTPD (%)
1	Temperature Cycle	- 40 °C(30 min) ~ + 100 °C(30 min), 100 cycles	11	0	20
2	Temperature Humidity Storage	T <sub>stg</sub> = + 60 °C, RH = 90 %, Time = 1000 h	11	0	20
3	High Temperature Storage	T <sub>stg</sub> = + 100°C, Time = 1000 h	11	0	20
4	Low Temperature Storage	T <sub>stg</sub> = - 40 °C, Time = 1000 h	11	0	20
5	Steady State Operating Life	T <sub>c</sub> = 60 °C, I <sub>F</sub> = 380 mA, Time = 1000 h	11	0	20
6	Shock	Acceleration: 15000 m/s <sup>2</sup> , Pulse width: 0.5 ms Direction: 3 directions (X, Y and Z) 3 trials in each direction	5	0	50
7	Vibration	Frequency: 100 to 2000 Hz for 4 minutes per trial Acceleration: 200 m/s <sup>2</sup> Direction: 3 directions (X, Y and Z) 4 trials in each direction	5	0	50

4-2. Failure criteria

No.	Parameter	Symbol	Failure criteria
1	Forward Voltage	V <sub>F</sub>	V <sub>F</sub> > Initial value × 1.1
2	Luminous Flux	Φ	Φ < Initial value × 0.7

**SHARP**

Model No. <b>GW5SMB**P0C</b>	Page 7 of 17
---------------------------------	-----------------

5. Quality level

5-1. Applied standard

ISO2859-1

5-2. Sampling inspection

A single normal sampling plan, level S-4.

5-3. Inspection items and defect criteria

No.	Item	Defect criteria	Classification	AQL
1	No radiation	No light emitting	Major defect	0.1
2	Electro-optical characteristics	Not conforming to the specification (Forward voltage, Luminous flux and Chromaticity)	Minor defect	0.4
3	External dimensions	Not conforming to the specified dimensions (External dimensions of ① and ② shown in Page 2)		
4	Appearance	Nonconformity observed in product appearance is determined as defective only when electro-optical characteristics is affected by. <If any question arises regardless of above mentioned criterion> <ul style="list-style-type: none"> <li>■ Foreign material, scratch, or bubble at emitting area: 0.8 mm φ</li> <li>■ Fiber generation at emitting area: 0.2 mm in width and 2.5 mm in length</li> <li>■ Foreign material at connection terminal: 0.8 mm φ</li> <li>■ Substrate burr on edge: Over dimension tolerance</li> </ul>		

(Note) Products with removable foreign material attached on is not determined to be defective.

**SHARP**

Model No.  
**GW5SMB\*\*P0C**

Page  
8 of 17

6. Supplements

6-1. Chromaticity rank table

(Tolerance:  $x, y \pm 0.005$ )  
( $I_F = 350 \text{ mA}, T_c = 25 \text{ }^\circ\text{C}$ )

\*\* : 27

Rank		Chromaticity coordinates			
		Point 1	Point 2	Point 3	Point 4
1	x	0.4579	0.4526	0.4624	0.4681
	y	0.4200	0.4100	0.4100	0.4200

Chromaticity Diagram

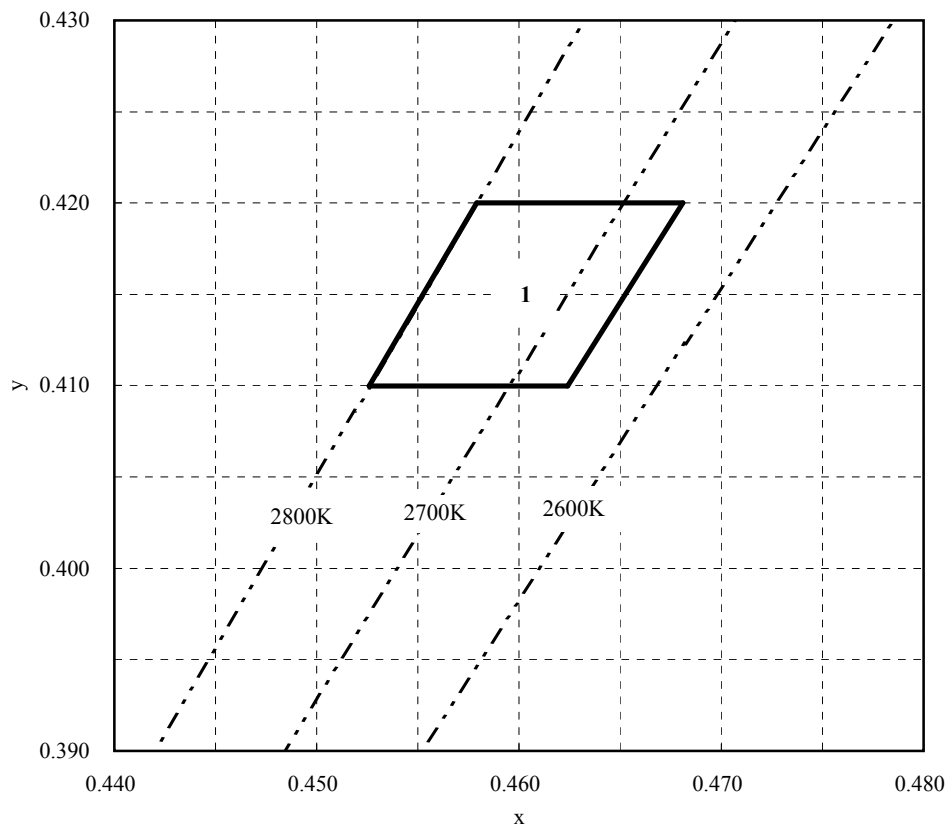

**SHARP**

Model No.  
**GW5SMB\*\*P0C**

Page  
9 of 17

(Tolerance:  $x, y \pm 0.005$ )  
( $I_F = 350 \text{ mA}$ ,  $T_c = 25 \text{ }^\circ\text{C}$ )

\*\* : 30

Rank		Chromaticity coordinates			
		Point 1	Point 2	Point 3	Point 4
1	x	0.4386	0.4339	0.4422	0.4473
	y	0.4150	0.4050	0.4050	0.4150

Chromaticity Diagram

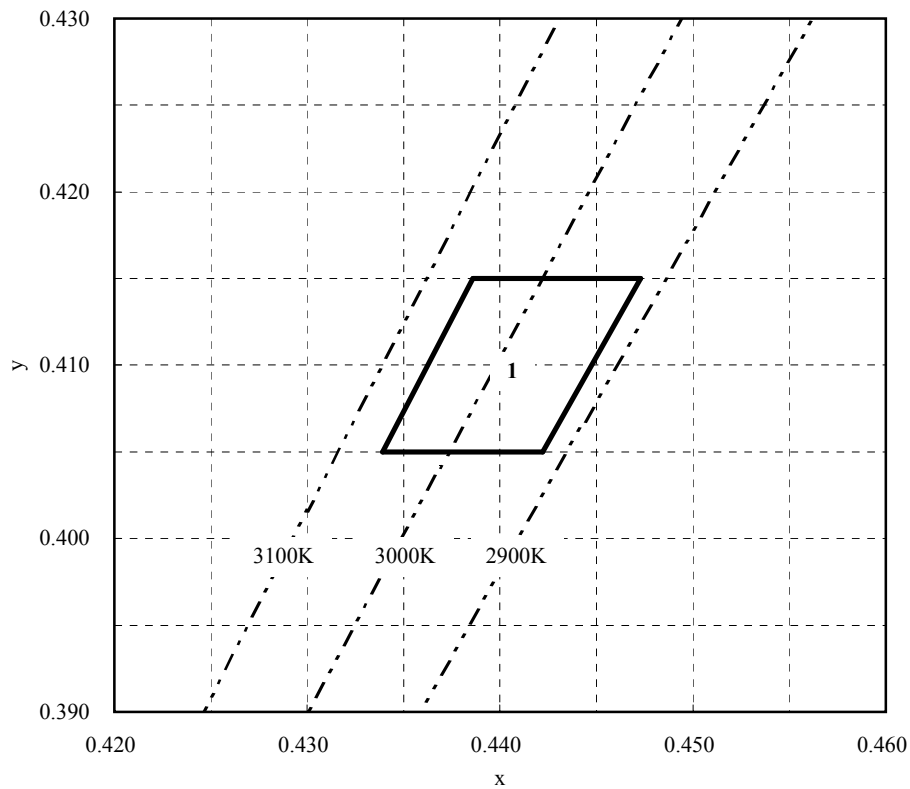

**SHARP**

Model No.  
**GW5SMB\*\*P0C**

Page  
10 of 17

(Tolerance:  $x, y \pm 0.005$ )  
( $I_F = 350 \text{ mA}$ ,  $T_c = 25 \text{ }^\circ\text{C}$ )

\*\* : 40

Rank		Chromaticity coordinates			
		Point 1	Point 2	Point 3	Point 4
1	x	0.3821	0.3795	0.3870	0.3900
	y	0.3900	0.3800	0.3800	0.3900

Chromaticity Diagram

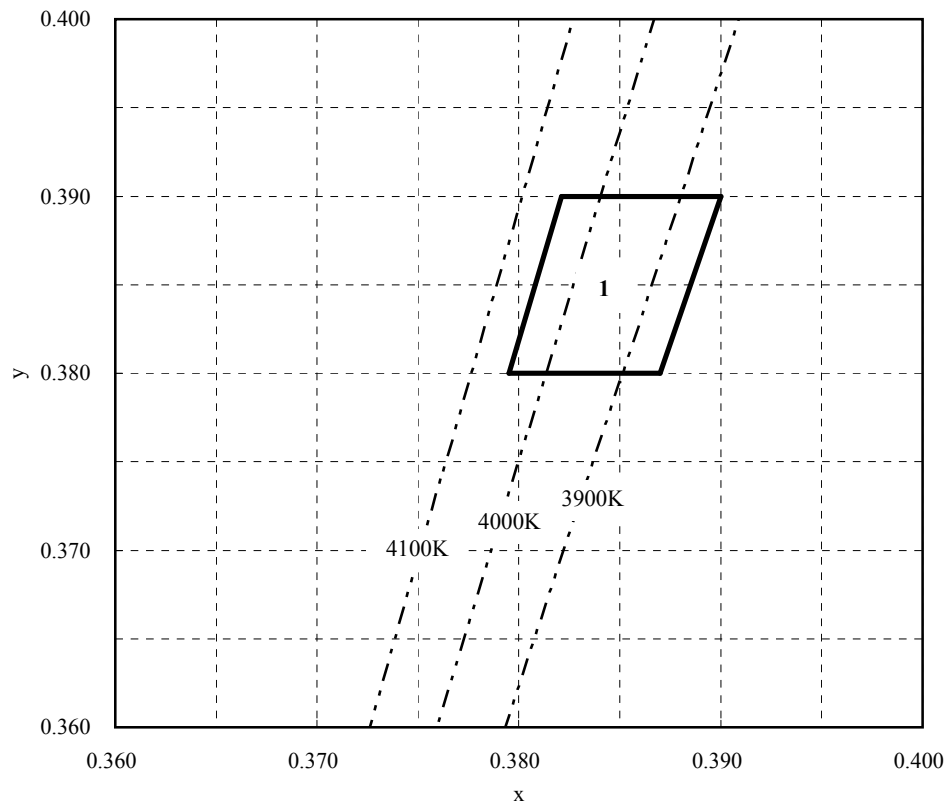

**SHARP**

Model No.  
**GW5SMB\*\*P0C**

Page  
11 of 17

(Tolerance:  $x, y \pm 0.005$ )  
( $I_F = 350 \text{ mA}$ ,  $T_c = 25 \text{ }^\circ\text{C}$ )

\*\* : 50

Rank		Chromaticity coordinates			
		Point 1	Point 2	Point 3	Point 4
1	x	0.3452	0.3437	0.3556	0.3585
	y	0.3680	0.3500	0.3595	0.3788

Chromaticity Diagram

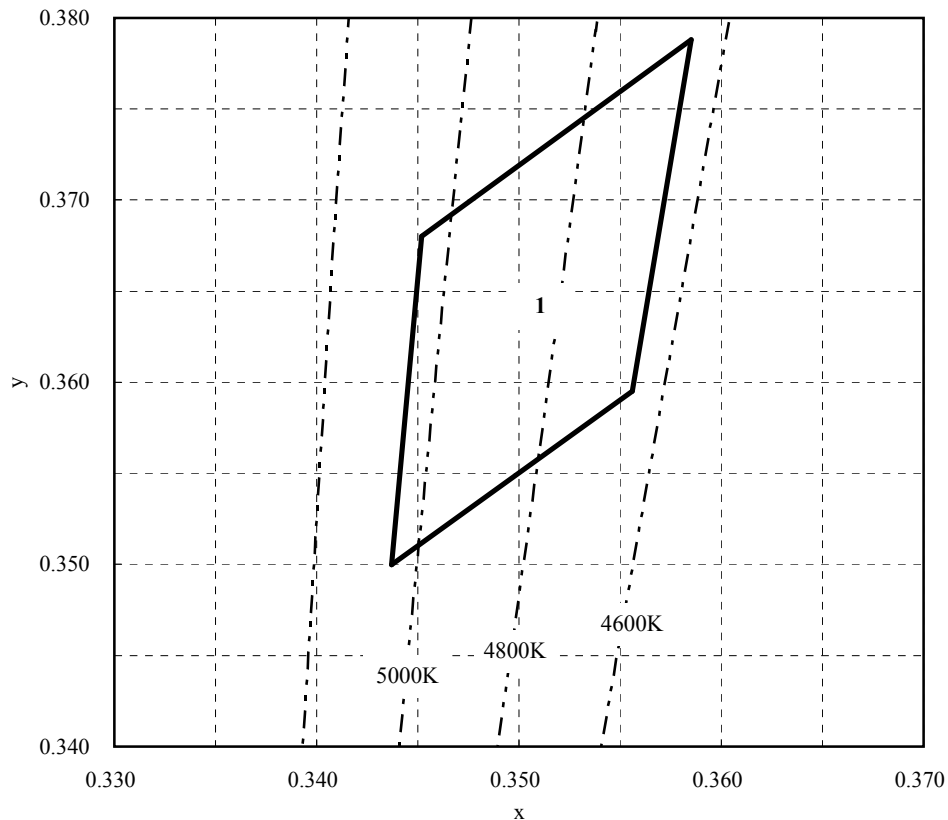

**SHARP**

Model No.  
**GW5SMB\*\*P0C**

Page  
12 of 17

(Tolerance:  $x, y \pm 0.005$ )  
( $I_F = 350 \text{ mA}$ ,  $T_c = 25 \text{ }^\circ\text{C}$ )

\*\* : 60

Rank		Chromaticity coordinates			
		Point 1	Point 2	Point 3	Point 4
1	x	0.3132	0.3152	0.3280	0.3276
	y	0.3408	0.3250	0.3370	0.3552

Chromaticity Diagram

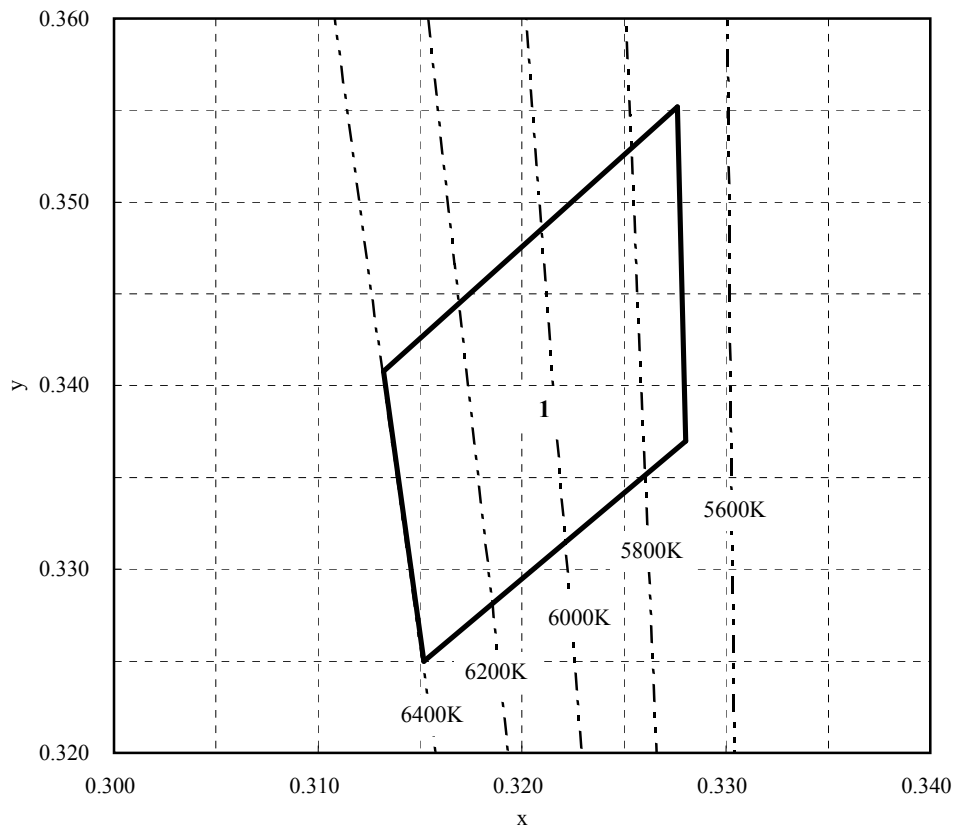

6-2. Packing

- One tray composed of 120 pieces
- 5 trays (600 pieces) and one upper lid-tray in one moisture-proof bag
- 2 bags (1,200 pieces) in one carton
- Dimensions of outer carton: 235 × 220 × 90 mm (Reference value)

(Note 1) There are cases of one carton composed of one bag. (600 pieces)

(Note 2) State of packing is subject to change.

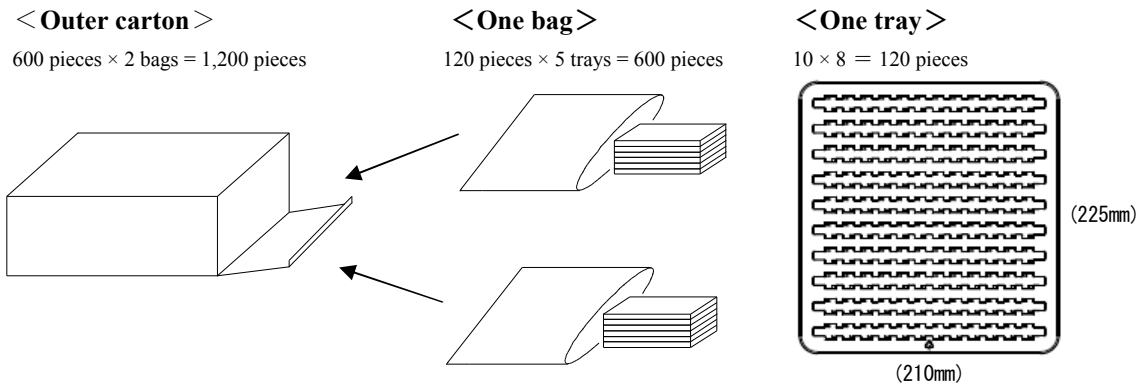

6-3. Label

Following label is attached on moisture-proof bags.

(Note 3) Label format is subjected to change.



- ← Model number
- ← (Model number + suffix code)
- ← Quantity and rank
- ← Lot No.
- ← Bar code
- ← Production country
  - MADE IN PHILIPPINES
  - MADE IN INDONESIA

1) Lot No. indication

X X 2 2 G 0 1 0 0 1 A  
① ② ③ ④ ⑤ ⑥ ⑦

- ① Production plant code (PHL (MAT):50, IDN (SSI):00)
- ② Shipping year (Year last digit)
- ③ Shipping month (1~9 or O, N, D)
- ④ Fixed code G
- ⑤ Shipping date (01~31)
- ⑥ Serial No.
- ⑦ Backup code A

6-4. Indication printed on product

Control No. is indicated on substrate surface.

1) Control No.

Indicated as follows;

**X X B 0 1**  
① ② ③

① Model code

SMB**P0C	XX
27	54
30	55
40	56
50	57
60	58

② Month of production

(to be indicated alphabetically with January corresponding to A)

③ Date of production (01~31)

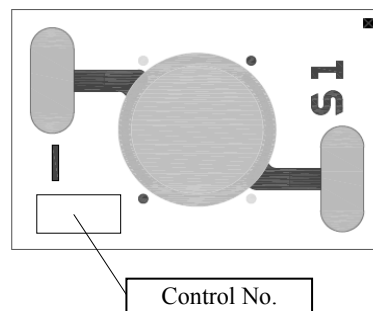



## 7. Precautions

### ① Storage conditions

Please follow the conditions below.

- Before opened: Temperature 5 ~ 30 °C, Relative humidity less than 60 %.  
(Before opened LED should be used within a year)
- After opened: Temperature 5 ~ 30 °C, Relative humidity less than 60 %.  
(Please apply soldering within 1 week)
- After opened LED should be kept in an aluminum moisture proof bag with a moisture absorbent material (silica gel).
- Avoid exposing to air with corrosive gas.  
If exposed, electrode surface would be damaged, which may affect soldering.

### ② Usage conditions

This product is not designed for the use under any of the following conditions.

Please confirm performance and reliability well enough if you use under any of the following conditions;

- In a place with a lot of moisture, dew condensation, briny air, and corrosive gas.  
(Cl, H<sub>2</sub>S, NH<sub>3</sub>, SO<sub>2</sub>, NO<sub>x</sub>, etc.)
- Under the direct sunlight, outdoor exposure, and in a dusty place.
- In water, oil, medical fluid, and organic solvent.
- Please do not use component parts contain sulfur (gasket packing, adhesive material, etc.).

### ③ Heat radiation

If forward current ( $I_F$ ) is applied to single-state module at any current, there is a risk of damaging LED or emitting smoke.

Equip with specified heat radiator, and avoid heat stuffed inside the module.

### ④ Installation

Material of board is alumina ceramic. If installed inappropriately, trouble of no radiation may occur due to board crack or overheat. Please take particular notice for installation.

Refer to the following cautions on installation.

- Apply thermolysis adhesive, adhesive sheet or peculiar connector when mounted on heat radiator.  
In case of applying adhesive or adhesive sheet only, check the effectiveness and reliability before fixing.  
If LED comes off from heat radiator, unusual temperature rise entails hazardous phenomena including device deterioration, coming off of solder at leads, and emitting smoke.
- When LED device is mechanically fixed or locked, Please take into consideration regarding the method of attachment due to fail from stress.
- Avoid convexly uneven boards.  
Convex board is subject to substrate cracking or debasement of heat release.
- It is recommended to apply adhesive or adhesive sheet with high thermal conductivity for radiation of heat effectively.
- Please take care about the influence of color change of adhesive or adhesive sheet in initial and long term period, which may affect light output or color due to change of reflectance from backside.

- Do not touch resin part including white resin part on the surface of LED.  
No light emission may occur due to damage of resin or cutting wire of LEDs by outer force.  
When using tweezers, please handle by ceramic substrate part and avoid touching resin part.  
For mounting, please handle by side part of ceramic or the specified area shown below.

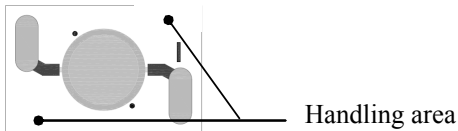

⑤ Connecting method

In case of solder connecting method, follow the conditions mentioned below.

- Use Soldering iron with thermo controller (tip temperature 380 °C), within 5 seconds per one place.
- Secure the solderwettability on whole solder pad and leads.
- During the soldering process, put the ceramic board on materials whose conductivity is poor enough not to radiate heat of soldering.
- Warm up (with using a heated plate) the substrate is recommended before soldering.  
( preheat condition: 100 °C ~ 150 °C, within 60 sec )
- Avoid touching a part of resin with soldering iron.
- This product is not designed for reflow and flow soldering.
- Avoid such lead arrangement as applying stress to solder-applied area.
- Please do not detach solder and make re-solder.
- Please solder evenly on each electrodes.
- Please prevent flux from touching to resin.

⑥ Static electricity

This product is subject to static electricity, so take measures to cope with it.  
Install circuit protection device to drive circuit, if necessary.

⑦ Drive method

- Any reverse voltage cannot be applied to LEDs when they are in operation or not.  
Design a circuit so that any flow of reverse or forward voltage can not be applied to LEDs when they are out of operation.
- Module is composed of LEDs connected in both series and parallel.  
Constant voltage power supply runs off more than specified current amount due to lowered  $V_F$  caused by temperature rise.  
Constant current power supply is recommended to drive.

⑧ Cleaning

Avoid cleaning, since silicone resin is eroded by cleaning.

⑨ Color-tone variation

Chromaticity of this product is monitored by integrating sphere right after the operation.  
Chromaticity varies depending on measuring method, light spread condition, or ambient temperature.  
Please verify your actual conditions before use.

# SHARP

Model No. <b>GW5SMB**P0C</b>	Page 16 of 17
---------------------------------	------------------

## ⑩ Safety

- Looking directly at LEDs for a long time may result in hurt your eyes.
- In case that excess current (over ratings) are supplied to the device, hazardous phenomena including abnormal heat generation, emitting smoke, or catching fire can be caused.  
Take appropriate measures to excess current and voltage.
- In case of solder connecting method, there is a possibility of fatigue failure by heat.  
Please fix the leads in such case to protect from short circuit or leakage of electricity caused by contact.
- Please confirm the safety standards or regulations of application devices.
- Please careful not to injure your hand by edge of ceramic substrate.

## ⑪ Other cautions

Guarantee covers the compliance to the quality standards mentioned in the Specifications, however it does not cover the compatibility with application of the end-use, including assembly and usage environment.

In case any quality problems occurred in the application of end-use, details will be separately discussed and determined between the parties hereto.

3-4. Characteristics diagram (TYP.)

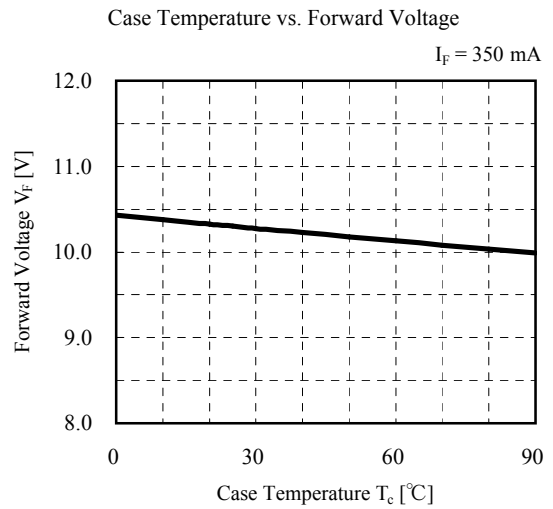
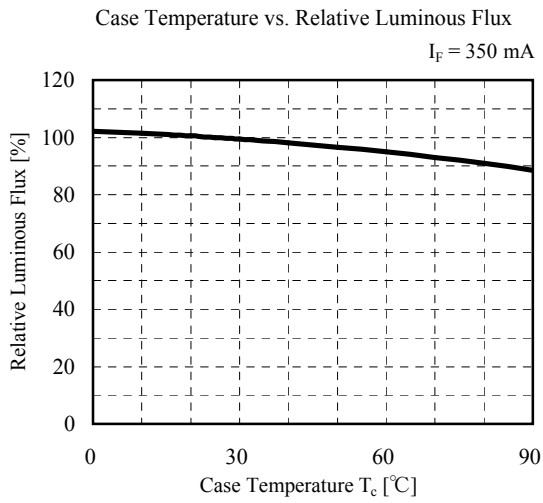
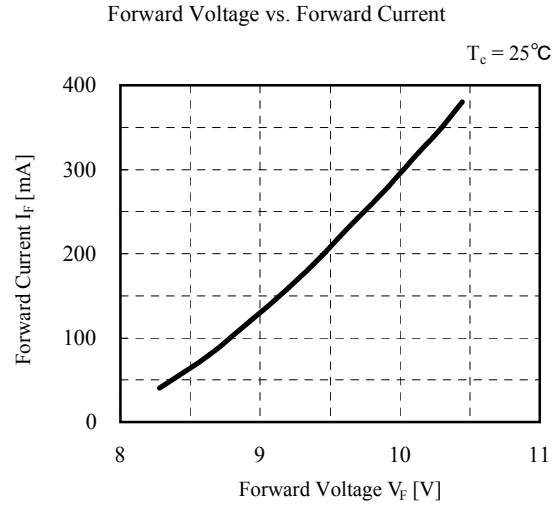
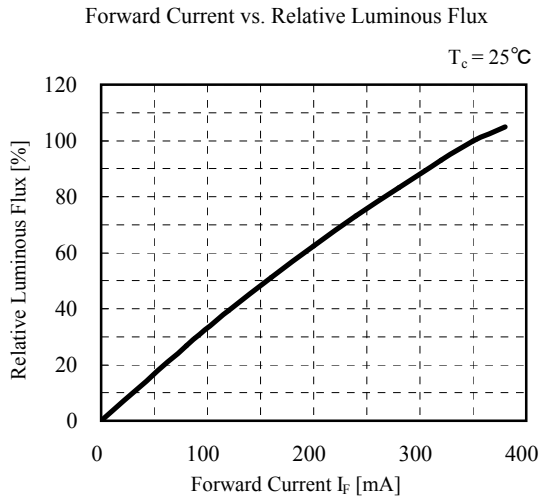

(Note) Characteristics data shown here are for reference purpose only. (Not guaranteed data)