

## Excellent Integrated System Limited

Stocking Distributor

Click to view price, real time Inventory, Delivery & Lifecycle Information:

[IXYS Corporation](#)

[VUO84-16NO7](#)

For any questions, you can email us directly:

[sales@integrated-circuit.com](mailto:sales@integrated-circuit.com)

## Standard Rectifier Module

<b>3~ Rectifier</b>	
$V_{RRM}$	= 1600 V
$I_{DAV}$	= 90 A
$I_{FSM}$	= 750 A

### 3~ Rectifier Bridge

Part number

**VUO84-16N07**



 E72873

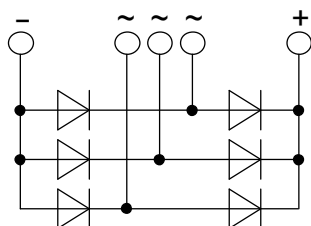

#### Features / Advantages:

- Package with DCB ceramic
- Improved temperature and power cycling
- Planar passivated chips
- Very low forward voltage drop
- Very low leakage current

#### Applications:

- Diode for main rectification
- For three phase bridge configurations
- Supplies for DC power equipment
- Input rectifiers for PWM inverter
- Battery DC power supplies
- Field supply for DC motors

#### Package: PWS-D Flat

- Industry standard outline
- RoHS compliant
- Easy to mount with two screws
- Height: 17 mm
- Base plate: Copper internally DCB isolated
- Advanced power cycling

Rectifier				Ratings			
Symbol	Definition	Conditions	min.	typ.	max.	Unit	
$V_{RSM}$	max. non-repetitive reverse blocking voltage				1700	V	
$V_{RRM}$	max. repetitive reverse blocking voltage				1600	V	
$I_R$	reverse current	$V_R = 1600\text{ V}$			100	$\mu\text{A}$	
		$V_R = 1600\text{ V}$			1.5	mA	
$V_F$	forward voltage drop	$I_F = 30\text{ A}$			1.08	V	
		$I_F = 90\text{ A}$			1.35	V	
		$I_F = 30\text{ A}$	$T_{VJ} = 125^\circ\text{C}$			0.99	V
		$I_F = 90\text{ A}$				1.33	V
$I_{DAV}$	bridge output current	$T_C = 115^\circ\text{C}$ rectangular $d = \frac{1}{3}$			90	A	
$V_{F0}$	threshold voltage	} for power loss calculation only			0.78	V	
$r_F$	slope resistance				6	m $\Omega$	
$R_{thJC}$	thermal resistance junction to case				0.9	K/W	
$R_{thCH}$	thermal resistance case to heatsink			0.4		K/W	
$P_{tot}$	total power dissipation				135	W	
$I_{FSM}$	max. forward surge current	$t = 10\text{ ms}; (50\text{ Hz}), \text{ sine}$	$T_{VJ} = 45^\circ\text{C}$			750	A
		$t = 8,3\text{ ms}; (60\text{ Hz}), \text{ sine}$	$V_R = 0\text{ V}$			810	A
		$t = 10\text{ ms}; (50\text{ Hz}), \text{ sine}$	$T_{VJ} = 150^\circ\text{C}$			640	A
		$t = 8,3\text{ ms}; (60\text{ Hz}), \text{ sine}$	$V_R = 0\text{ V}$			690	A
$I^2t$	value for fusing	$t = 10\text{ ms}; (50\text{ Hz}), \text{ sine}$	$T_{VJ} = 45^\circ\text{C}$			2.82	kA <sup>2</sup> s
		$t = 8,3\text{ ms}; (60\text{ Hz}), \text{ sine}$	$V_R = 0\text{ V}$			2.73	kA <sup>2</sup> s
		$t = 10\text{ ms}; (50\text{ Hz}), \text{ sine}$	$T_{VJ} = 150^\circ\text{C}$			2.05	kA <sup>2</sup> s
		$t = 8,3\text{ ms}; (60\text{ Hz}), \text{ sine}$	$V_R = 0\text{ V}$			1.98	kA <sup>2</sup> s
$C_J$	junction capacitance	$V_R = 400\text{ V}; f = 1\text{ MHz}$	$T_{VJ} = 25^\circ\text{C}$		27	pF	



# VUO84-16NO7

Package PWS-D Flat		Ratings				
Symbol	Definition	Conditions	min.	typ.	max.	Unit
$I_{RMS}$	RMS current	per terminal			150	A
$T_{stg}$	storage temperature		-40		125	°C
$T_{VJ}$	virtual junction temperature		-40		150	°C
<b>Weight</b>				118		g
$M_D$	mounting torque		4.25		5.75	Nm
$M_T$	terminal torque		4.25		5.75	Nm
$d_{Spp/App}$	creepage distance on surface   striking distance through air	terminal to terminal	9.5			mm
$d_{Spb/Abp}$		terminal to backside	13.0			mm
$V_{ISOL}$	isolation voltage	t = 1 second	3000			V
		t = 1 minute	2500			V

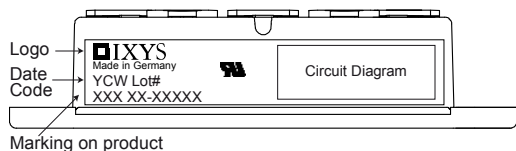

Ordering	Part Number	Marking on Product	Delivery Mode	Quantity	Code No.
Standard	VUO84-16NO7	VUO84-16NO7	Box	10	508510

Similar Part	Package	Voltage class
VUO82-16NO7	PWS-D	1600

### Equivalent Circuits for Simulation

\* on die level

$T_{VJ} = 150\text{ °C}$

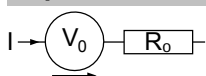

Rectifier

$V_{0\max}$	threshold voltage	0.78	V
$R_{0\max}$	slope resistance *	4.8	mΩ

Outlines PWS-D Flat

Max. allowed screw-in depth: 6 mm

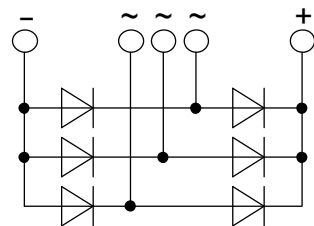
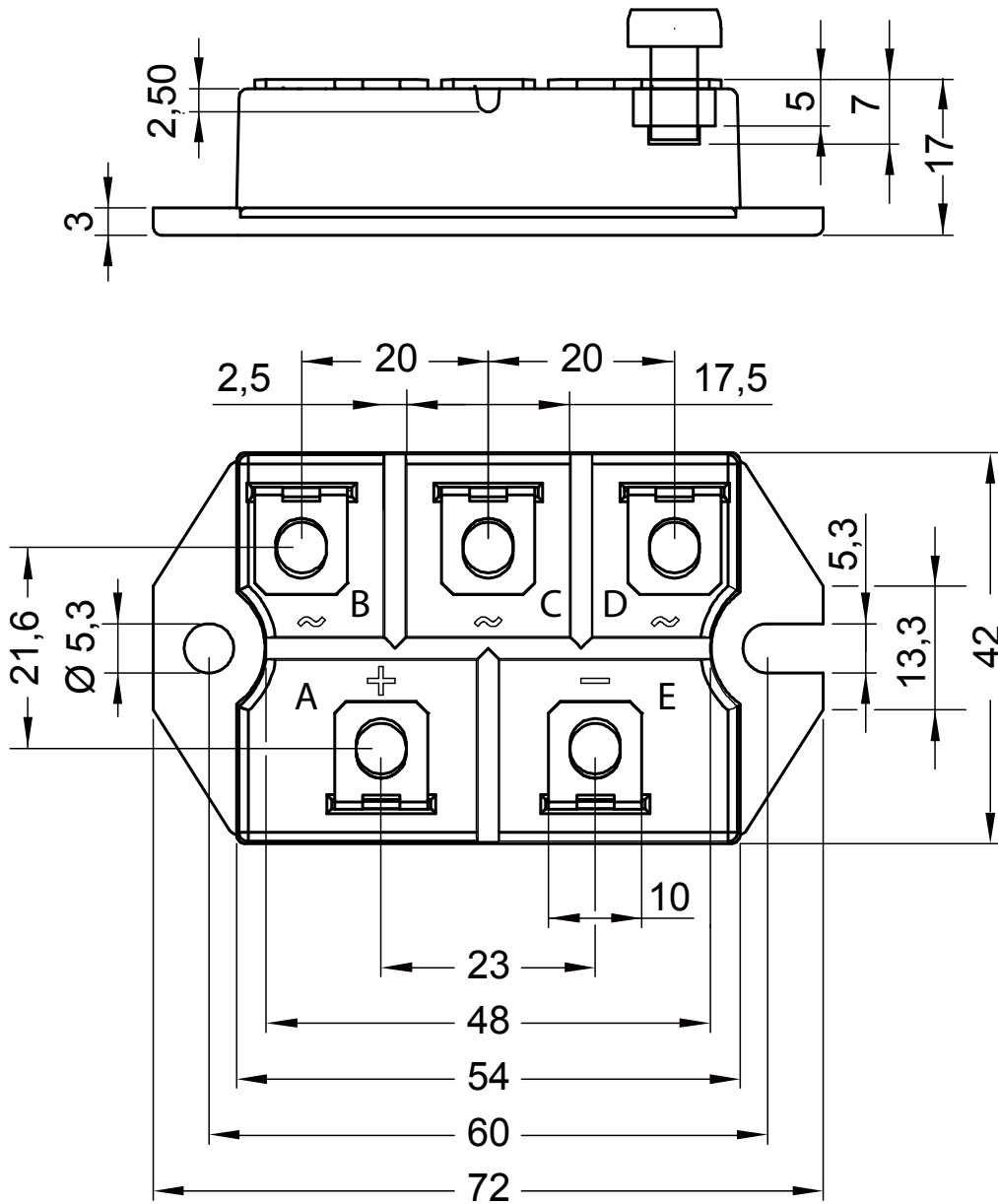

**Rectifier**

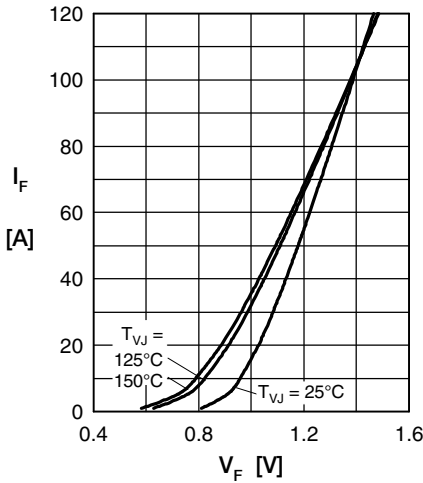

Fig. 1 Forward current versus voltage drop per diode

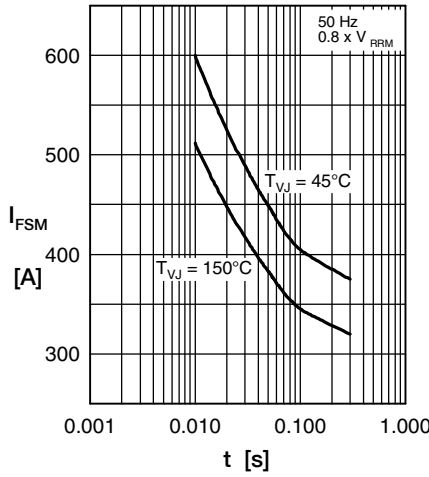

Fig. 2 Surge overload current

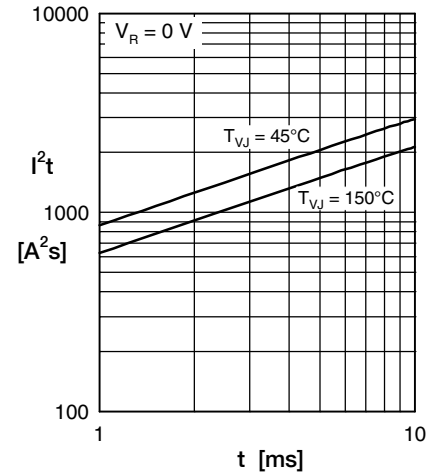

Fig. 3 I<sup>2</sup>t versus time per diode

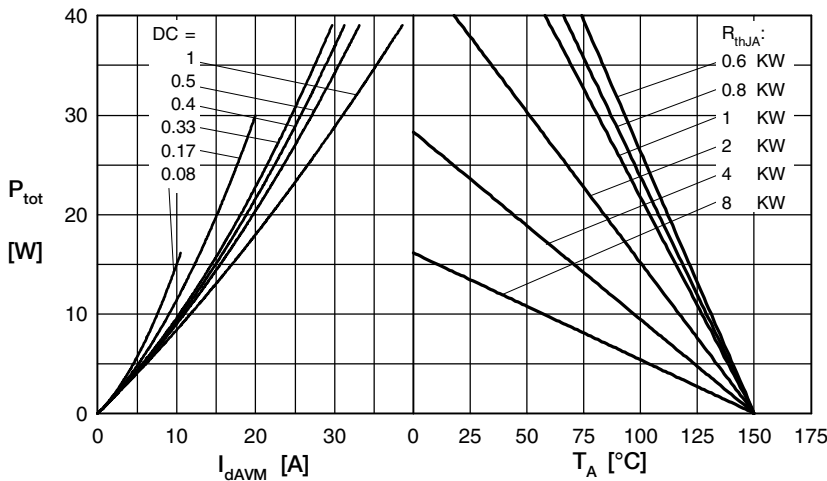

Fig. 4 Power dissipation vs. direct output current & ambient temperature

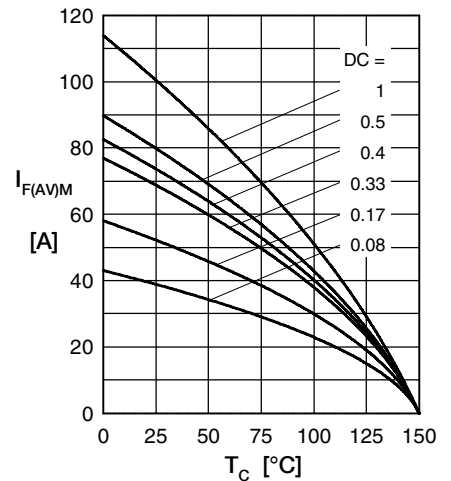

Fig. 5 Max. forward current vs. case temperature

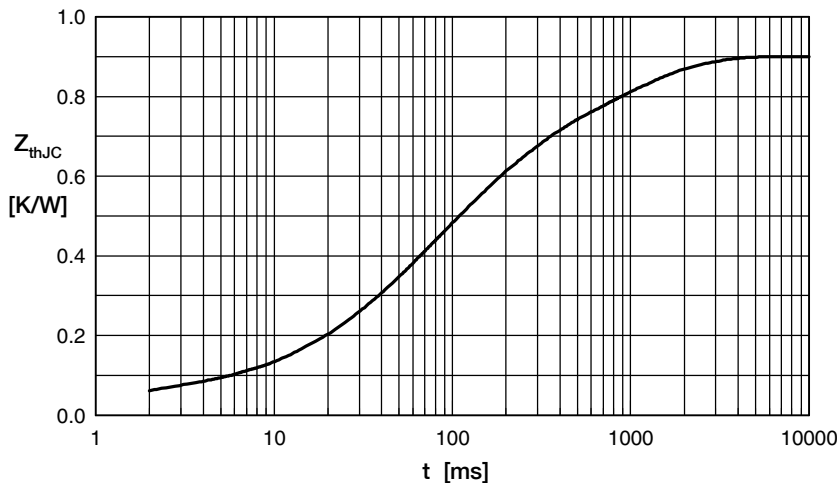

Fig. 6 Transient thermal impedance junction to case

Constants for  $Z_{thJC}$  calculation:

i	$R_{th}$ (K/W)	$t_i$ (s)
1	0.05	0.001
2	0.14	0.030
3	0.18	0.070
4	0.28	0.150
5	0.25	0.950