

Excellent Integrated System Limited

Stocking Distributor

Click to view price, real time Inventory, Delivery & Lifecycle Information:

[Infineon Technologies](#)
[ESD103B102ELSE6327XTSA1](#)

For any questions, you can email us directly:

sales@integrated-circuit.com



TVS Diodes

Transient Voltage Suppressor Diodes

ESD103-B1-02 Series

Bi-directional Femto Farad Capacitance TVS Diode

ESD103-B1-02ELS
ESD103-B1-02EL

Data Sheet

Revision 1.3, 2014-06-12
Final

Edition 2014-06-12

**Published by
Infineon Technologies AG
81726 Munich, Germany**

**© 2014 Infineon Technologies AG
All Rights Reserved.**

Legal Disclaimer

The information given in this document shall in no event be regarded as a guarantee of conditions or characteristics. With respect to any examples or hints given herein, any typical values stated herein and/or any information regarding the application of the device, Infineon Technologies hereby disclaims any and all warranties and liabilities of any kind, including without limitation, warranties of non-infringement of intellectual property rights of any third party.

Information

For further information on technology, delivery terms and conditions and prices, please contact the nearest Infineon Technologies Office (www.infineon.com)

Warnings

Due to technical requirements, components may contain dangerous substances. For information on the types in question, please contact the nearest Infineon Technologies Office.

Infineon Technologies components may be used in life-support devices or systems only with the express written approval of Infineon Technologies, if a failure of such components can reasonably be expected to cause the failure of that life-support device or system or to affect the safety or effectiveness of that device or system. Life support devices or systems are intended to be implanted in the human body or to support and/or maintain and sustain and/or protect human life. If they fail, it is reasonable to assume that the health of the user or other persons may be endangered.

1 Bi-directional Femto Farad Capacitance TVS Diode

1.1 Features

- ESD/Transient protection of RF and ultra-high speed signal lines according to:
 - **IEC61000-4-2: ±10 kV** (contact)
- Extremely low capacitance $C_L = 0.09 \text{ pF}$ (typical) at $f = 1 \text{ GHz}$
- Maximum working voltage: $V_{RWM} = \pm 15 \text{ V}$
- Very low reverse current: $I_R < 0.1 \text{ nA}$ (typ.)
- Very low series inductance down to 0.2 nH typical (TSSLP-2-4)
- Extremely small form factor down to 0.62 x 0.32 x 0.31 mm²
- Pb-free package (RoHS compliant)



1.2 Application Examples [4]

- ESD protection in RF applications
- Tailored for connectivity applications
- WLAN, GPS antenna, DVB T/H, Bluetooth Class 1 and 2
- Automated Meter Reading

1.3 Product Description

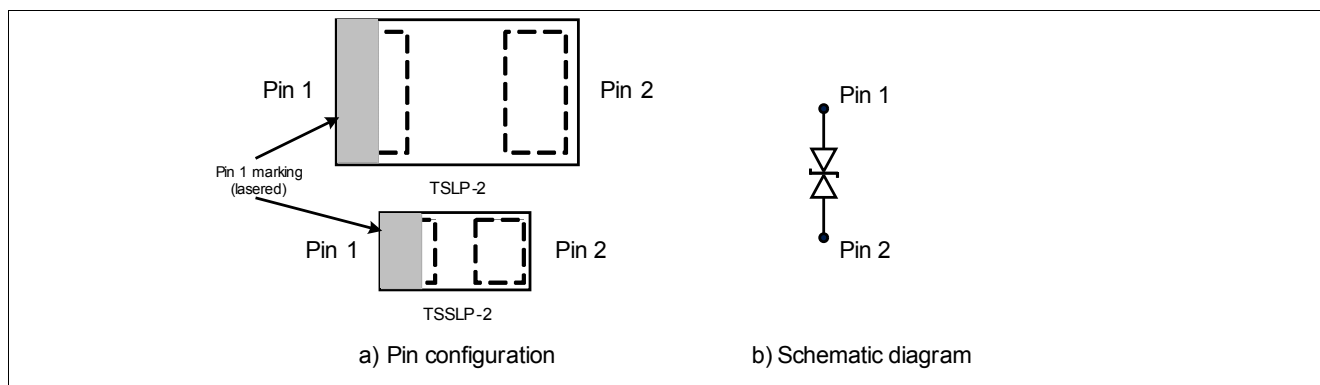

Figure 1 Pin configuration and Schematic diagram

Table 1 Ordering Information

Type	Package	Configuration	Marking code
ESD103-B1-02ELS	TSSLP-2-4	1 line, bi-directional	<u>V</u>
ESD103-B1-02EL	TSLP-2-20	1 line, bi-directional	V

2 Characteristics

Table 2 Maximum Ratings at $T_A = 25\text{ }^\circ\text{C}$, unless otherwise specified

Parameter	Symbol	Values			Unit
		Min.	Typ.	Max.	
ESD contact discharge ¹⁾	V_{ESD}	-10	–	10	kV
Operating temperature	T_{OP}	-55	–	125	$^\circ\text{C}$
Storage temperature	T_{stg}	-65	–	150	$^\circ\text{C}$

1) V_{ESD} according to IEC61000-4-2 ($R = 330\ \Omega$, $C = 150\ \text{pF}$ discharge network)

Attention: Stresses above the max. values listed here may cause permanent damage to the device. Exposure to absolute maximum rating conditions for extended periods may affect device reliability. Maximum ratings are absolute ratings; exceeding only one of these values may cause irreversible damage to the integrated circuit.

2.1 Electrical Characteristics at $T_A = 25\text{ }^\circ\text{C}$, unless otherwise specified

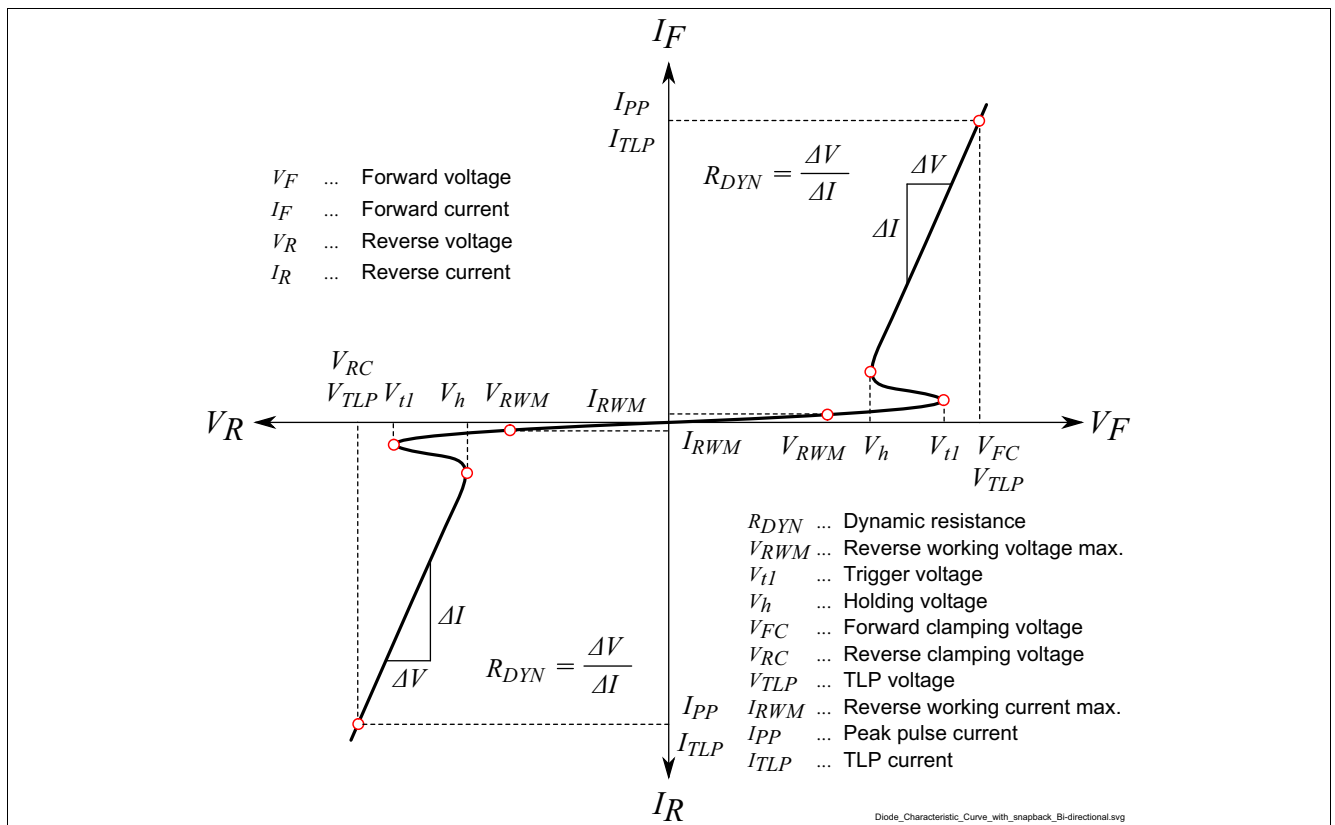

Figure 2 Definitions of electrical characteristics



ESD103-B1-02 Series

Characteristics

Table 3 DC Characteristics at $T_A = 25\text{ °C}$, unless otherwise specified

Parameter	Symbol	Values			Unit	Note / Test Condition
		Min.	Typ.	Max.		
Reverse working voltage	V_{RWM}	-15	–	15	V	
Trigger voltage	V_{Trig}	–	21	–	V	$I_{BR} = 1\text{ mA}$, from Pin 1 to Pin 2
		–	21	–		$I_{BR} = 1\text{ mA}$, from Pin 2 to Pin 1
Reverse current	I_R	–	<0.1	50	nA	$V_R = 15\text{ V}$

Table 4 RF Characteristics at $T_A = 25\text{ °C}$, unless otherwise specified

Parameter	Symbol	Values			Unit	Note / Test Condition
		Min.	Typ.	Max.		
Line capacitance	C_L	–	0.13	0.2	pF	$V_R = 0\text{ V}$, $f = 1\text{ MHz}$
		–	0.09	–		$V_R = 0\text{ V}$, $f = 1\text{ GHz}$
Series inductance	L_S	–	0.2	–	nH	ESD103-B1-02ELS ESD103-B1-02EL
		–	0.4	–		

Table 5 ESD Characteristics at $T_A = 25\text{ °C}$, unless otherwise specified

Parameter	Symbol	Values			Unit	Note / Test Condition
		Min.	Typ.	Max.		
Clamping voltage ¹⁾	V_{CL}	–	20	–	V	$I_{TLP} = 1\text{ A}$
		–	36	–		$I_{TLP} = 8\text{ A}$
		–	48	–		$I_{TLP} = 16\text{ A}$
Dynamic resistance ¹⁾	R_{DYN}	–	1.8	–	Ω	$t_p = 100\text{ ns}$

1) ANSI/ESD STM5.5.1 - Electrostatic Discharge Sensitive Testing using Transmission Line Pulse (TLP) Model. TLP conditions: $Z_0 = 50\ \Omega$, $t_p = 100\text{ ns}$, $t_r = 0.6\text{ ns}$, I_{TLP} and V_{TLP} averaging window: $t_1 = 30\text{ ns}$ to $t_2 = 60\text{ ns}$, extraction of dynamic resistance using least squares fit of TLP characteristic between $I_{TLP1} = 2\text{ A}$ and $I_{TLP2} = 14.1\text{ A}$. Please refer to Application Note AN210[1].

3 Typical Characteristics

At $T_A = 25\text{ }^\circ\text{C}$, unless otherwise specified

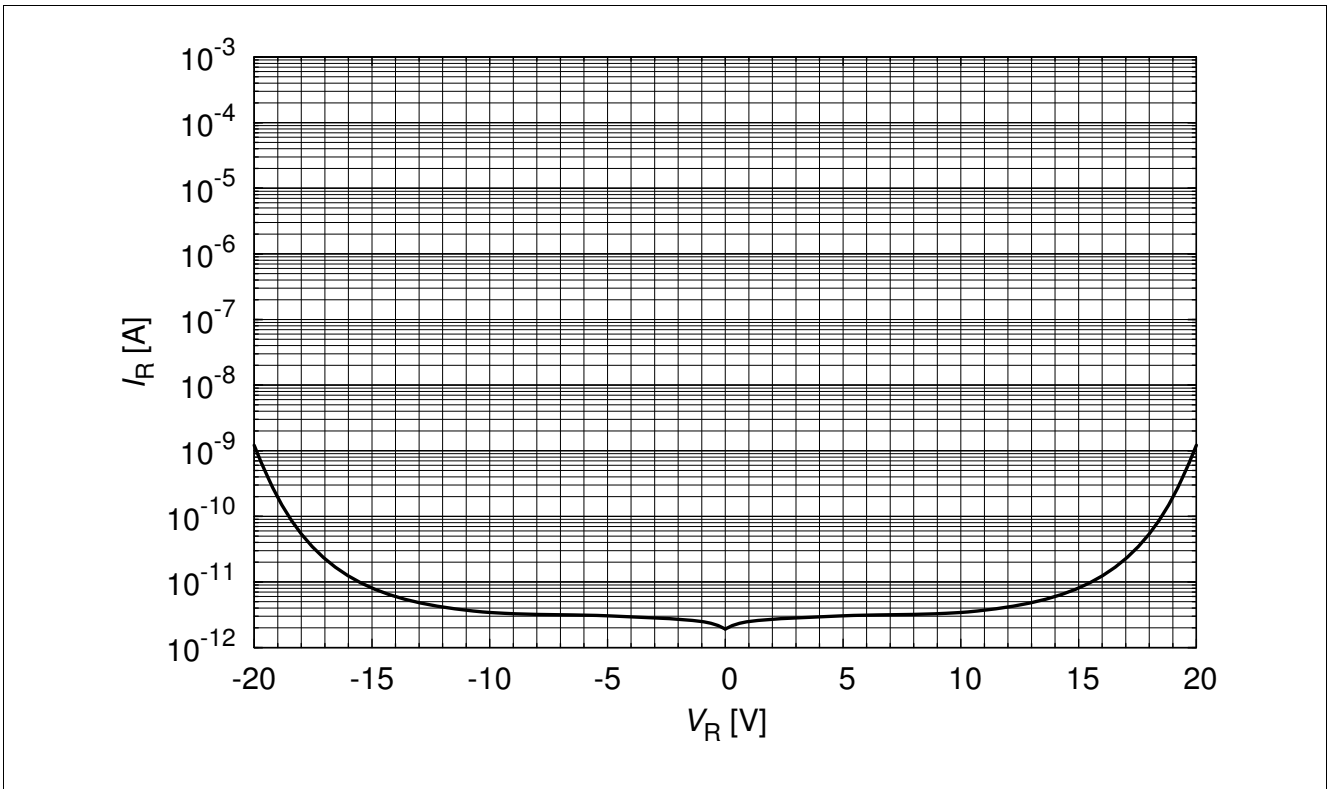

Figure 3 Reverse current $I_R = f(V_R)$

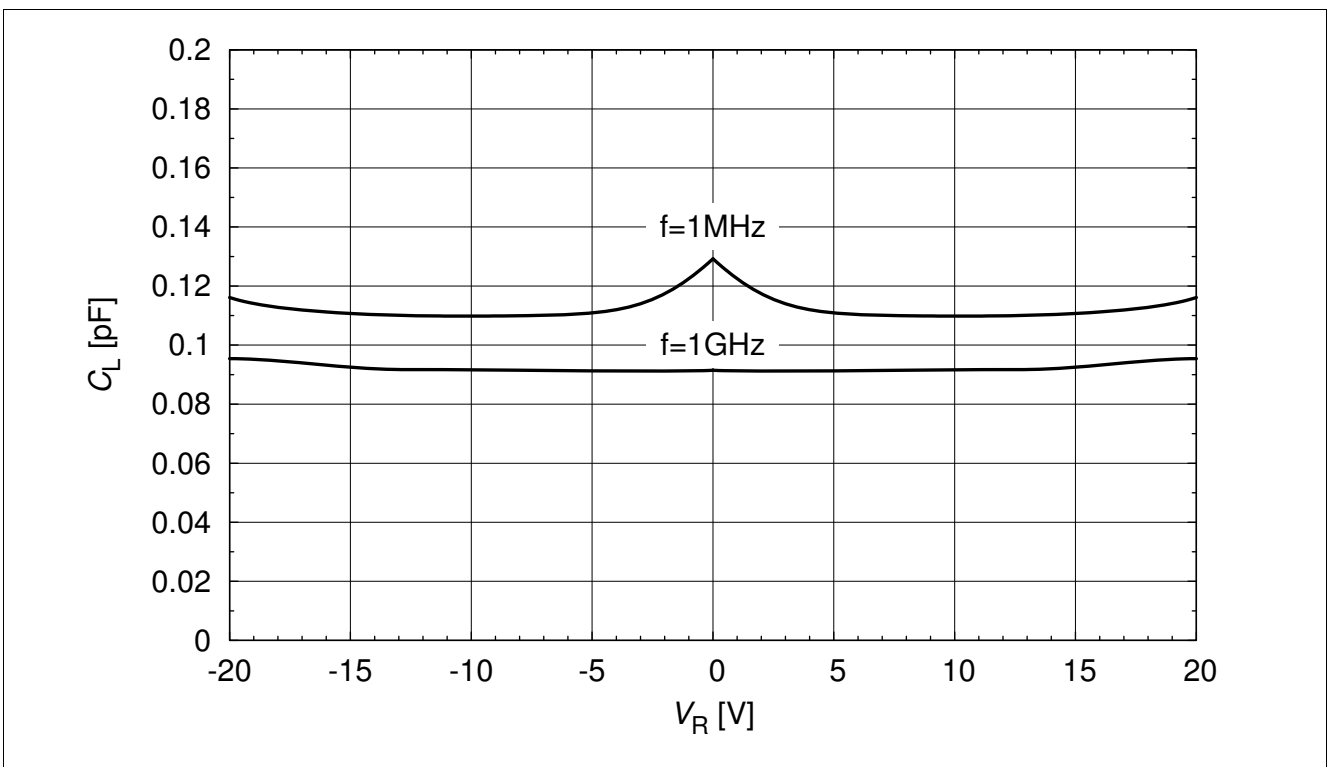

Figure 4 Line capacitance $C_L = f(V_R), f = 1\text{ MHz}$

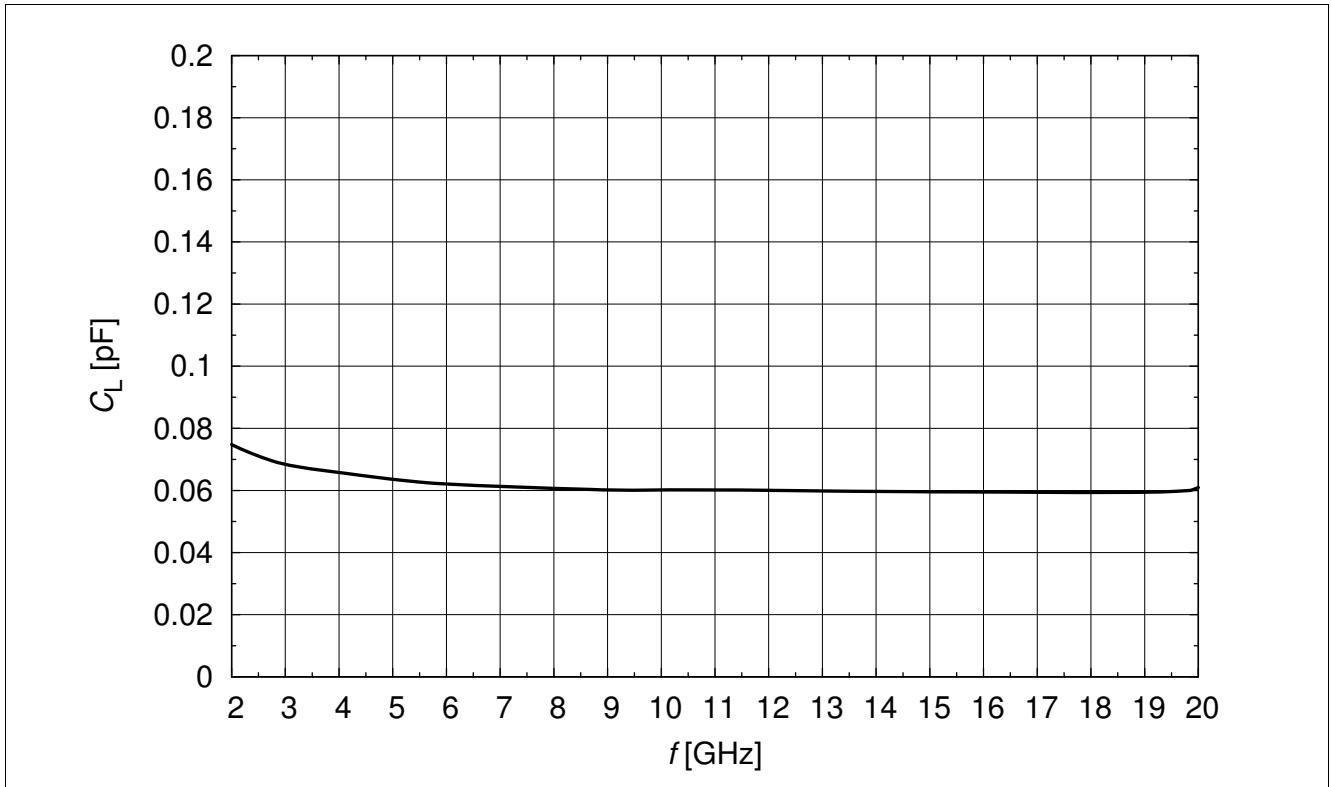

Figure 5 Line capacitance: $C_L = f(f)$, $V_R = 0$ V

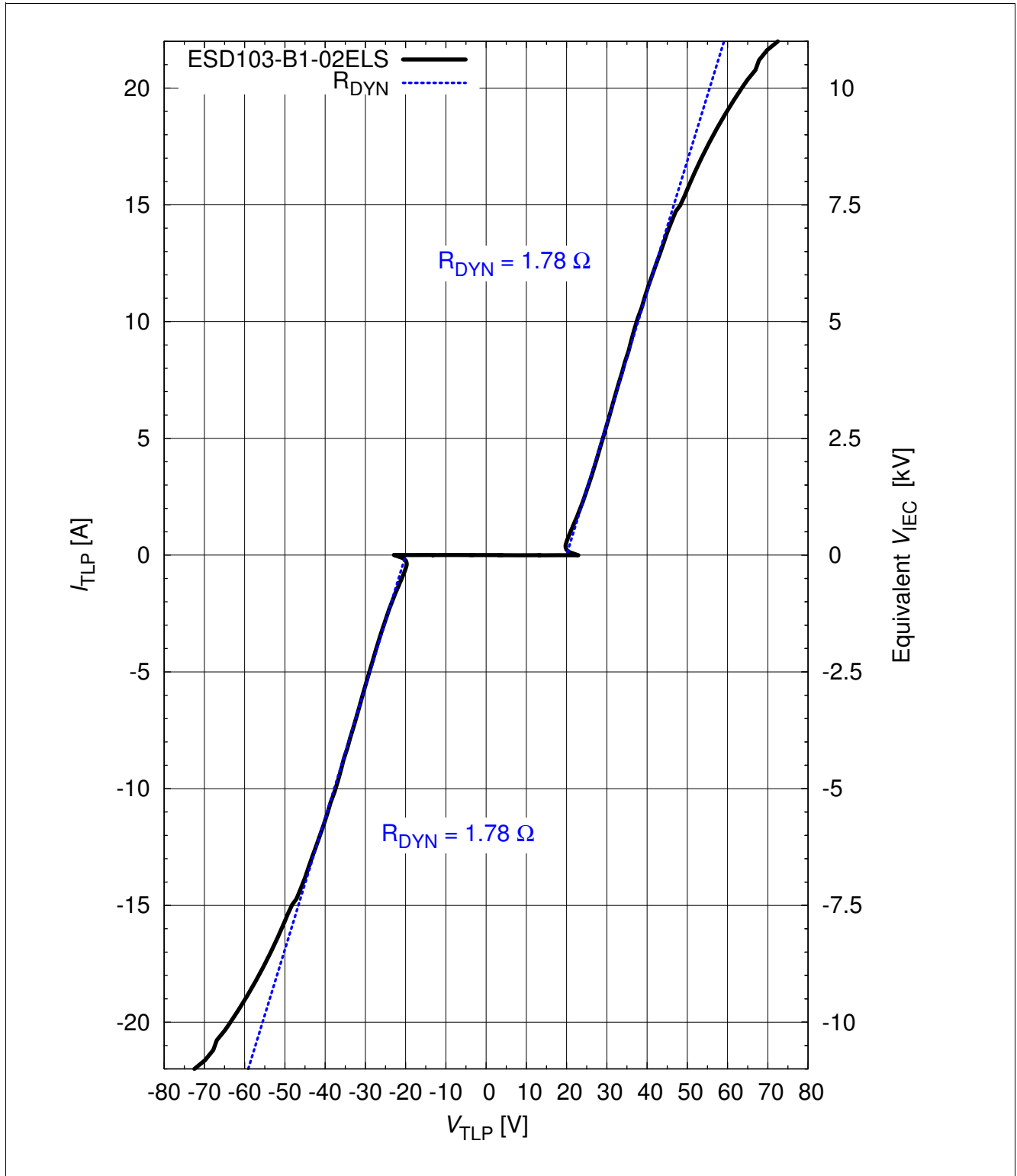

Figure 6 Clamping voltage (TLP): $I_{TLP} = f(V_{TLP})$ according ANSI/ESDSTM5.5.1-Electrostatic Discharge Sensitivity Testing using Transmission Line Pulse (TLP) Model. TLP conditions: $Z_0 = 50 \Omega$, $t_p = 100 \text{ ns}$, $t_r = 0.6 \text{ ns}$, I_{TLP} and V_{TLP} average window: $t_1 = 30 \text{ ns}$ to $t_2 = 60 \text{ ns}$, extraction of dynamic resistance using squares fit to TLP characteristics between $I_{TLP1} = 2 \text{ A}$ and $I_{TLP2} = 14.1 \text{ A}$. Please refer to Application Note AN210[1]

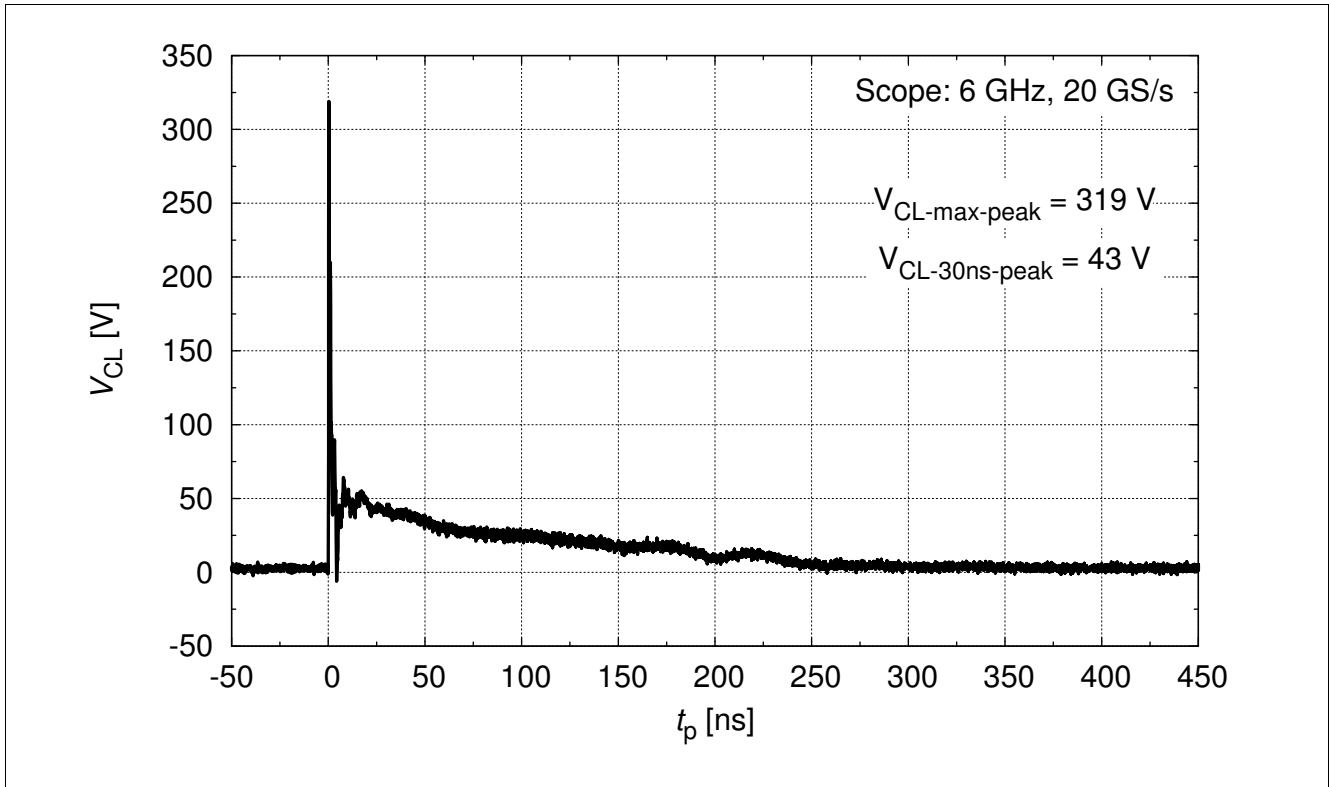

Figure 7 Clamping voltage at +8 kV discharge according IEC61000-4-2 ($R = 330 \Omega$, $C = 150 \text{ pF}$)

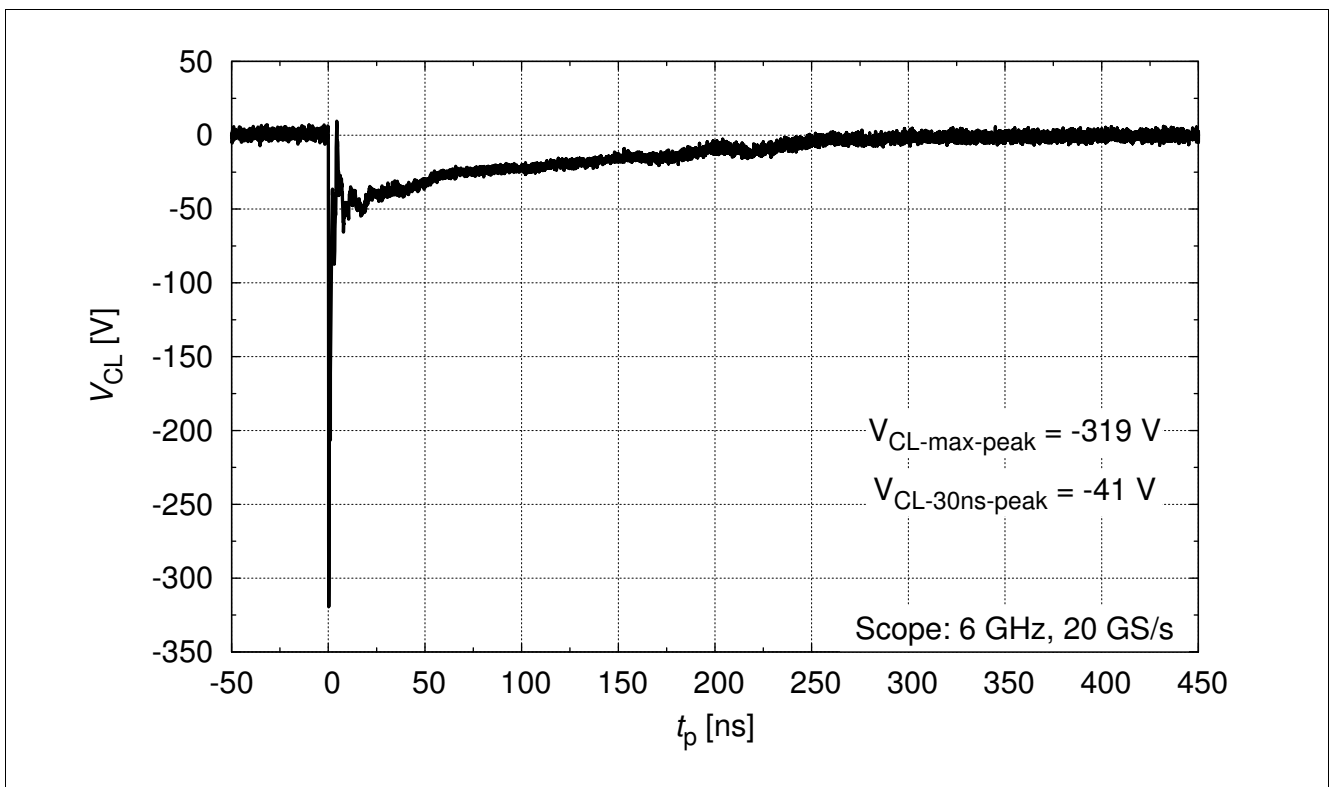

Figure 8 Clamping voltage at -8 kV discharge according IEC61000-4-2 ($R = 330 \Omega$, $C = 150 \text{ pF}$)

4 Package Information

4.1 TSSLP-2-4 [2]

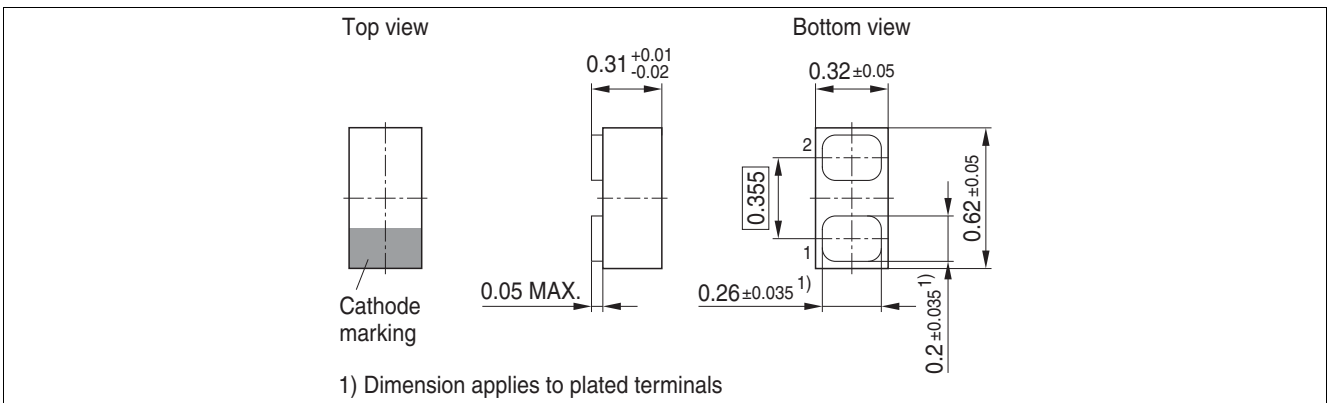

Figure 9 TSSLP-2-4 Package outline

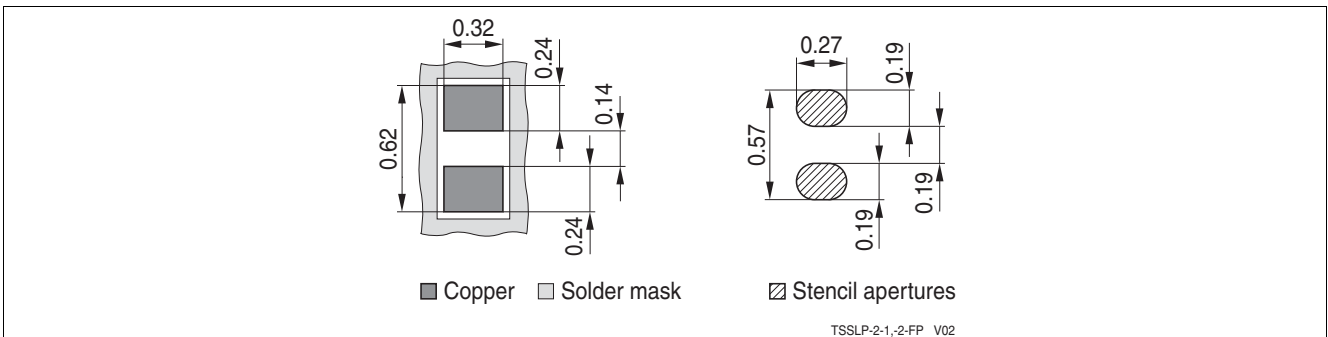

Figure 10 TSSLP-2-4 Footprint

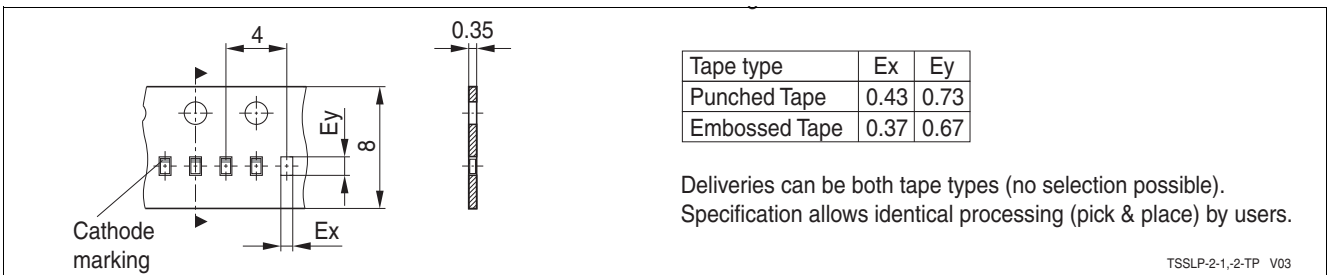

Figure 11 TSSLP-2-4 Packing

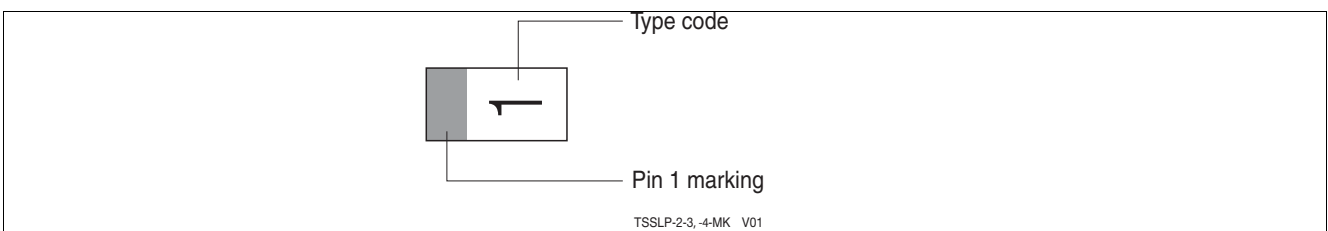

Figure 12 TSSLP-2-4 Marking (example)

4.2 TSLP-2-20 [2]

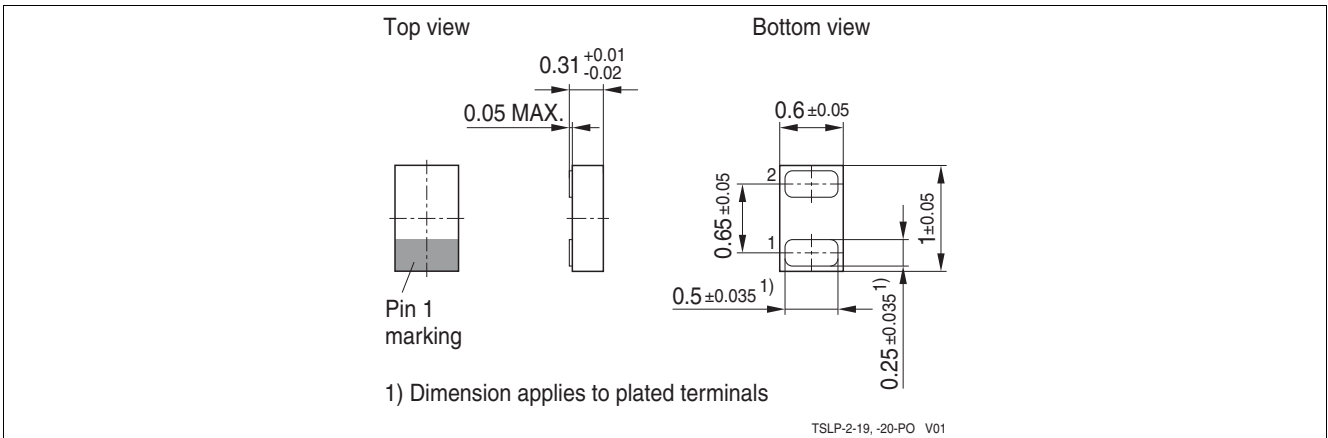

Figure 13 TSLP-2-20 Package outline

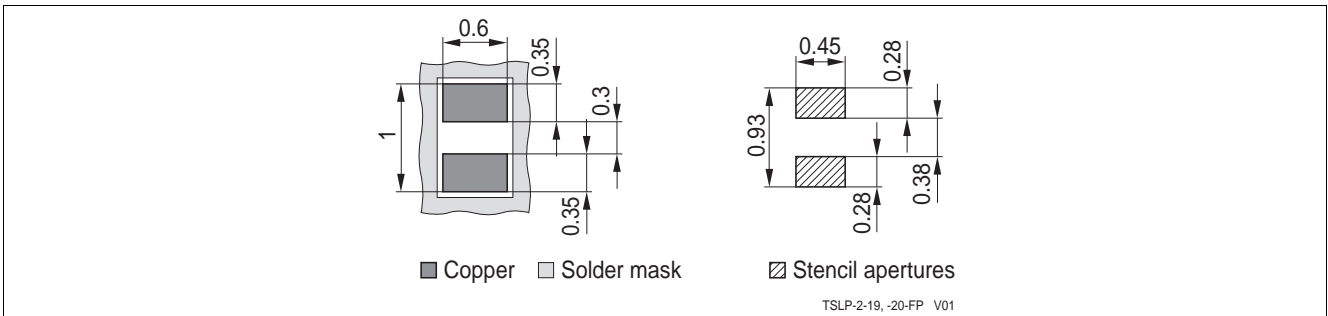

Figure 14 TSLP-2-20 Footprint

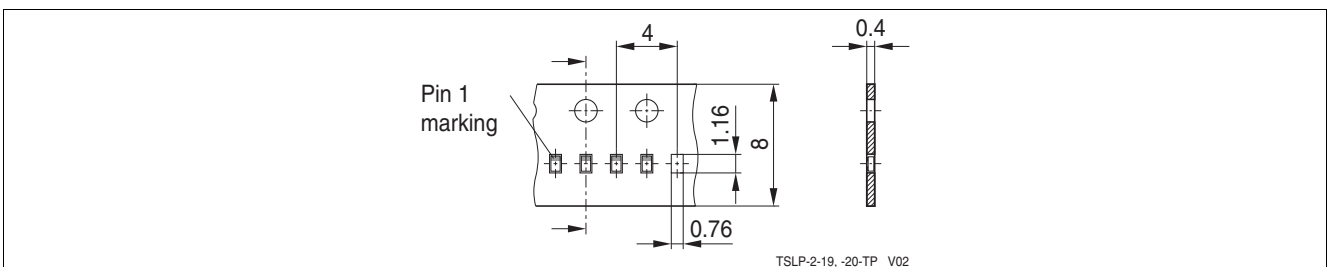

Figure 15 TSLP-2-20 Packing

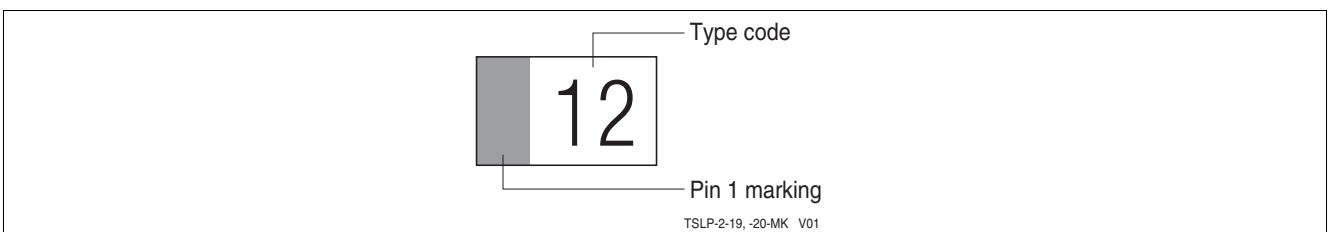

Figure 16 TSLP-2-20 Marking (example)



References

- [1] Infineon AG - **Application Note AN210**: Effective ESD Protection Design at System Level using VF-TLP Characterization Methodology
- [2] Infineon AG - Recommendations for PCB Assembly of Infineon TSLP and TSSLP Packages
- [3] Tero, Ranta, Juha Ellä, Helena Pohjonen: Antenna Switch Linearity Requirements for GSM/WCDMA Mobile Phone Front-Ends. Nokia Technology Platforms, P.O.Box 86, FIN-24101 SALO.
- [4] Infineon AC - Application Note AN327: ESD101-B1 / ESD103-B1, Bi-directional Ultra Low Capacitance Transient Voltage Suppression Diodes for High Power RF Applications.



Revision History: Revision 1.2, 2013-07-22

Page or Item	Subjects (major changes since previous revision)
Revision 1.3, 2014-06-12	
6	Table 5) updated

Trademarks of Infineon Technologies AG

AURIX™, BlueMoon™, COMNEON™, C166™, CROSSAVE™, CanPAK™, CIPOS™, CoolMOS™, CoolSET™, CORECONTROL™, DAVE™, EasyPIM™, EconoBRIDGE™, EconoDUAL™, EconoPACK™, EconoPIM™, EiceDRIVER™, EUPEC™, FCOS™, HITFET™, HybridPACK™, ISOFACE™, I²RF™, IsoPACK™, MIPAQ™, ModSTACK™, my-d™, NovalithIC™, OmniTune™, OptiMOS™, ORIGA™, PROFET™, PRO-SIL™, PRIMARION™, PrimePACK™, RASIC™, ReverSave™, SatRIC™, SIEGET™, SINDRION™, SMARTi™, SmartLEWIS™, TEMPFET™, thinQ!™, TriCore™, TRENCHSTOP™, X-GOLD™, XMM™, X-PMU™, XPOSSYS™.

Other Trademarks

Advance Design System™ (ADS) of Agilent Technologies, AMBA™, ARM™, MULTI-ICE™, PRIMECELL™, REALVIEW™, THUMB™ of ARM Limited, UK. AUTOSAR™ is licensed by AUTOSAR development partnership. Bluetooth™ of Bluetooth SIG Inc. CAT-iq™ of DECT Forum. COLOSSUS™, FirstGPS™ of Trimble Navigation Ltd. EMV™ of EMVCo, LLC (Visa Holdings Inc.). EPCOS™ of Epcos AG. FLEXGO™ of Microsoft Corporation. FlexRay™ is licensed by FlexRay Consortium. HYPERTERMINAL™ of Hilgraeve Incorporated. IEC™ of Commission Electrotechnique Internationale. IrDA™ of Infrared Data Association Corporation. ISO™ of INTERNATIONAL ORGANIZATION FOR STANDARDIZATION. MATLAB™ of MathWorks, Inc. MAXIM™ of Maxim Integrated Products, Inc. MICROTEC™, NUCLEUS™ of Mentor Graphics Corporation. Mifare™ of NXP. MIPI™ of MIPI Alliance, Inc. MIPS™ of MIPS Technologies, Inc., USA. muRata™ of MURATA MANUFACTURING CO., MICROWAVE OFFICE™ (MWO) of Applied Wave Research Inc., OmniVision™ of OmniVision Technologies, Inc. Openwave™ Openwave Systems Inc. RED HAT™ Red Hat, Inc. RFMD™ RF Micro Devices, Inc. SIRIUS™ of Sirius Sattelite Radio Inc. SOLARIS™ of Sun Microsystems, Inc. SPANSION™ of Spansion LLC Ltd. Symbian™ of Symbian Software Limited. TAIYO YUDEN™ of Taiyo Yuden Co. TEAKLITE™ of CEVA, Inc. TEKTRONIX™ of Tektronix Inc. TOKO™ of TOKO KABUSHIKI KAISHA TA. UNIX™ of X/Open Company Limited. VERILOG™, PALLADIUM™ of Cadence Design Systems, Inc. VLYNQ™ of Texas Instruments Incorporated. VXWORKS™, WIND RIVER™ of WIND RIVER SYSTEMS, INC. ZETEX™ of Diodes Zetex Limited.

Last Trademarks Update 2010-06-09

