

Excellent Integrated System Limited

Stocking Distributor

Click to view price, real time Inventory, Delivery & Lifecycle Information:

[Vishay Semiconductor/Diodes Division](#)
[UFB200FA40](#)

For any questions, you can email us directly:

sales@integrated-circuit.com

International IOR Rectifier

UFB200FA40

Ultrafast Soft Recovery Diode

Features

- Fast Recovery Time Characteristic
- Electrically Isolated Base Plate
- Large Creepage Distance Between Terminal
- Simplified Mechanical Designs, Rapid Assembly

$$V_R = 400V$$

$$V_F(\text{typ.}) = 1.0V$$

$$I_{F(AV)} = 200A$$

Description

The dual diode series configuration (UFB200FA40) is used for output rectification or freewheeling/clamping operation and high voltage application. The semiconductor in the SOT-227 package is isolated from the copper base plate, allowing for common heatsinks and compact assemblies to be built. These modules are intended for general applications such as HV power supplies, HF welders, motor control and inverters.

Absolute Maximum Ratings

Parameters	Max	Units
V_R Cathode-to-Anode Voltage	400	V
I_F Continuous Forward Current, $T_C = 100^\circ\text{C}$ Per Leg	100	A
I_{FSM} Single Pulse Forward Current, $T_C = 25^\circ\text{C}$ Per Leg	1300	
I_{FRM} Maximum Repetitive Forward Current Per Leg	260	
Max. Power Dissipation, $T_C @ 90^\circ\text{C}$ Per Module	240	W
V_{ISOL} RMS Isolation Voltage, Any Terminal to Case, $t = 1 \text{ min}$	2500	V
T_J, T_{STG} Operating Junction and Storage Temperatures	- 55 to 150	$^\circ\text{C}$

Case Styles

UFB200FA40

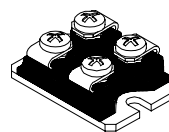

SOT-227

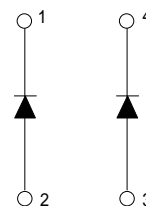

UFB200FA40

Preliminary Data Sheet PD-20486 rev. A 04/01

 International

Electrical Characteristics @ T_J = 25°C (unless otherwise specified) per diode

Parameters	Min	Typ	Max	Units	Test Conditions
V _{BR} Cathode Anode Breakdown Voltage	400	-	-	V	I _R = 100μA
V _{FM} Forward Voltage	-	-	1.2	V	I _F = 100A
	-	-	1.0	V	I _F = 100A, T _J = 150°C
I _{RM} Reverse Leakage Current	-	-	50	μA	V _R = V _R Rated
	-	-	4	mA	T _J = 150°C, V _R = V _R Rated
C _T Junction Capacitance	-	100	-	pF	V _R = 400V

Dynamic Recovery Characteristics @ T_J = 25°C (unless otherwise specified) per diode

Parameters	Min	Typ	Max	Units	Test Conditions
t _{rr} Reverse Recovery Time	-	-	60	ns	I _F = 1.0A, di _F /dt = 200A/μs, V _R = 30V
	-	93	-		T _J = 25°C
	-	172	-		T _J = 125°C
I _{RRM} Peak Recovery Current	-	11	-	A	T _J = 25°C
	-	20	-		T _J = 125°C
Q _{rr} Reverse Recovery Charge	-	490	-	nC	T _J = 25°C
	-	1740	-		T _J = 125°C

Thermal - Mechanical Characteristics

Parameters	Min	Typ	Max	Units
R _{thJC} Junction to Case, Single Leg Conducting Both Leg Conducting			0.5	°C/W
			0.25	K/W
R _{thCS} Case to Heat Sink, Flat, Greased Surface		0.05		
Wt Weight		30		g
T Mounting Torque		1.3		(N*m)

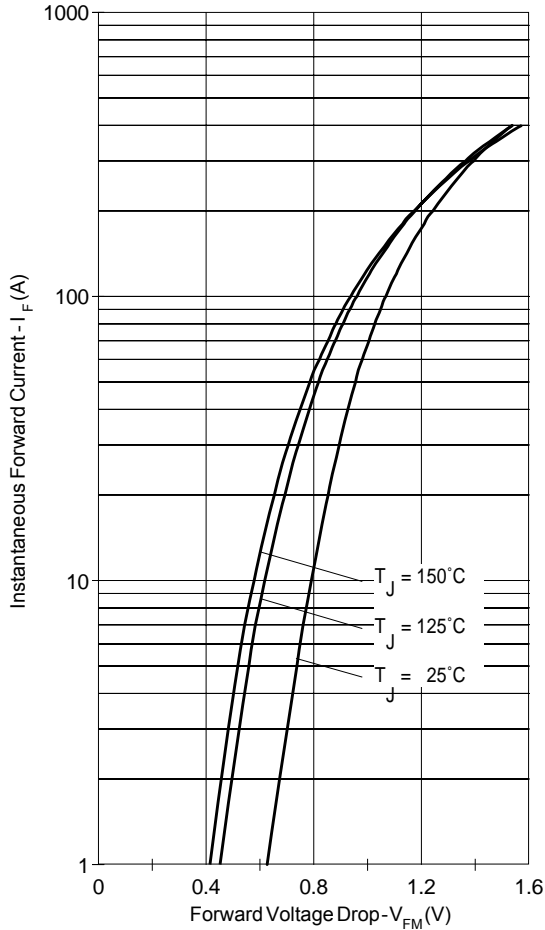

Fig. 1 - Typical Forward Voltage Drop Characteristics (per diode)

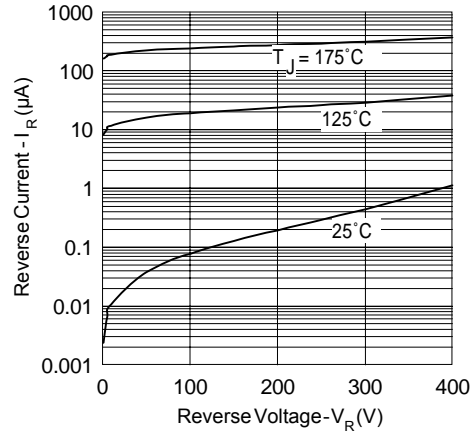

Fig. 2 - Typical Values Of Reverse Current Vs. Reverse Voltage

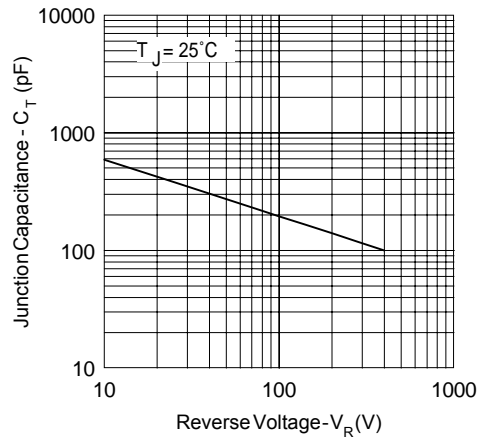

Fig. 3 - Typical Junction Capacitance Vs. Reverse Voltage

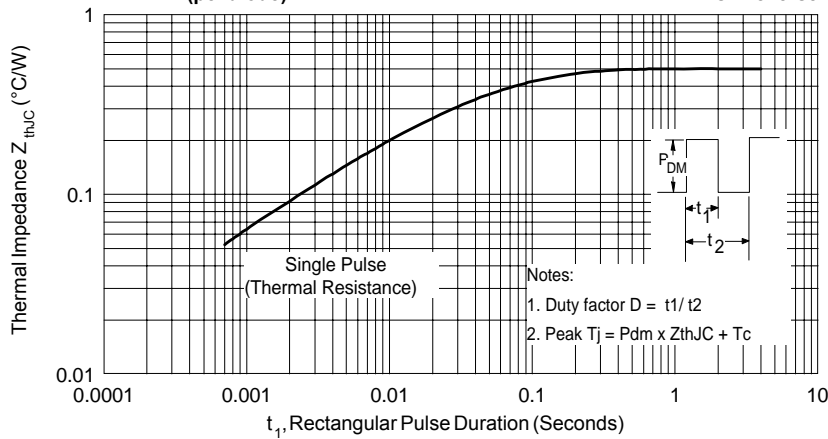

Fig. 4 - Max. Thermal Impedance Z_{thJC} Characteristics (per diode)

UFB200FA40

Preliminary Data Sheet PD-20486 rev. A 04/01

International
IR Rectifier

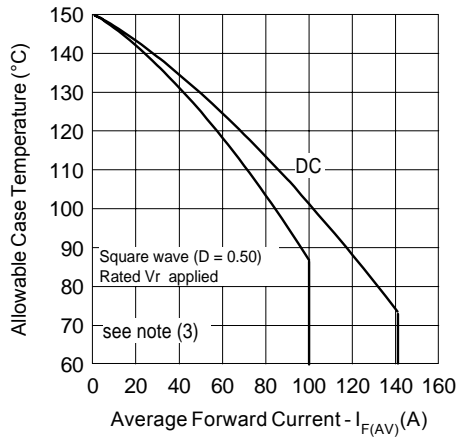

Fig. 5 - Max. Allowable Case Temperature Vs. Average Forward Current (per leg)

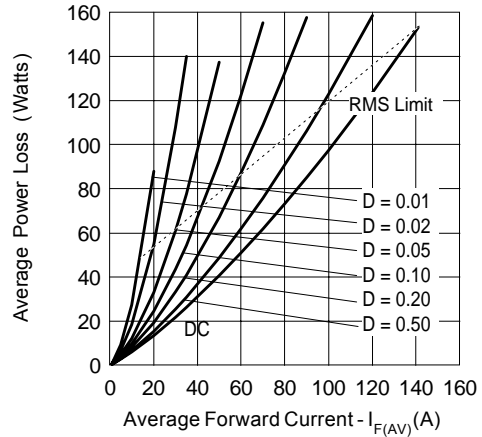

Fig. 6 - Forward Power Loss Characteristics (per leg)

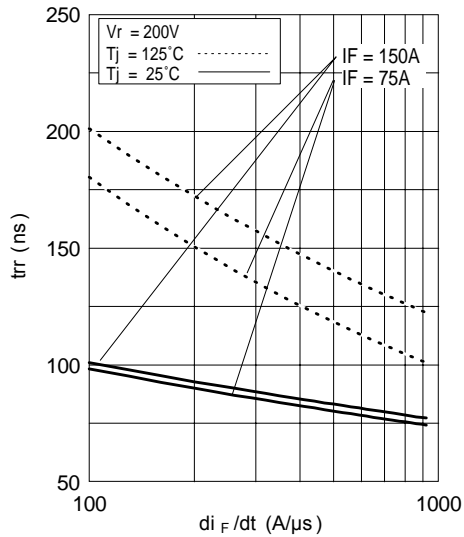

Fig. 7 - Typical Reverse Recovery time vs. di_F/dt

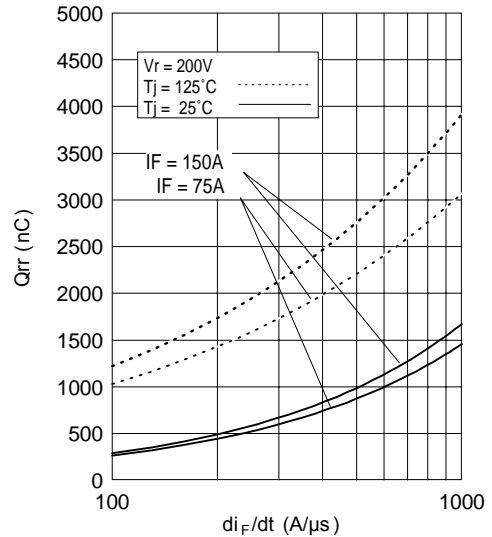

Fig. 8 - Typical Stored Charge vs. di_F/dt

(3) Formula used: $T_C = T_J - (P_d + P_{d_{REV}}) \times R_{thJC}$;

P_d = Forward Power Loss = $I_{F(AV)} \times V_{FM} @ (I_{F(AV)} / D)$ (see Fig. 6);

$P_{d_{REV}}$ = Inverse Power Loss = $V_{R1} \times I_R (1 - D)$; $I_R @ V_{R1} = 80\%$ rated V_R

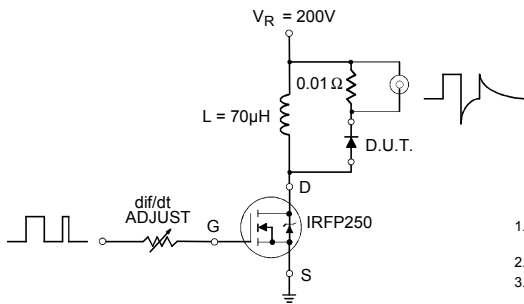
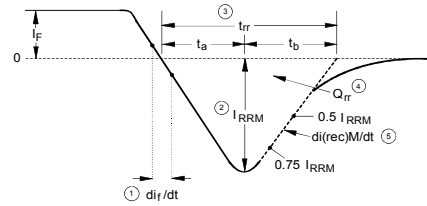

Fig. 1 - Reverse Recovery Parameter Test Circuit



1. di_f/dt - Rate of change of current through zero crossing
2. I_{RRM} - Peak reverse recovery current
3. t_{rr} - Reverse recovery time measured from zero crossing point of negative going I_F to point where a line passing through $0.75 I_{RRM}$ and $0.5 I_{RRM}$ extrapolated to zero current
4. Q_{rr} - Area under curve defined by t_{rr} and I_{RRM}

$$Q_{rr} = \frac{t_{rr} \times I_{RRM}}{2}$$
5. $di_{(rec)M}/dt$ - Peak rate of change of current during t_b portion of t_{rr}

Fig. 2 - Reverse Recovery Waveform and Definitions

SOT-227 Package Details

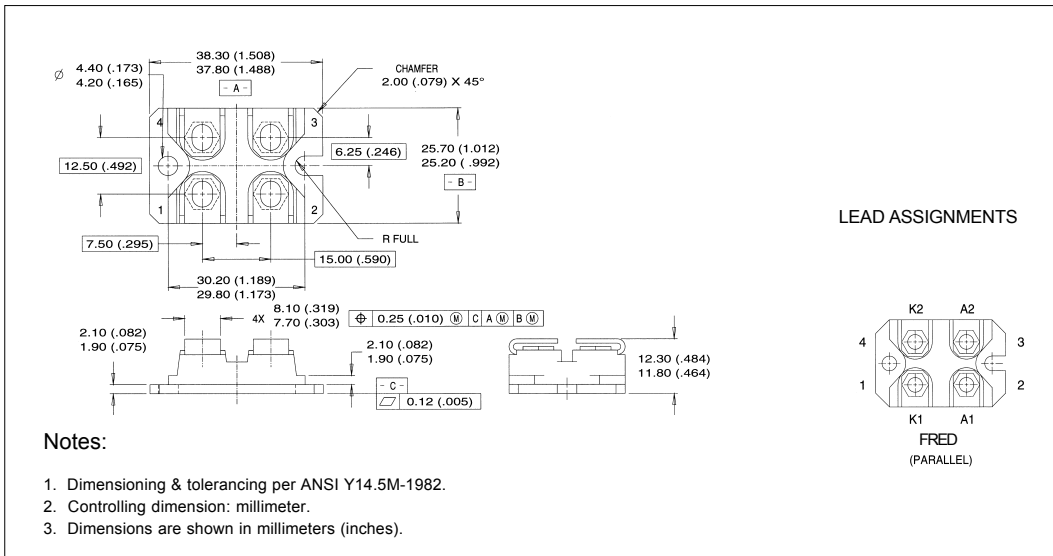

UFB200FA40

Preliminary Data Sheet PD-20486 rev. A 04/01

International
IR Rectifier

SOT-227 Package Details

Tube

QUANTITIES PER TUBE IS 10
M4 SCREW AND WASHER INCLUDED

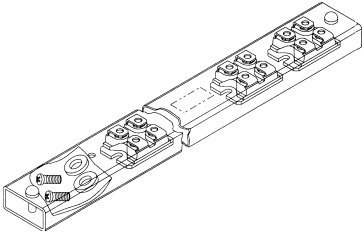

Ordering Information Table

Device Code

UF	B	200	F	A	40	-
①	②	③	④	⑤	⑥	⑦

1	-	ULTRAFast RECTIFIER	
2	-	Ultrafast Pt diffused	
3	-	Current Rating	(200 = 200A)
4	-	Circuit Configuration	(2 separate Diodes, parallel pin-out)
5	-	Package Indicator	(SOT-227 Standard Isolated Base)
6	-	Voltage Rating	(40 = 400V)
7	-	Special Options	

Empty = No special Option
LC = n.a.

Data and specifications subject to change without notice.
This product has been designed and qualified for Industrial Level.
Qualification Standards can be found on IR's Web site.

International
IR Rectifier

IR WORLD HEADQUARTERS: 233 Kansas St., El Segundo, California 90245, USA Tel: (310) 252-7105
TAC Fax: (310) 252-7309
Visit us at www.irf.com for sales contact information. 04/01