

Excellent Integrated System Limited

Stocking Distributor

Click to view price, real time Inventory, Delivery & Lifecycle Information:

[Vishay/Siliconix](#)
[VQ3001P-E3](#)

For any questions, you can email us directly:

sales@integrated-circuit.com



VQ3001J/P
Vishay Siliconix

Dual N-/Dual P-Channel 30-V (D-S) MOSFETs

PRODUCT SUMMARY				
	$V_{(BR)DSS}$ Min (V)	$r_{DS(on)}$ Max (Ω)	$V_{GS(th)}$ (V)	I_D (A)
N-Channel	30	1 @ $V_{GS} = 12$ V	0.8 to 2.5	0.85
P-Channel	-30	2 @ $V_{GS} = -12$ V	-2 to -4.5	-0.6

FEATURES

- Low On-Resistance: 0.8/1.6 Ω
- Low Threshold: 1.5/-3.1 V
- Low Input Capacitance: 38/60 pF
- Fast Switching Speed: 9/16 ns
- Low Input and Output Leakage

BENEFITS

- Low Offset Voltage
- Low-Voltage Operation
- Easily Driven Without Buffer
- High-Speed Circuits
- Low Error Voltage

APPLICATIONS

- Direct Logic-Level Interface: TTL/CMOS
- Drivers: Relays, Solenoids, Lamps, Hammers, Displays, Memories, Transistors, etc.
- Battery Operated Systems
- Solid-State Relays

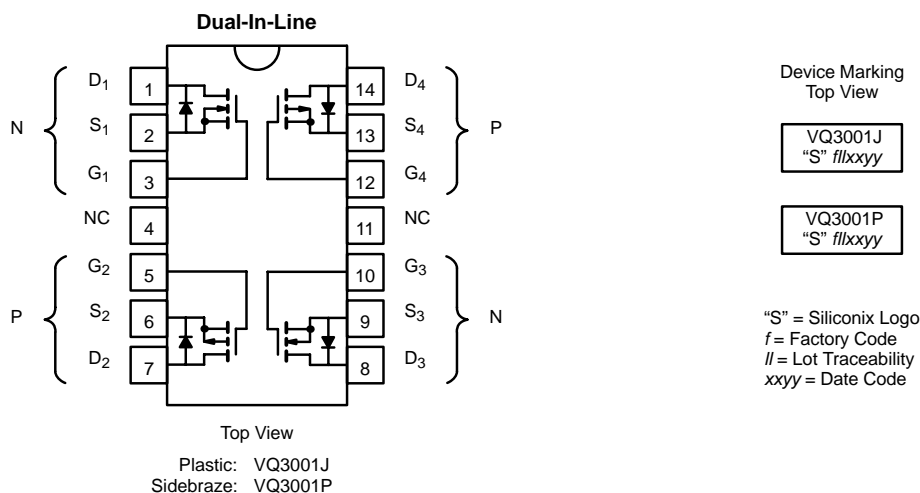

ABSOLUTE MAXIMUM RATINGS ($T_A = 25^\circ\text{C}$ UNLESS OTHERWISE NOTED)						
Parameter	Symbol	Single		Total Quad	Unit	
		N-Channel	P-Channel			
Drain-Source Voltage	V_{DS}	30	30			
Gate-Source Voltage	V_{GS}	VQ3001J	± 20			V
		VQ3001P	± 20			
Continuous Drain Current ($T_J = 150^\circ\text{C}$)	I_D	$T_A = 25^\circ\text{C}$	0.85	-0.6		A
		$T_A = 100^\circ\text{C}$	0.52	-0.37		
Pulsed Drain Current ^a	I_{DM}	3	-2			
Power Dissipation	P_D	$T_A = 25^\circ\text{C}$	1.3	1.3	2	W
		$T_A = 100^\circ\text{C}$	0.52	0.52	0.8	
Thermal Resistance, Junction-to-Ambient	R_{thJA}	96.2	96.2	62.5		$^\circ\text{C/W}$
Operating Junction and Storage Temperature Range	T_J, T_{stg}	-55 to 150	-55 to 150			$^\circ\text{C}$

Notes

a. Pulse width limited by maximum junction temperature.



VQ3001J/P

Vishay Siliconix

SPECIFICATIONS (T _A = 25 °C UNLESS OTHERWISE NOTED)								
Parameter	Symbol	Test Condition	Typ ^a	Limits				Unit
				N-Channel		P-Channel		
				Min	Max	Min	Max	
Static								
Drain-Source Breakdown Voltage	V _{(BR)DSS}	V _{GS} = 0 V, I _D = 10 μA	55	30				V
		V _{GS} = 0 V, I _D = -10 μA	-55			-30		
Gate-Source Threshold Voltage	V _{GS(th)}	V _{DS} = V _{GS} , I _D = 1 mA	1.5	0.8	2.5			V
		V _{DS} = V _{GS} , I _D = -1 mA	-3.1			-2	-4.5	
Gate-Body Leakage	I _{GSS}	V _{DS} = 0 V, V _{GS} = ±20 V			±100		±100	nA
		V _{DS} = 0 V, V _{GS} = ±20 V, T _J = 125 °C			±500		±500	
Zero-Gate Voltage Drain Current	I _{DSS}	V _{DS} = 24 V, V _{GS} = 0 V			10			μA
		V _{DS} = -24 V, V _{GS} = 0 V					-10	
		V _{DS} = 24 V, V _{GS} = 0 V, T _J = 125 °C			500			
		V _{DS} = -24 V, V _{GS} = 0 V, T _J = 125 °C					-500	
On-State Drain Current ^b	I _{D(on)}	V _{DS} = 10 V, V _{GS} = 12 V	3	2				A
		V _{DS} = -10 V, V _{GS} = -12 V	-2			-1.5		
Drain-Source On-State Resistance ^b	r _{DS(on)}	V _{GS} = 5 V, I _D = 0.2 A	1.2		1.75			Ω
		V _{GS} = 12 V, I _D = 1 A	0.81		1.0			
		V _{GS} = -12 V, I _D = -1 A	1.6				2.0	
		V _{GS} = 12 V, I _D = 1 A, T _J = 125 °C	1.65		2.0			
Forward Transconductance ^b	g _{fs}	V _{DS} = 10 V, I _D = 0.5 A	500	250				mS
		V _{DS} = -10 V, I _D = -0.5 A	390			200		
Dynamic								
Input Capacitance	C _{iss}	N-Channel V _{DS} = 15 V, V _{GS} = 0 V, f = 1 MHz P-Channel V _{DS} = -15 V, V _{GS} = 0 V, f = 1 MHz	38		110			pF
Output Capacitance	C _{oss}		60				150	
			33		110			
Reverse Transfer Capacitance	C _{rss}		45				100	
			8		35			
Turn-On Time	t _{ON}		N-Channel V _{DD} = 15 V, R _L = 23 Ω I _D ≅ 0.6 A, V _{GEN} = 10 V, R _G = 25 Ω	9		30		
		19				30		
Turn-Off Time	t _{OFF}	P-Channel V _{DD} = -15 V, R _L = 23 Ω I _D ≅ -0.6 A, V _{GEN} = -10 V, R _G = 25 Ω	14		30			
		16				30		

Notes

- a. For DESIGN AID ONLY, not subject to production testing.
- b. Pulse test: PW ≤ 300 μs duty cycle ≤ 2%.

VNDQ03/VPEA03



VQ3001J/P
Vishay Siliconix

TYPICAL CHARACTERISTICS (T_A = 25°C UNLESS OTHERWISE NOTED) N-CHANNEL

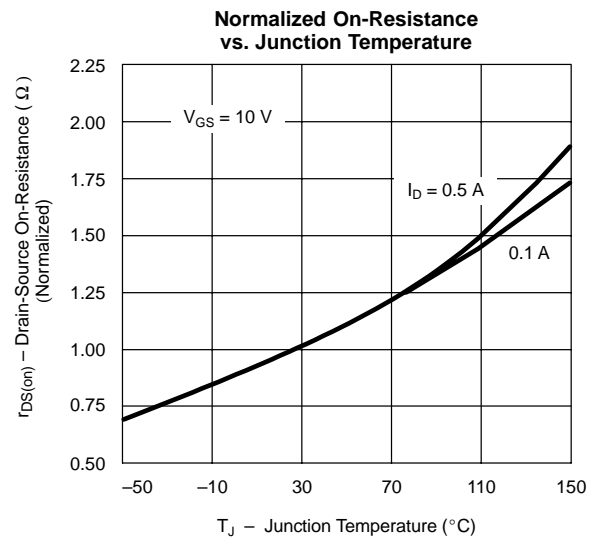
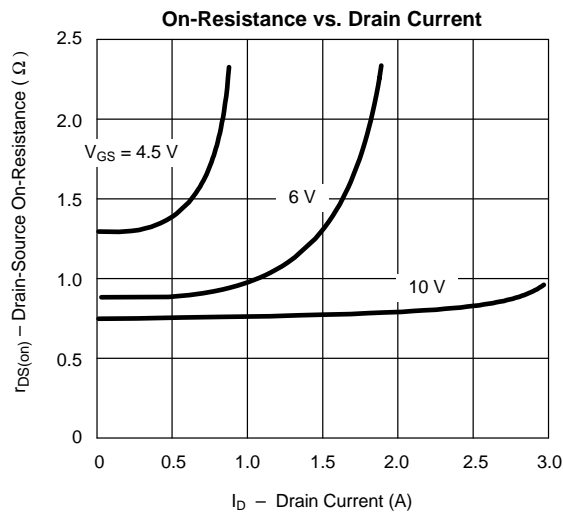
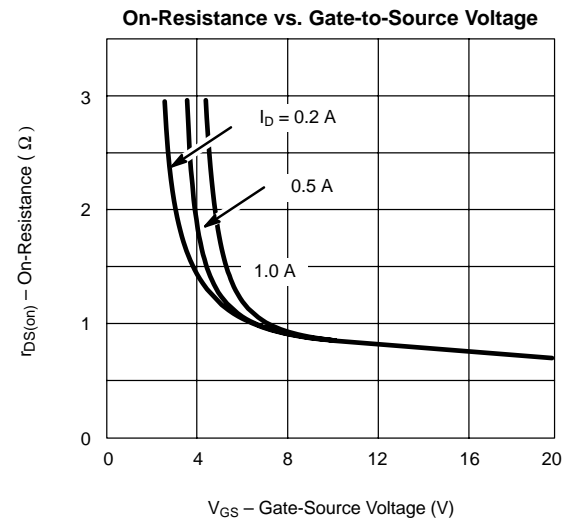
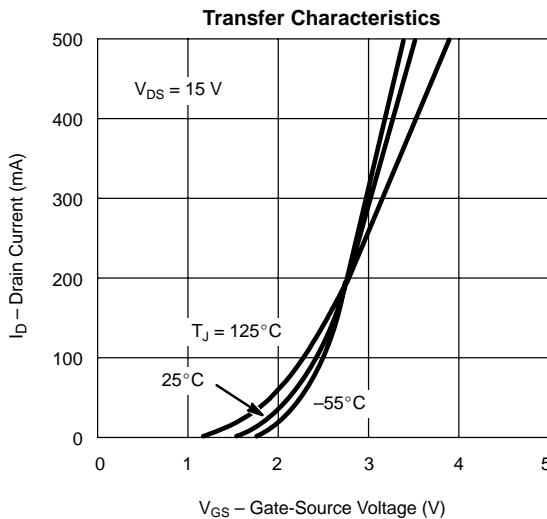
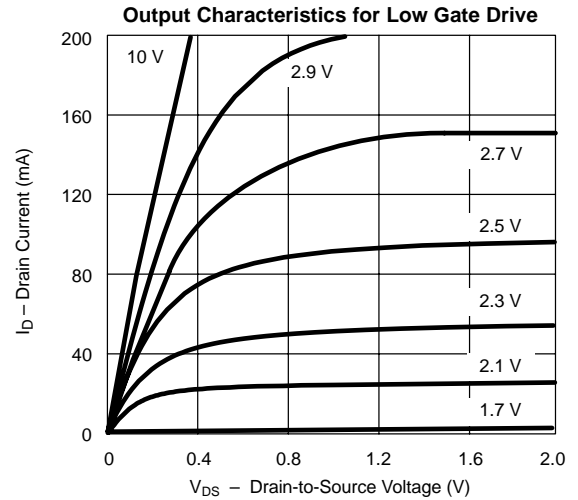
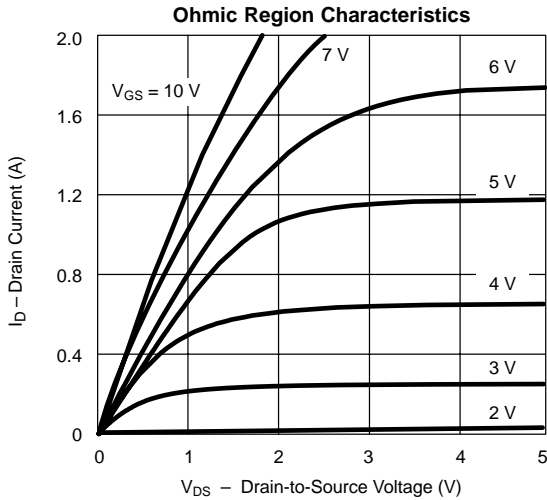



VQ3001J/P

Vishay Siliconix

TYPICAL CHARACTERISTICS (T_A = 25 °C UNLESS OTHERWISE NOTED)

N-CHANNEL

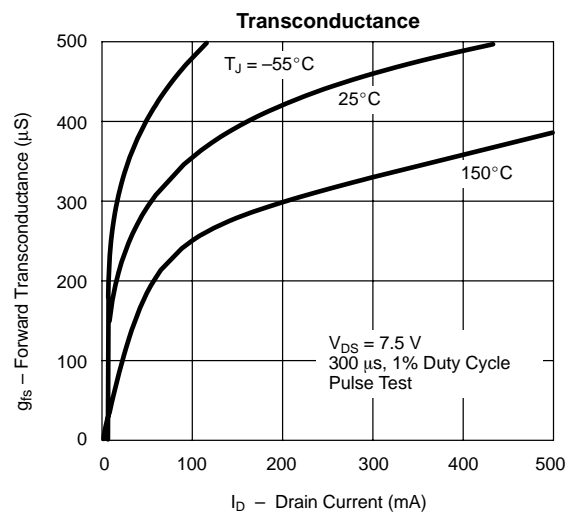
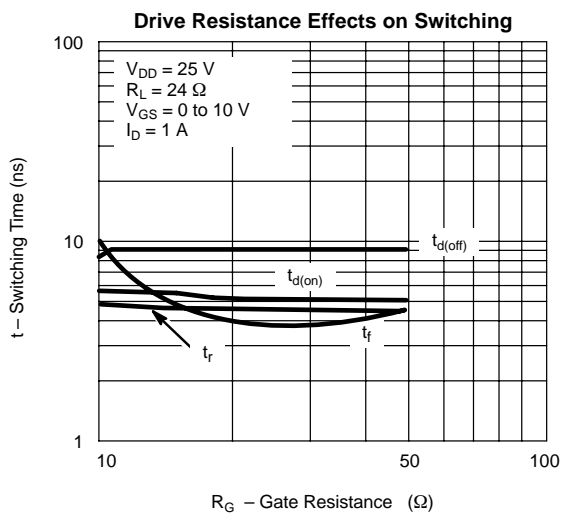
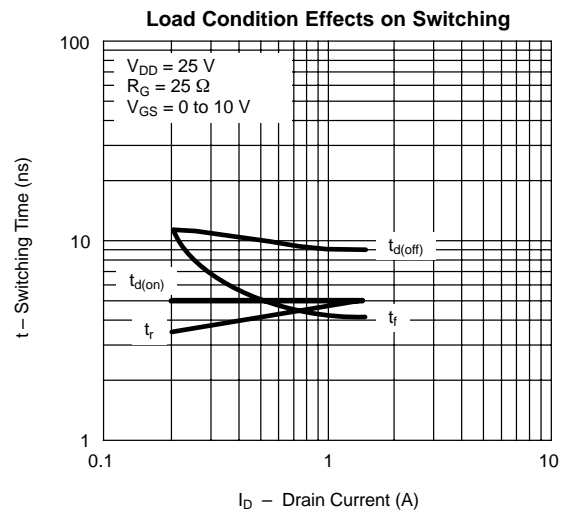
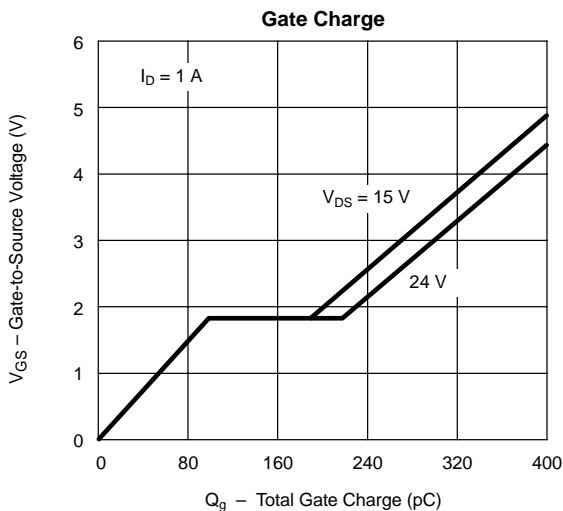
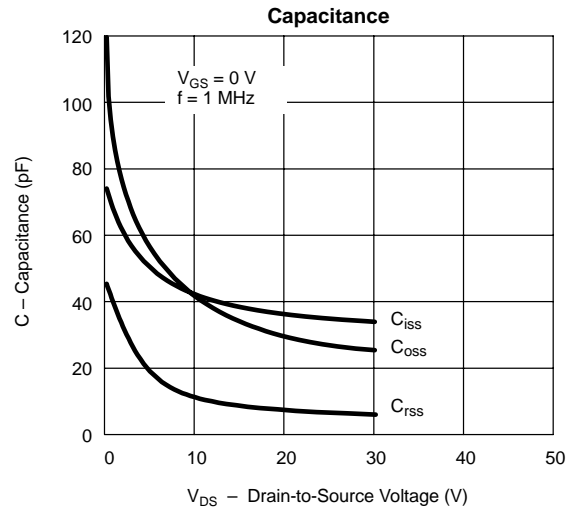
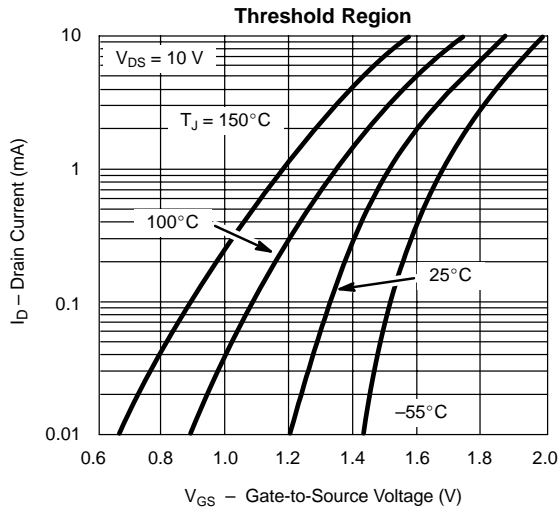



VQ3001J/P
Vishay Siliconix

TYPICAL CHARACTERISTICS (T_A = 25 °C UNLESS OTHERWISE NOTED) P-CHANNEL

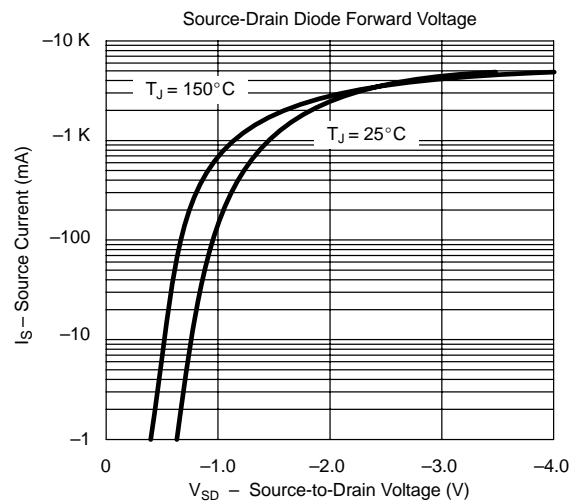
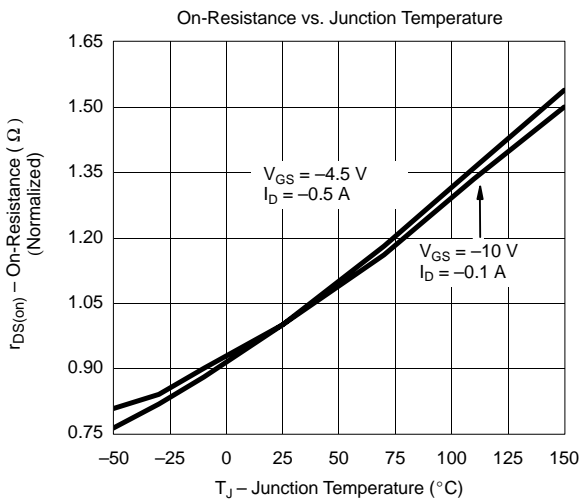
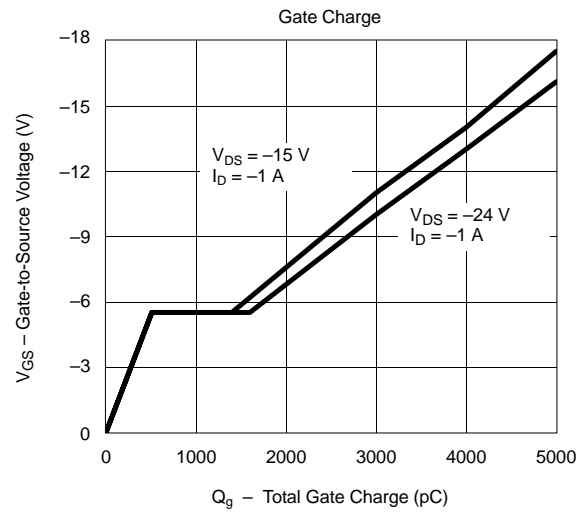
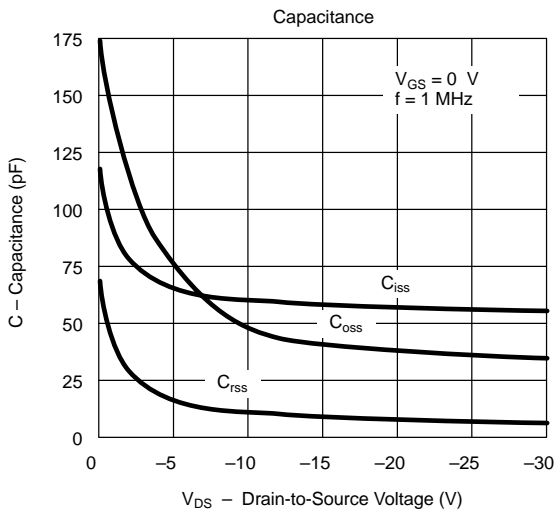
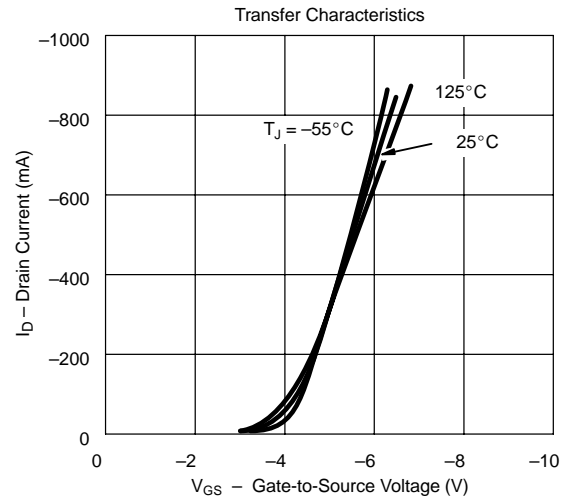
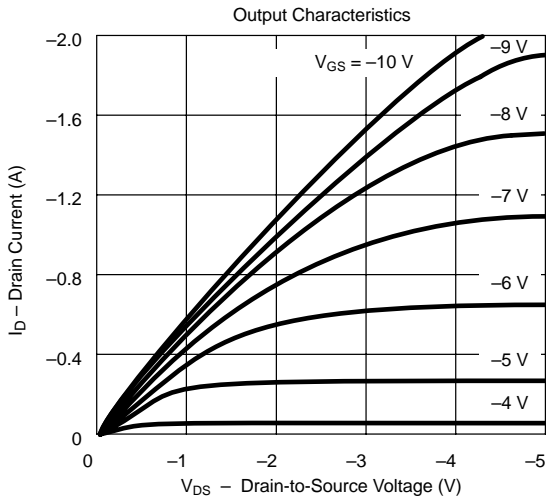



VQ3001J/P

Vishay Siliconix

TYPICAL CHARACTERISTICS (T_A = 25 °C UNLESS OTHERWISE NOTED) P-CHANNEL

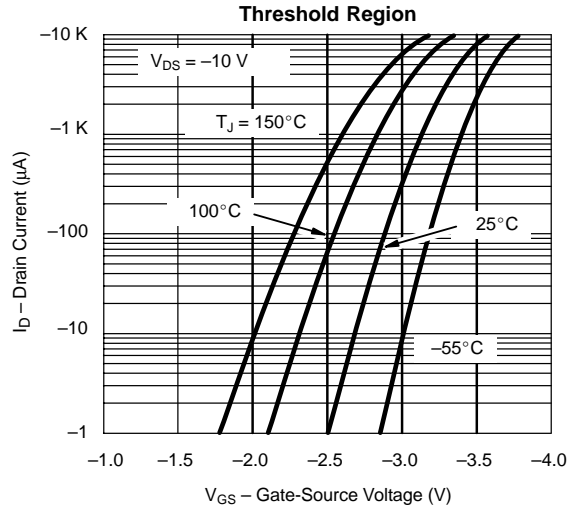
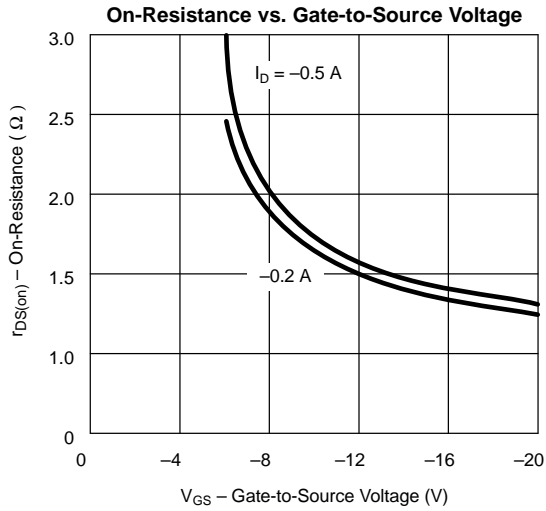



Legal Disclaimer Notice

Vishay

Disclaimer

All product specifications and data are subject to change without notice.

Vishay Intertechnology, Inc., its affiliates, agents, and employees, and all persons acting on its or their behalf (collectively, "Vishay"), disclaim any and all liability for any errors, inaccuracies or incompleteness contained herein or in any other disclosure relating to any product.

Vishay disclaims any and all liability arising out of the use or application of any product described herein or of any information provided herein to the maximum extent permitted by law. The product specifications do not expand or otherwise modify Vishay's terms and conditions of purchase, including but not limited to the warranty expressed therein, which apply to these products.

No license, express or implied, by estoppel or otherwise, to any intellectual property rights is granted by this document or by any conduct of Vishay.

The products shown herein are not designed for use in medical, life-saving, or life-sustaining applications unless otherwise expressly indicated. Customers using or selling Vishay products not expressly indicated for use in such applications do so entirely at their own risk and agree to fully indemnify Vishay for any damages arising or resulting from such use or sale. Please contact authorized Vishay personnel to obtain written terms and conditions regarding products designed for such applications.

Product names and markings noted herein may be trademarks of their respective owners.