

## Excellent Integrated System Limited

Stocking Distributor

Click to view price, real time Inventory, Delivery & Lifecycle Information:

[Molex Connector Corporation](#)  
[0764551107](#)

For any questions, you can email us directly:

[sales@integrated-circuit.com](mailto:sales@integrated-circuit.com)

13 12 11 10 9 8 7 6 5 4 3 2 1

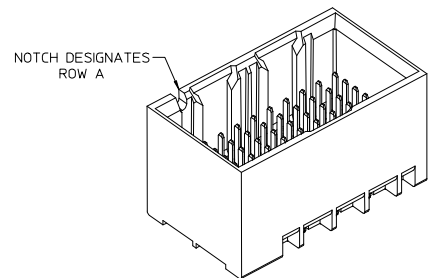
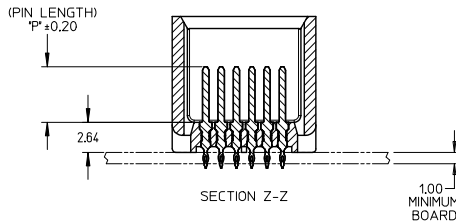
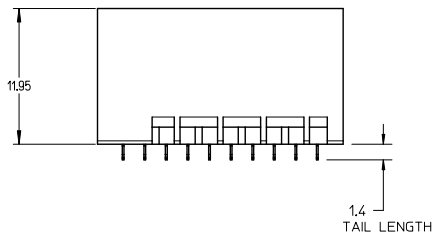
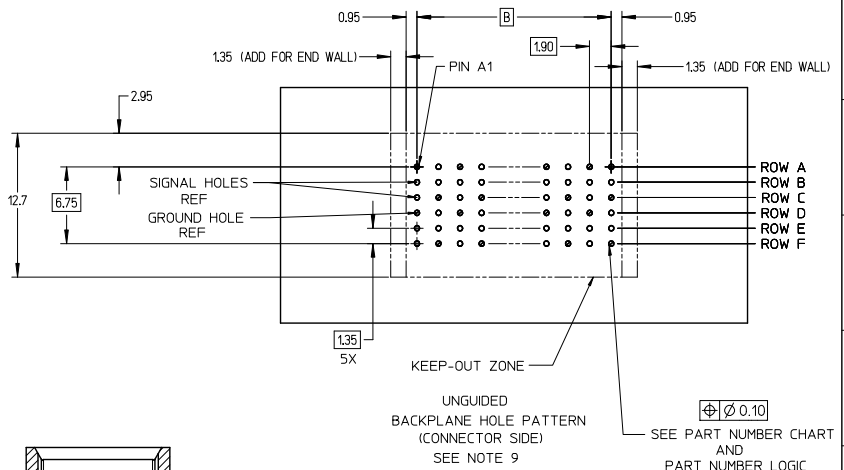
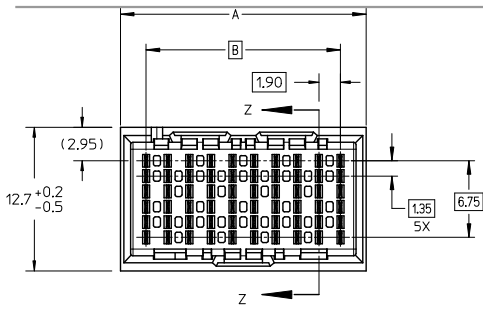

- NOTES:
1. MATERIALS: HOUSING - LIQUID CRYSTAL POLYMER (LCP)  
GLASS-FILLED, UL94V-0  
TERMINALS - HIGH PERFORMANCE COPPER ALLOY
  2. FINISH: 30μ MIN GOLD IN CONTACT AREA,  
SELECTIVE TIN ON PCB TAILS,  
NICKEL OVERALL.
  3. REFER TO MOLEX PRODUCT SPECIFICATION PS-76060-999 FOR  
PERFORMANCE SPECIFICATIONS AND ADDITIONAL PCB INFORMATION.
  4. THIS PART CONFORMS TO CLASS B REQUIREMENTS OF  
MOLEX COSMETIC SPEC PS-45499-002.
  5. PARTS PACKAGED PER PK-70873-7704.
  6. SEE SHEETS 2 & 3 FOR PART NUMBERS AND BOARD RELATIONSHIPS.
  7. MATES WITH IMPACT DC SERIES NO. 76460.
  8. REFER TO MOLEX PCB ROUTING GUIDE AS-76060-990 FOR ANTIPAD AND  
ROUTING RECOMMENDATIONS.
  9. \*THESE DIMENSIONS REPRESENT THE AREA NEEDED TO ACCOMMODATE CONNECTOR  
INSERTION AND REPAIR ON THE PC BOARD. THIS IS REFERRED TO AS THE  
"CONNECTOR KEEP OUT ZONE" AND DOES NOT REPRESENT THE ACTUAL PERIMETER  
OF THE CONNECTOR, WHEN LAYING OUT A PC BOARD FOR CONNECTORS STACKED  
TOGETHER, USE A 1.9mm PROGRESSION.\*

CONVERT TO LEAD-FREE EC NO: UCP2015-2078 DRAWN: IBARRA 2012/12/17 CHKD: BINGHAM 2012/12/18 APPR: MILLER 2012/12/23 G REV	QUALITY SYMBOLS 	GENERAL TOLERANCES (UNLESS SPECIFIED)		DIMENSION STYLE <b>MM ONLY</b>		SCALE <b>4:1</b>	DESIGN UNITS <b>METRIC</b>	THIRD ANGLE PROJECTION	
		4 PLACES ± --- ± ---	3 PLACES ± --- ± ---	DRAWN BY MSANDBERG	DATE 2008/03/11	TITLE <b>IMPACT 2 PAIR HEADER          UNGUIDED ASSEMBLY          SALES DRAWING</b>   DOCUMENT NO. SD-76455-001 SHEET NO. 1 OF 3			
		2 PLACES ± 0.13 ± ---	1 PLACE ± 0.25 ± ---	CHECKED BY TELO	DATE 2008/03/11				
		0 PLACE ± --- ± ---	ANGULAR ± 1/2°	APPROVED BY JLAURX	DATE 2010/10/15				
DRAFT WHERE APPLICABLE MUST REMAIN WITHIN DIMENSIONS		MATERIAL NO. <b>SEE TABLE</b>	SIZE <b>C</b>						

PART NUMBER TABLE

MATERIAL NUMBER	# OF COLUMNS	# OF DIFF PAIR	DIM "A"	DIM "B"	DUAL END WALL OPTION
76455- <b>*12*</b>	10	20	21.7	17.10	
76455- <b>*62*</b>	16	32	33.1	28.50	

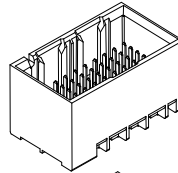

DUAL END  
WALL OPTION

MATERIAL NUMBER	# OF COLUMNS	# OF DIFF PAIR	DIM "A"	DIM "B"	LEFT END WALL OPTION
76455- <b>*11*</b>	10	20	20.3	17.10	
76455- <b>*61*</b>	16	32	31.7	28.50	

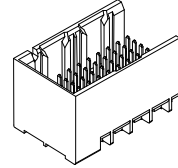

LEFT END  
WALL OPTION

MATERIAL NUMBER	# OF COLUMNS	# OF DIFF PAIR	DIM "A"	DIM "B"	RIGHT END WALL OPTION
76455- <b>*13*</b>	10	20	20.3	17.10	
76455- <b>*63*</b>	16	32	31.7	28.50	

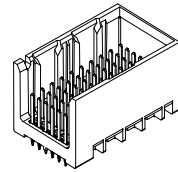

RIGHT END  
WALL OPTION

MATERIAL NUMBER	# OF COLUMNS	# OF DIFF PAIR	DIM "A"	DIM "B"	OPEN WALL OPTION
76455- <b>*10*</b>	10	20	18.9	17.10	
76455- <b>*60*</b>	16	32	30.3	28.50	

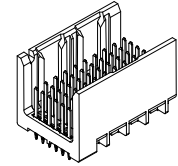

OPEN  
WALL OPTION

PART NUMBER LOGIC

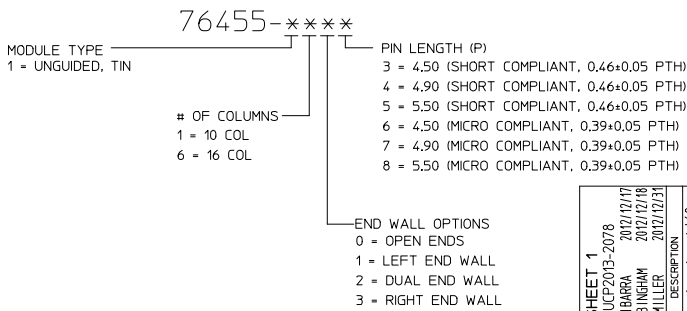

SEE SHEET 1 IEC NO: UCPE2015-2078 DRAWN: IBARRA CHKD: BINGHAM APPR: SMILLER	QUALITY SYMBOLS 	GENERAL TOLERANCES (UNLESS SPECIFIED)		DIMENSION STYLE MM ONLY		SCALE 2.5:1	DESIGN UNITS METRIC	THIRD ANGLE PROJECTION	
			mm	INCH	DRAWN BY MSANDBERG	DATE 2008/03/11	TITLE IMPACT 2 PAIR HEADER UNGUIDED ASSEMBLY SALES DRAWING 		
		4 PLACES ±	---	---	CHECKED BY TELO	DATE 2008/03/11			
		3 PLACES ±	---	---	APPROVED BY JLAURX	DATE 2010/10/15			
2 PLACES ±	0.13	---	MATERIAL NO. SD-76455-001	DOCUMENT NO. SD-76455-001					
1 PLACE ±	0.25	---	ANGULAR ±1/2°		DRAFT WHERE APPLICABLE MUST REMAIN WITHIN DIMENSIONS		SIZE C		
0 PLACE ±	---	---	THIS DRAWING CONTAINS INFORMATION THAT IS PROPRIETARY TO MOLEX INCORPORATED AND SHOULD NOT BE USED WITHOUT WRITTEN PERMISSION						

**IMPACT 2 PAIR  
BOARD RELATIONSHIPS**

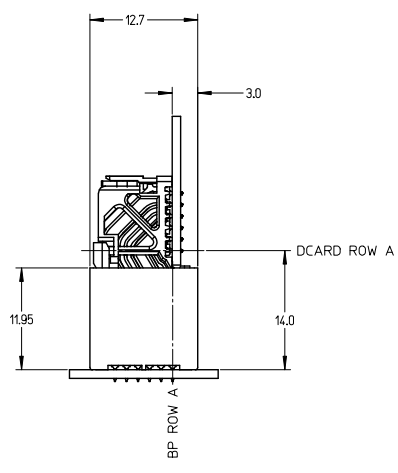
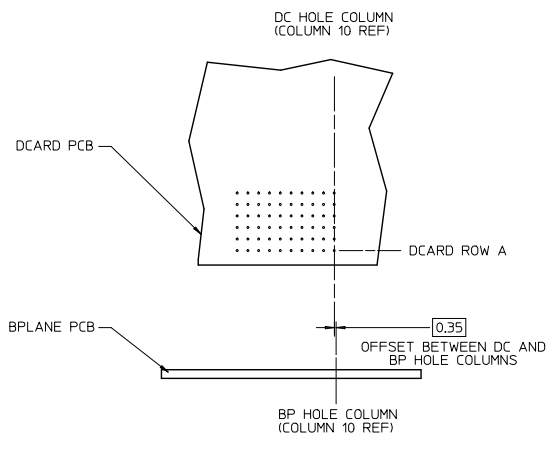
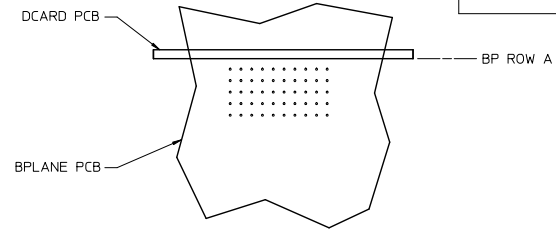

SEE SHEET 1 EC NO: UCP2015-2078 DRAWN BY: BARBARA 2012/12/17 CHECKED BY: BINGHAM 2012/12/18 APPROVED BY: MILLER 2012/12/31	QUALITY SYMBOLS ∇=0 ∇=0 ∇=0	GENERAL TOLERANCES (UNLESS SPECIFIED)		DIMENSION STYLE MM ONLY		SCALE 2:1	DESIGN UNITS METRIC	THIRD ANGLE PROJECTION		
		4 PLACES ±	mm	INCH	DRAWN BY	DATE	TITLE IMPACT 2 PAIR HEADER UNGUIDED ASSEMBLY SALES DRAWING <b>molex</b>			
		3 PLACES ±			CHECKED BY	DATE				
		2 PLACES ±0.13			APPROVED BY	DATE	MATERIAL NO.	DOCUMENT NO.	SHEET NO. 3 OF 3	
1 PLACE ±0.25			ANGULAR ±1/2°		SEE TABLE		SD-76455-001			
0 PLACE ±			DRAFT WHERE APPLICABLE MUST REMAIN WITHIN DIMENSIONS		THIS DRAWING CONTAINS INFORMATION THAT IS PROPRIETARY TO MOLEX INCORPORATED AND SHOULD NOT BE USED WITHOUT WRITTEN PERMISSION					