

## **Excellent Integrated System Limited**

Stocking Distributor

Click to view price, real time Inventory, Delivery & Lifecycle Information:

[Panduit](#)

[LCAX300-58H-6](#)

For any questions, you can email us directly:

[sales@integrated-circuit.com](mailto:sales@integrated-circuit.com)

THIS COPY IS PROVIDED ON A RESTRICTED BASIS AND IS NOT TO BE USED IN ANY WAY DETRIMENTAL TO THE INTERESTS OF PANDUIT CORP.

Material	High Conductivity Seamless Copper Tube
Plating	Electro-Tin
Wire Size	300 STR/FLEX
Wire Type	Stranded Copper: Class G, H, I, K, M, Locomotive
Wire Strip Length	1-1/4 in.
Stud Size	5/8 in.
UL Listed Wire Connector	Yes, for applications up to 35kv. Consult cable manufacturer for voltage stress relief instructions with applications greater than 2000 volts.
UL Temperature Rating	90 ° C
C.S.A Certified Wire Connector	Yes
Panduit Color Code on Barrel	RED
Panduit Die Index No. on Barrel	P71
Alternate Industry Die Index No. ( ) on Barrel	(18)

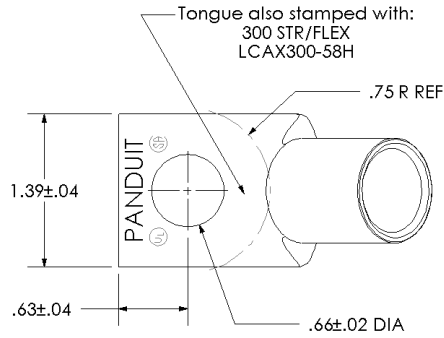

Color coded barrel markings

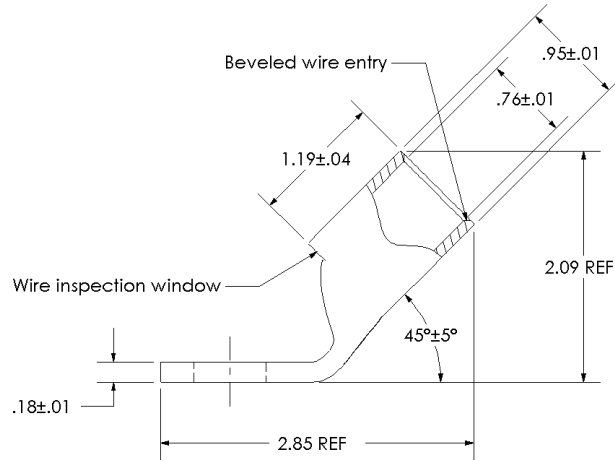

				<b>PANDUIT CORP. TINLEY PARK, ILLINOIS</b>	
				LCAX300-58H-6 Copper Lug - One-Hole, Standard Flex Barrel, 45° Angle Tongue	
00	6/03	CJW	SAC	RELEASED	10850
REV	DATE	BY	CHK	DESCRIPTION	ECN
					SCALE N/A
				DRAWING NO / CAD FILE	LCAX300-58H-CUST