

Excellent Integrated System Limited

Stocking Distributor

Click to view price, real time Inventory, Delivery & Lifecycle Information:

[Sharp Microelectronics](#)

[PC457L0NIP](#)

For any questions, you can email us directly:

sales@integrated-circuit.com

PC457L0NIP Series

High Speed 1Mb/s, High CMR
 Mini-flat Package
 *OPIC Photocoupler



■ Description

PC457L0NIP Series contains a LED optically coupled to an OPIC chip.

It is packaged in a 5 pin Mini-flat.

Input-output isolation voltage(rms) is 3.75 kV.

High speed response (TYP. 1Mb/s) and CMR is MIN. 15 kV/μs.

■ Features

1. Mini-flat 5 pin package
2. Double transfer mold package
(Ideal for Flow Soldering)
3. High speed response
(t_{PHL} : TYP. 0.2 μs, t_{PLH} : TYP. 0.4 μs)
4. High noise immunity due to high instantaneous common mode rejection voltage (CM_H : MIN. 15kV/μs, CM_L : MIN. -15kV/μs)
5. High isolation voltage between input and output
($V_{iso(rms)}$: 3.75 kV)

■ Agency approvals/Compliance

1. Recognized by UL1577 (Double protection isolation), file No. E64380 (as model No. **PC457L**)
2. Approved by VDE (VDE0884) (as an option), file No. 5911UG (as model No. **PC457L**)
3. Package resin : UL flammability grade (94V-0)

■ Applications

1. Programmable controller
2. Inverter

* "OPIC"(Optical IC) is a trademark of the SHARP Corporation. An OPIC consists of a light-detecting element and a signal-processing circuit integrated onto a single chip.

Notice The content of data sheet is subject to change without prior notice.

In the absence of confirmation by device specification sheets, SHARP takes no responsibility for any defects that may occur in equipment using any SHARP devices shown in catalogs, data books, etc. Contact SHARP in order to obtain the latest device specification sheets before using any SHARP device.

Internal Connection Diagram

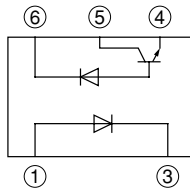

- ① Anode
- ③ Cathode
- ④ GND
- ⑤ V_O (Open collector)
- ⑥ V_{CC}

Outline Dimensions

(Unit : mm)

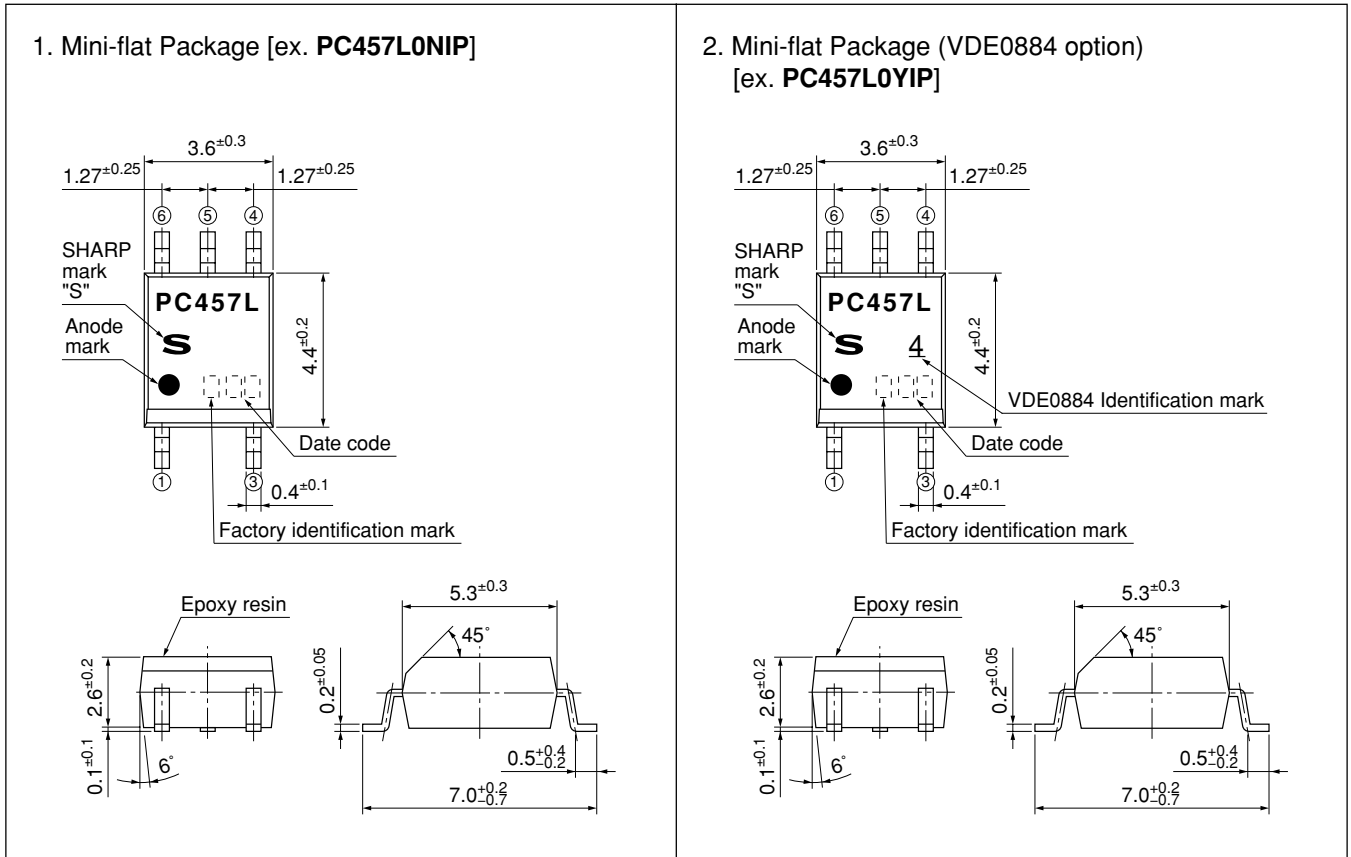





Product mass : approx. 0.1g

Date code (2 digit)

1st digit				2nd digit	
Year of production				Month of production	
A.D.	Mark	A.D.	Mark	Month	Mark
1990	A	2002	P	January	1
1991	B	2003	R	February	2
1992	C	2004	S	March	3
1993	D	2005	T	April	4
1994	E	2006	U	May	5
1995	F	2007	V	June	6
1996	H	2008	W	July	7
1997	J	2009	X	August	8
1998	K	2010	A	September	9
1999	L	2011	B	October	O
2000	M	2012	C	November	N
2001	N	∴	∴	December	D

repeats in a 20 year cycle

Factory identification mark

Factory identification Mark	Country of origin
no mark	Japan
	
	Indonesia
	Philippines
	China

* This factory marking is for identification purpose only.
Please contact the local SHARP sales representative to see the actual status of the production.

■ Absolute Maximum Ratings
 $(T_a=25^{\circ}\text{C})$

	Parameter	Symbol	Rating	Unit
Input	*1 Forward current	I_F	25	mA
	Reverse voltage	V_R	5	V
	*2 Power dissipation	P	45	mW
Output	Supply voltage	V_{CC}	-0.5 to +30	V
	Output voltage	V_O	-0.5 to +20	V
	Output current	I_O	8	mA
	*3 Power dissipation	P_O	100	mW
*3 Total power dissipation		P_{tot}	100	mW
Operating temperature		T_{opr}	-55 to +85	$^{\circ}\text{C}$
Storage temperature		T_{stg}	-55 to +125	$^{\circ}\text{C}$
*4 Isolation voltage		$V_{iso (rms)}$	3.75	kV
*5 Soldering temperature		T_{sol}	270	$^{\circ}\text{C}$

*1 When ambient temperature goes above 70 $^{\circ}\text{C}$, the power dissipation goes down at 0.8mA/ $^{\circ}\text{C}$. (Fig.3)

*2 When ambient temperature goes above 70 $^{\circ}\text{C}$, the power dissipation goes down at 1.5mW/ $^{\circ}\text{C}$. (Fig.4)

*3 When ambient temperature goes above 70 $^{\circ}\text{C}$, the power dissipation goes down at 1.8mW/ $^{\circ}\text{C}$. (Fig.4)

*4 40 to 60%RH, AC for 1minute, f=60Hz

*5 For 10s

■ Electro-optical Characteristics*7
 $(T_a=25^{\circ}\text{C})$

Parameter		Symbol	Conditions	MIN.	TYP.	MAX.	Unit	
Input	Forward voltage	V_F	$I_F=16\text{mA}$	-	1.7	1.95	V	
	Reverse current	I_R	$V_R=5\text{V}$	-	-	10	μA	
	Terminal capacitance	C_t	$V=0, f=1\text{MHz}$	-	60	250	pF	
Output	High level output current (1)	$I_{OH(1)}$	$I_F=0, V_{CC}=5.5\text{V}, V_O=5.5\text{V}$	-	3	500	nA	
	High level output current (2)	$I_{OH(2)}$	$I_F=0, V_{CC}=15\text{V}, V_O=15\text{V}$	-	-	1.0	μA	
	*6 High level output current (3)	$I_{OH(3)}$		-	-	50	μA	
	High level supply current (1)	$I_{CCH(1)}$	$I_F=0, V_{CC}=15\text{V}, V_O=\text{OPEN}$	-	0.02	1.0	μA	
	*6 High level supply current (2)	$I_{CCH(2)}$		-	-	2.0	μA	
	Low level supply current	I_{CCL}	$I_F=16\text{mA}, V_{CC}=15\text{V}, V_O=\text{OPEN}$	-	120	-	μA	
	Low level output voltage	V_{OL}	$I_F=16\text{mA}, V_{CC}=4.5\text{V}, I_O=2.4\text{mA}$	-	-	0.4	V	
Transfer characteristics	Current transfer ratio (1)	CTR (1)	$I_F=16\text{mA}, V_{CC}=4.5\text{V}, V_O=0.4\text{V}, R_L=1.9\text{k}\Omega$	19	-	50	%	
	*6 Current transfer ratio (2)	CTR (2)		15	-	-	%	
	Isolation resistance	R_{ISO}	DC500V, 40 to 60%RH	5×10^{10}	10^{11}	-	Ω	
	Floating capacitance	C_f	$V=0, f=1\text{MHz}$	-	0.6	1.0	pF	
	Response time	"High \rightarrow Low" propagation delay time	t_{PHL}	$I_F=16\text{mA}, V_{CC}=5\text{V}, R_L=1.9\Omega$	-	0.2	0.8	μs
		"Low \rightarrow High" propagation delay time	t_{PLH}		-	0.4	0.8	μs
	Instantaneous common mode rejection voltage (High level output)		CM_H	$I_F=0, V_{CC}=5\text{V}, V_{CM}=1.0\text{kV}_{(p-p)}, R_L=1.9\text{k}\Omega$	15	30	-	kV/ μs
Instantaneous common mode rejection voltage (Low level output)		CM_L	$I_F=16\text{mA}, V_{CC}=5\text{V}, V_{CM}=1.0\text{kV}_{(p-p)}, R_L=1.9\text{k}\Omega$	-15	-30	-	kV/ μs	

*6 $T_a=0$ to 70 $^{\circ}\text{C}$

*7 It shall connect a by-pass capacitor of 0.01 μF or more between V_{CC} (pin ⑥) and GND (pin ④) near the device, when it measures transfer characteristics and the output side characteristics.

■ **Model Line-up**

Package	Taping	
	3 000pcs/reel	
VDE0884	———	Approved
Model No.	PC457L0NIP	PC457L0YIP

Please contact a local SHARP sales representative to inquire about production status and Lead-Free options.

Fig.1 Test Circuit for Propagation Delay Time

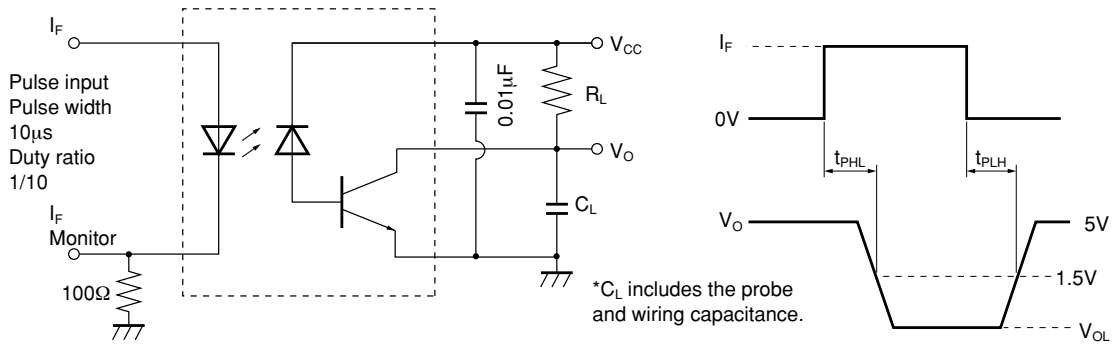

Fig.2 Test Circuit for Instantaneous Common Mode Rejection Voltage

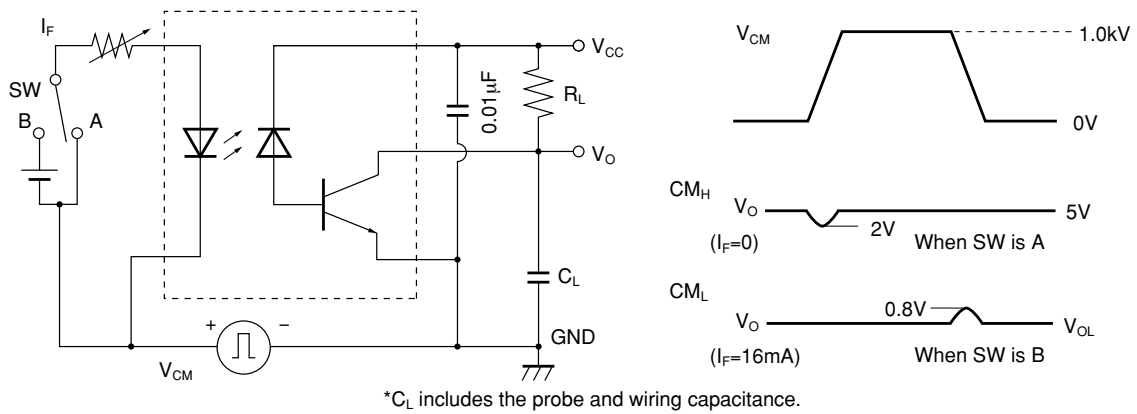

Fig.3 Forward Current vs. Ambient Temperature

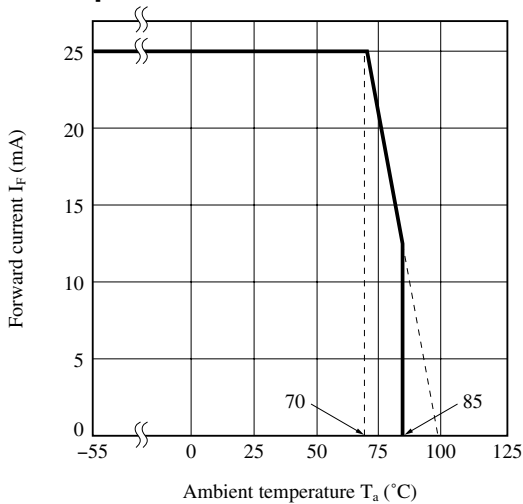

Fig.4 Power Dissipation vs. Ambient Temperature

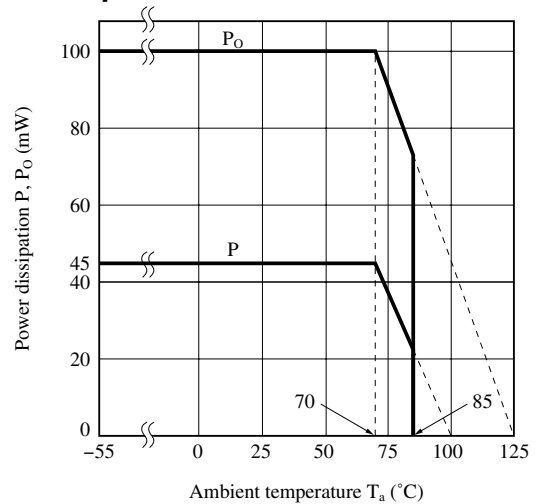

Fig.5 Forward Current vs. Forward Voltage

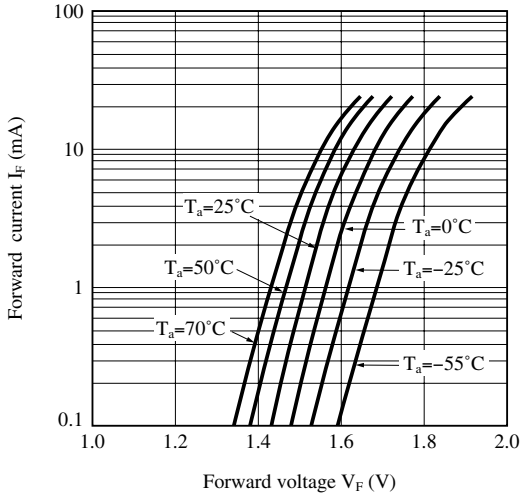

Fig.6 Relative Current Transfer Ratio vs. Forward Current

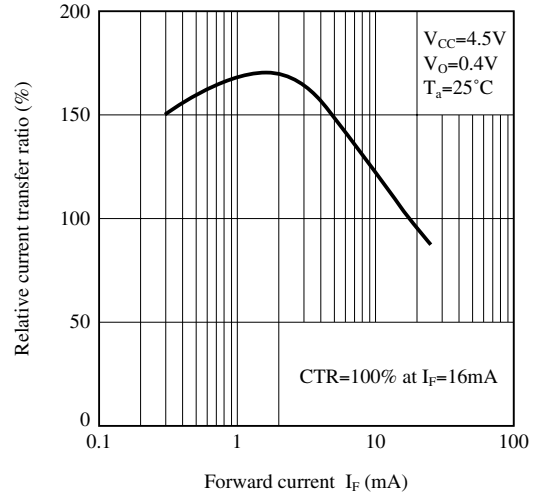

Fig.7 Output Current vs. Output Voltage

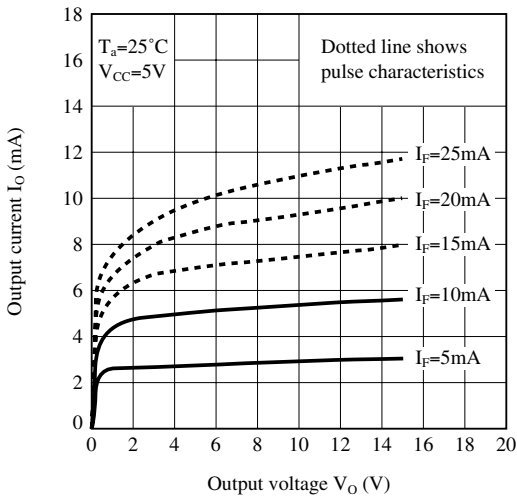

Fig.8 Relative Current Transfer Ratio vs. Ambient Temperature

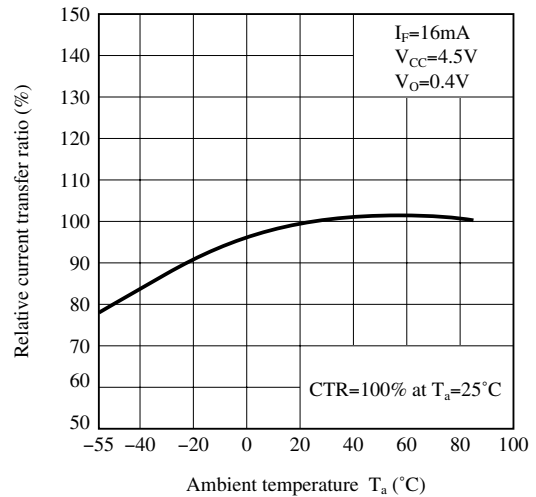

Fig.9 High Level Output Current vs. Ambient Temperature

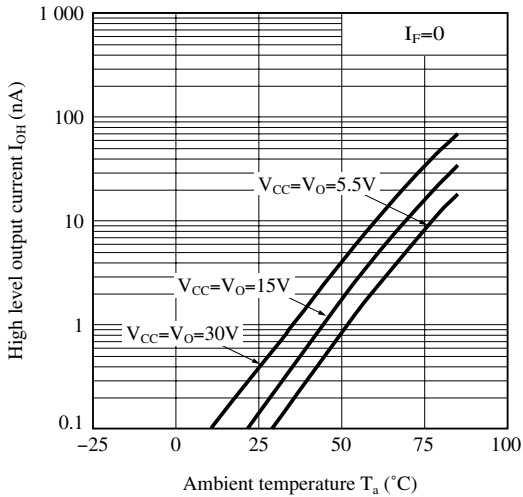
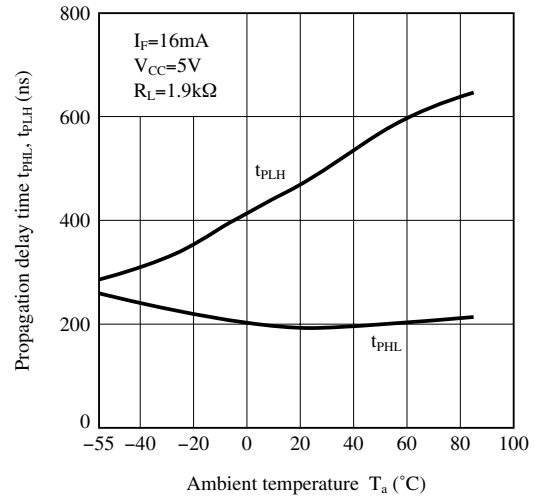

Fig.10 Propagation Delay Time vs. Ambient Temperature



Remarks : Please be aware that all data in the graph are just for reference and not for guarantee.

■ Design Considerations

● Recommended operating conditions

Parameter	Symbol	MIN.	TYP.	MAX.	Unit
Input current	I_F	7	-	16	mA
Supply voltage	V_{CC}	-	5	-	V
Fan out (TTL load)	N	-	-	5	-
Operating temperature	T_{opr}	0	-	+70	°C

● Notes about static electricity

Transistor of detector side in bipolar configuration may be damaged by static electricity due to its minute design.

When handling these devices, general countermeasure against static electricity should be taken to avoid breakdown of devices or degradation of characteristics.

● Design guide

In order to stabilize power supply line, we should certainly recommend to connect a by-pass capacitor of 0.01 μ F or more between V_{CC} and GND near the device.

In case that some sudden big noise caused by voltage variation is provided between primary and secondary terminals of photocoupler some current caused by it is floating capacitance may be generated and result in false operation since current may go through LED or current may change.

If the photocoupler may be used under the circumstances where noise will be generated we recommend to use the bypass capacitors at the both ends of LED.

The detector which is used in this device, has parasitic diode between each pins and GND.

There are cases that miss operation or destruction possibly may be occurred if electric potential of any pin becomes below GND level even for instant.

Therefore it shall be recommended to design the circuit that electric potential of any pin does not become below GND level.

This product is not designed against irradiation and incorporates non-coherent LED.

● Degradation

In general, the emission of the LED used in photocouplers will degrade over time.

In the case of long term operation, please take the general LED degradation (50% degradation over 5years) into the design consideration.

● Recommended Foot Print (reference)

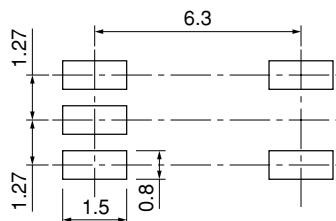

(Unit : mm)

☆ For additional design assistance, please review our corresponding Optoelectronic Application Notes.

■ Manufacturing Guidelines

● Soldering Method

Reflow Soldering:

Reflow soldering should follow the temperature profile shown below.

Soldering should not exceed the curve of temperature profile and time.

Please don't solder more than twice.

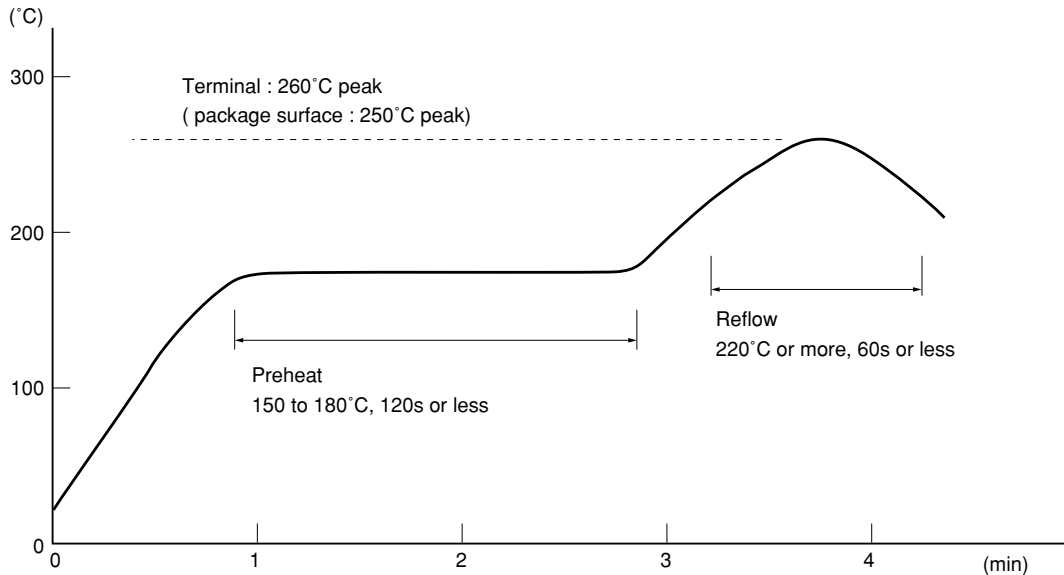

Flow Soldering :

Due to SHARP's double transfer mold construction submersion in flow solder bath is allowed under the below listed guidelines.

Flow soldering should be completed below 260°C and within 10s.

Preheating is within the bounds of 100 to 150°C and 30 to 80s.

Please don't solder more than twice.

Hand soldering

Hand soldering should be completed within 3s when the point of solder iron is below 400°C.

Please don't solder more than twice.

Other notices

Please test the soldering method in actual condition and make sure the soldering works fine, since the impact on the junction between the device and PCB varies depending on the tooling and soldering conditions.

● Cleaning instructions**Solvent cleaning:**

Solvent temperature should be 45°C or below Immersion time should be 3minutes or less

Ultrasonic cleaning:

The impact on the device varies depending on the size of the cleaning bath, ultrasonic output, cleaning time, size of PCB and mounting method of the device.

Therefore, please make sure the device withstands the ultrasonic cleaning in actual conditions in advance of mass production.

Recommended solvent materials:

Ethyl alcohol, Methyl alcohol and Isopropyl alcohol

In case the other type of solvent materials are intended to be used, please make sure they work fine in actual using conditions since some materials may erode the packaging resin.

● Presence of ODC

This product shall not contain the following materials.

And they are not used in the production process for this device.

Regulation substances : CFCs, Halon, Carbon tetrachloride, 1.1.1-Trichloroethane (Methylchloroform)

Specific brominated flame retardants such as the PBBOs and PBBs are not used in this product at all.

■ Package specification

● Tape and Reel package

Package materials

Carrier tape : A-PET (with anti-static material)

Cover tape : PET (three layer system)

Reel : PS

Carrier tape structure and Dimensions

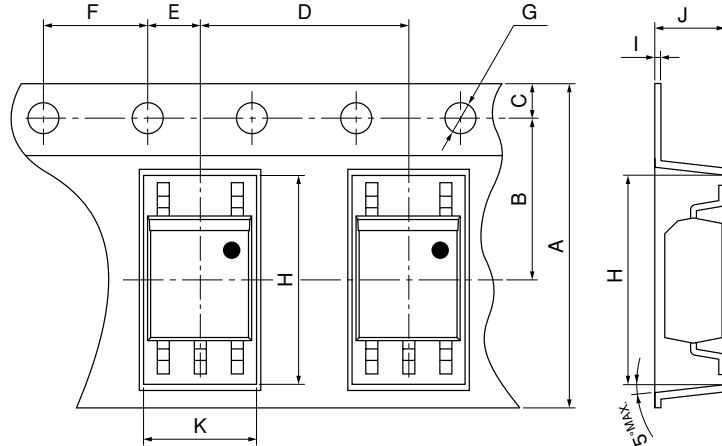

Dimensions List (Unit : mm)

A	B	C	D	E	F	G
12.0±0.3	5.5±0.1	1.75±0.1	8.0±0.1	2.0±0.1	4.0±0.1	φ1.5±0.1
H	I	J	K			
7.4±0.1	0.3±0.05	3.1±0.1	4.0±0.1			

Reel structure and Dimensions

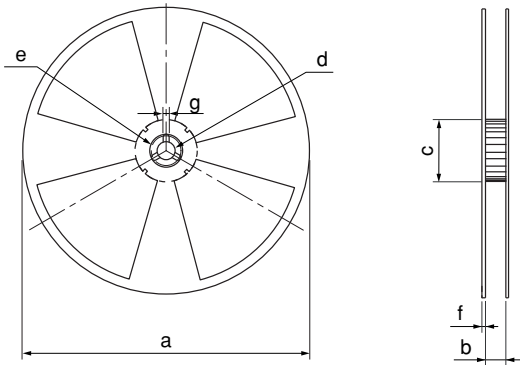

Dimensions List (Unit : mm)

a	b	c	d
370	13.5±1.5	80±1.0	13±0.5
e	f	g	
21±1.0	2.0±0.5	2.0±0.5	

Direction of product insertion

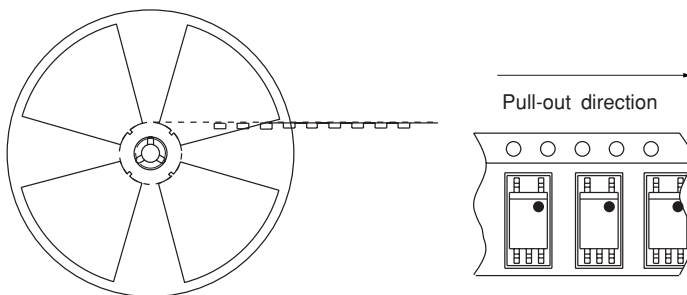

[Packing : 3 000pcs/reel]

■ Important Notices

· The circuit application examples in this publication are provided to explain representative applications of SHARP devices and are not intended to guarantee any circuit design or license any intellectual property rights. SHARP takes no responsibility for any problems related to any intellectual property right of a third party resulting from the use of SHARP's devices.

· Contact SHARP in order to obtain the latest device specification sheets before using any SHARP device. SHARP reserves the right to make changes in the specifications, characteristics, data, materials, structure, and other contents described herein at any time without notice in order to improve design or reliability. Manufacturing locations are also subject to change without notice.

· Observe the following points when using any devices in this publication. SHARP takes no responsibility for damage caused by improper use of the devices which does not meet the conditions and absolute maximum ratings to be used specified in the relevant specification sheet nor meet the following conditions:

(i) The devices in this publication are designed for use in general electronic equipment designs such as:

- Personal computers
- Office automation equipment
- Telecommunication equipment [terminal]
- Test and measurement equipment
- Industrial control
- Audio visual equipment
- Consumer electronics

(ii) Measures such as fail-safe function and redundant design should be taken to ensure reliability and safety when SHARP devices are used for or in connection

with equipment that requires higher reliability such as:

- Transportation control and safety equipment (i.e., aircraft, trains, automobiles, etc.)
- Traffic signals
- Gas leakage sensor breakers
- Alarm equipment
- Various safety devices, etc.

(iii) SHARP devices shall not be used for or in connection with equipment that requires an extremely high level of reliability and safety such as:

- Space applications
- Telecommunication equipment [trunk lines]
- Nuclear power control equipment
- Medical and other life support equipment (e.g., scuba).

· If the SHARP devices listed in this publication fall within the scope of strategic products described in the Foreign Exchange and Foreign Trade Law of Japan, it is necessary to obtain approval to export such SHARP devices.

· This publication is the proprietary product of SHARP and is copyrighted, with all rights reserved. Under the copyright laws, no part of this publication may be reproduced or transmitted in any form or by any means, electronic or mechanical, for any purpose, in whole or in part, without the express written permission of SHARP. Express written permission is also required before any use of this publication may be made by a third party.

· Contact and consult with a SHARP representative if there are any questions about the contents of this publication.