

Excellent Integrated System Limited

Stocking Distributor

Click to view price, real time Inventory, Delivery & Lifecycle Information:

[Bourns Inc.](#)
[TISPL758LF3DR-S](#)

For any questions, you can email us directly:
sales@integrated-circuit.com



TISPL758LF3D

INTEGRATED SYMMETRICAL AND ASYMMETRICAL BIDIRECTIONAL OVERVOLTAGE PROTECTORS FOR LUCENT TECHNOLOGIES L7581/2/3 LINE CARD ACCESS SWITCHES

TISPL758LF3D LCAS Protector

Symmetrical and Asymmetrical Characteristics for Optimum Protection of Lucent L7581/2/3 LCAS

Terminal Pair	V _{DRM} V	V _(BO) V
T-G (SYMMETRICAL)	±105	±130
R-G (ASYMMETRICAL)	+105, -180	+130, -220

Customized versions available

D Package (Top View)

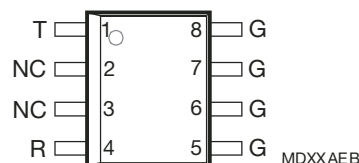

NC - No internal connection

Rated for International Surge Wave Shapes

Wave Shape	Standard	I _{TSP} A
2/10 μs	GR-1089-CORE	175
8/20 μs	ANSI C62.41	120
10/160 μs	FCC Part 68	60
10/700 μs	ITU-T K20/21	50
10/560 μs	FCC Part 68	45
10/1000 μs	GR-1089-CORE	35

Device Symbol

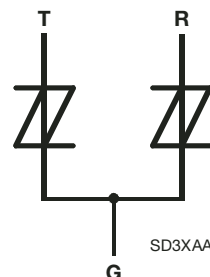

Terminals T, R and G correspond to the alternative line designators of A, B and C

Ion-Implanted Breakdown Region

- Precise And Stable Voltage
- Low Voltage Overshoot Under Surge

Planar Passivated Junctions

- Low Off-State Current.....< ±10 μA



.....UL Recognized Component

How to Order

Device	Carrier	Order As
TISPL758LF3D	Tube	TISPL758LF3D-S
	Taped and reeled	TISPL758LF3DR-S

Description

The TISPL758LF3 is an integrated combination of a symmetrical bidirectional overvoltage protector and an asymmetrical bidirectional overvoltage protector. It is designed to limit the peak voltages on the line terminals of the Lucent Technologies L7581/2/3 LCAS (Line Card Access Switches). An LCAS may also be referred to as a Solid State Relay, SSR, i.e. a replacement of the conventional electro-mechanical relay.

The TISPL758LF3D voltages are chosen to give adequate LCAS protection for all switch conditions. The most potentially stressful condition is low level power cross when the LCAS switches are closed. Under this condition, the TISPL758LF3D limits the voltage and corresponding LCAS dissipation until the LCAS thermal trip operates and opens the switches.

Under open-circuit ringing conditions, the line ring (R) conductor will have high peak voltages. For battery backed ringing, the ring conductor will have a larger peak negative voltage than positive i.e. the peak voltages are asymmetric. An overvoltage protector with a similar voltage asymmetry will give the most effective protection. On a connected line, the tip (T) conductor will have much smaller voltage levels than the open-circuit ring conductor values. Here a symmetrical voltage protector gives adequate protection.

TISPL758LF3D LCAS Protector



Description (Continued)

Overvoltages are normally caused by a.c. power system or lightning flash disturbances which are induced or conducted on to the telephone line. These overvoltages are initially clipped by protector breakdown clamping until the voltage rises to the breakover level, which causes the device to crowbar into a low-voltage on state. This low-voltage on state causes the current resulting from the overvoltage to be safely diverted through the device. For negative surges, the high crowbar holding current helps prevent d.c. latching with the SLIC current, as the surge current subsides. The TISPL758LF3 is guaranteed to voltage limit and withstand the listed international lightning surges in both polarities.

Support from the Microelectronics Group of Lucent Technologies Inc. is gratefully acknowledged in the definition of the TISPL758LF3D voltage levels and for performing TISPL758LF3D evaluations.

Absolute Maximum Ratings, $T_A = 25\text{ }^\circ\text{C}$ (Unless Otherwise Noted)

Rating		Symbol	Value	Unit
Repetitive peak off-state voltage	R-G terminals T-G terminals	V_{DRM}	-180, +105 -105, +105	V
Non-repetitive peak on-state pulse current (see Notes 1, 2 and 3)				
2/10 μs (GR-1089-CORE, 2/10 μs voltage wave shape)			175	
8/20 μs (ANSI C62.41, 1.2/50 μs voltage wave shape)			120	
10/160 μs (FCC Part 68, 10/160 μs voltage wave shape)			60	
5/200 μs (VDE 0433, 2.0 kV, 10/700 μs voltage wave shape)			50	
0.2/310 μs (I3124, 2.0 kV, 0.5/700 μs voltage wave shape)			50	
5/310 μs (ITU-T K20/21, 2.0 kV, 10/700 μs voltage wave shape)			50	
5/310 μs (FTZ R12, 2.0 kV, 10/700 μs voltage wave shape)			50	
10/560 μs (FCC Part 68, 10/560 μs voltage wave shape)			45	
10/1000 μs (GR-1089-CORE, 10/1000 μs voltage wave shape)			35	
Non-repetitive peak on-state current (see Notes 1, 2 and 3)				
full sine wave	50 Hz 60 Hz	I_{TSM}	16 20	A
Repetitive peak on-state current, 50/60 Hz, (see Notes 2 and 3)		I_{TSM}	2x1	A
Initial rate of rise of on-state current, Exponential current ramp, Maximum ramp value < 70 A		di_T/dt	150	A/ μs
Junction temperature		T_J	-40 to +150	$^\circ\text{C}$
Storage temperature range		T_{stg}	-40 to +150	$^\circ\text{C}$

- NOTES: 1. Above the maximum specified temperature, derate linearly to zero at 150 $^\circ\text{C}$ lead temperature.
 2. Initially the TISPL758LF3 must be in thermal equilibrium with 0 $^\circ\text{C}$ < T_J < 70 $^\circ\text{C}$.
 3. The surge may be repeated after the TISPL758LF3 returns to its initial conditions.

Recommended Operating Conditions

Component	Min	Typ	Max	Unit
R1 Series Resistor for GR-1089-CORE	20			Ω
Series Resistor for FCC Part 68	0			
R1 10/160 non-operational pass	18			Ω
10/160 operational pass	0			
R1 10/560 non-operational pass	10			Ω
10/560 operational pass	0			
R1 Series Resistor for ITU-T K20/21	0			Ω
10/700, < 2 kV, operational pass	40			
10/700, 4 kV, operational pass				

TISPL758LF3D LCAS Protector



Electrical Characteristics for the T-G and R-G Terminal Pairs, $T_J = 25\text{ }^\circ\text{C}$ (Unless Otherwise Noted)

Parameter	Test Conditions	Value			Unit
		Min	Typ	Max	
I_{DRM} Repetitive peak off-state current	$V_D = \pm V_{DRM}$, (See Note 4)			± 10	μA
$V_{(BO)}$ Breakover voltage	$dv/dt = \pm 250\text{ V/ms}$, $R_{SOURCE} = 300\ \Omega$	R-G terminals -220 T-G terminals -130		+130 +130	V
$V_{(BO)}$ Impulse breakover voltage	Rated impulse conditions with operational pass series resistor	R-G terminals -240 T-G terminals -140		+140 +140	V
I_H Holding current	$di/dt = -30\text{ mA/ms}$ $di/dt = +30\text{ mA/ms}$	+100 -150			mA
I_D Off-state current	$0 < V_D < \pm 50\text{ V}$, $T_J = 85\text{ }^\circ\text{C}$			± 10	μA
C_{TG} Off-state capacitance	$f = 100\text{ kHz}$, $V_d = 1\text{ V rms}$ $V_{TG} = -5\text{ V}$, (See Note 5)		18	36	pF
C_{RG} Off-state capacitance	$f = 100\text{ kHz}$, $V_d = 1\text{ V rms}$ $V_{TG} = -50\text{ V}$, (See Note 5)		10	20	pF

NOTES: 4. Positive and negative values of V_{DRM} are not equal. See ratings table.

5. These capacitance measurements employ a three terminal capacitance bridge incorporating a guard circuit. The third terminal is connected to the guard terminal of the bridge.

Thermal Characteristics

Parameter	Test Conditions	Min	Typ	Max	Unit
$R_{\theta JA}$ Junction to free air thermal resistance				160	$^\circ\text{C/W}$

TISPL758LF3D LCAS Protector **BOURNS®**

Parameter Measurement Information

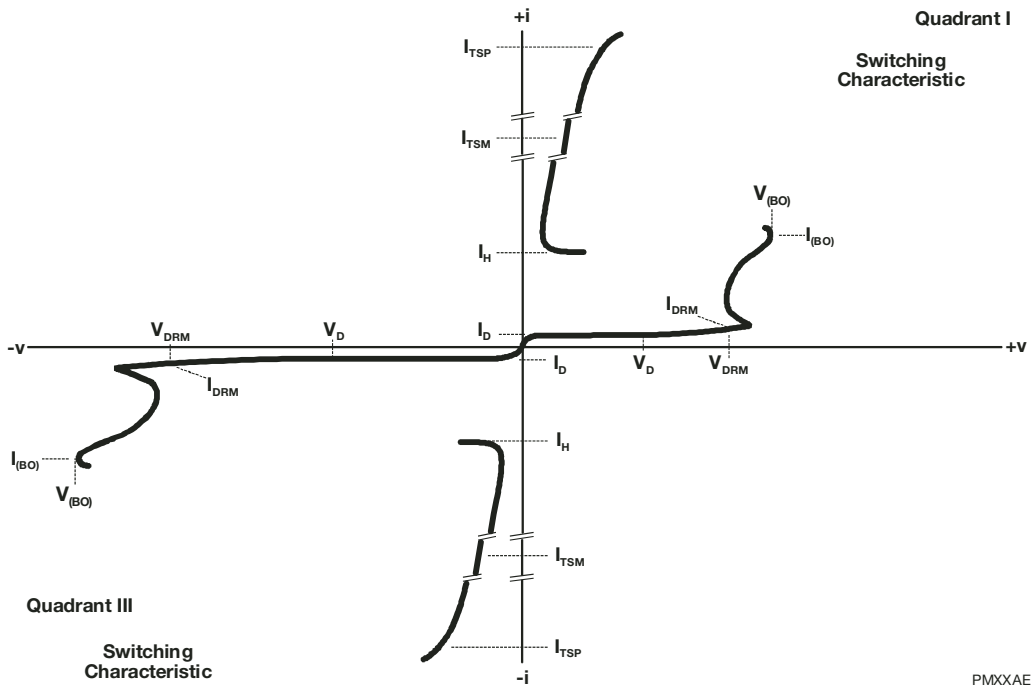

Figure 1. Asymmetrical Voltage-Current Characteristic for R-G Terminal Pair

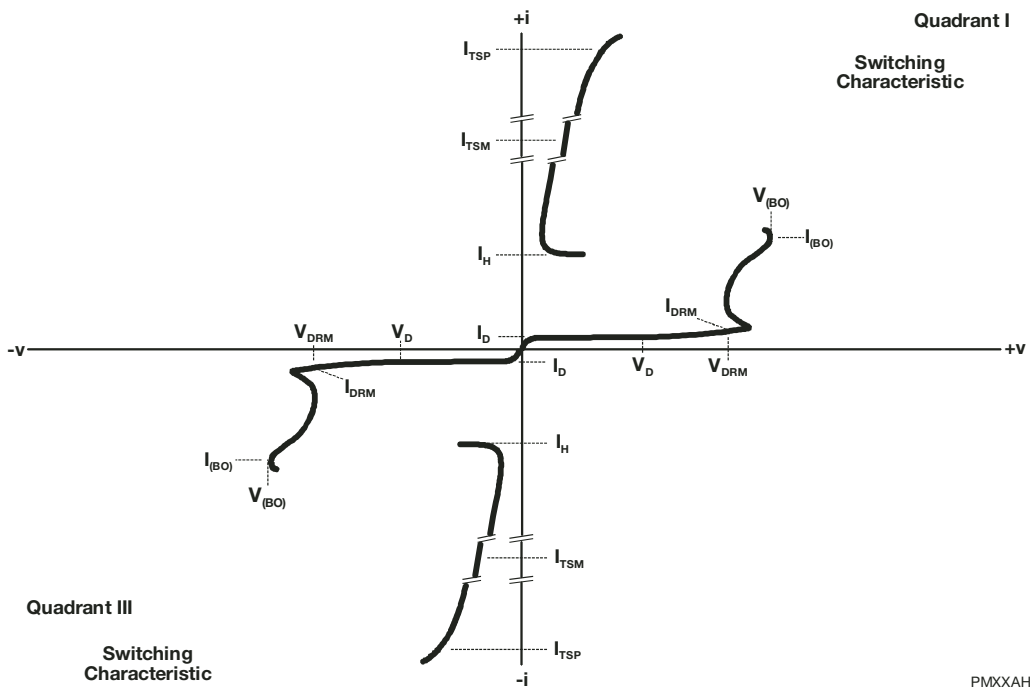

Figure 2. Symmetrical Voltage-current Characteristic for T-G Terminal Pair

TISPL758LF3D LCAS Protector



Typical Characteristics

**OFF-STATE CURRENT
vs
JUNCTION TEMPERATURE**

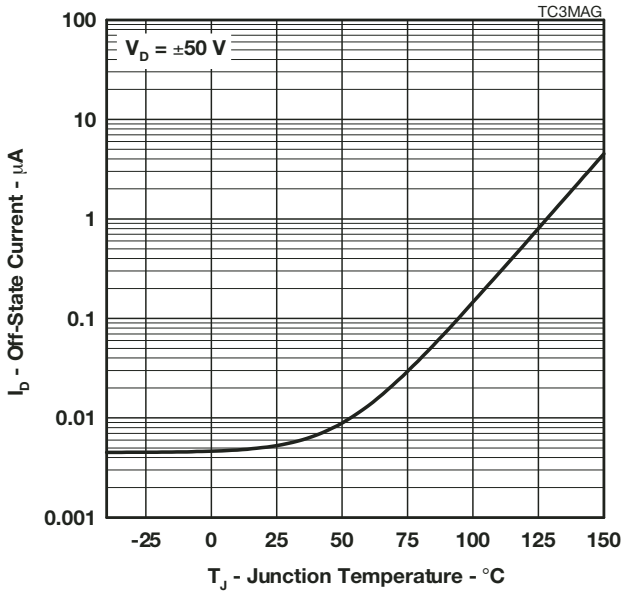

Figure 3.

**NORMALIZED BREAKDOWN VOLTAGES
vs
JUNCTION TEMPERATURE**

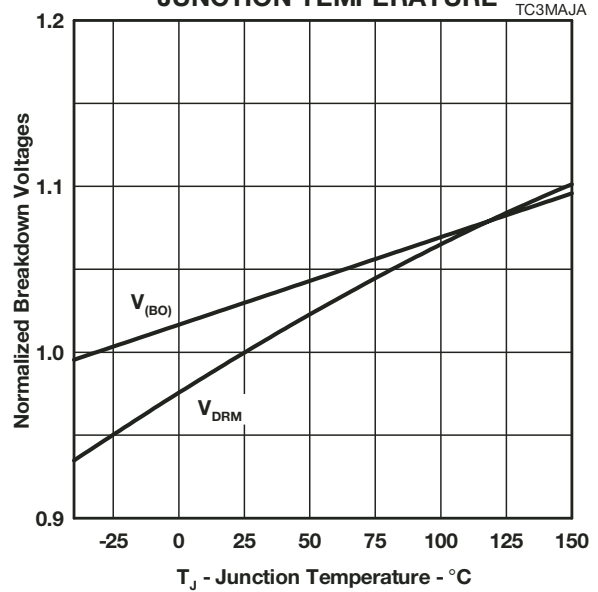

Figure 4.

**NORMALIZED BREAKOVER VOLTAGE
vs
RATE OF RISE OF PRINCIPLE CURRENT**

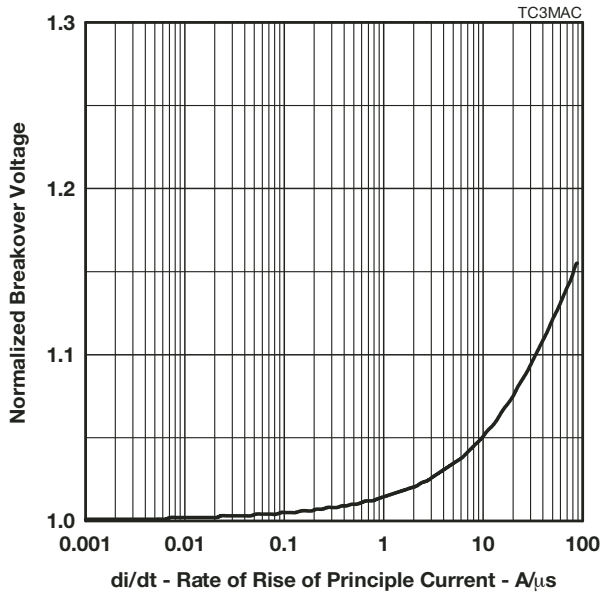

Figure 5.

**NORMALIZED HOLDING CURRENT
vs
JUNCTION TEMPERATURE**

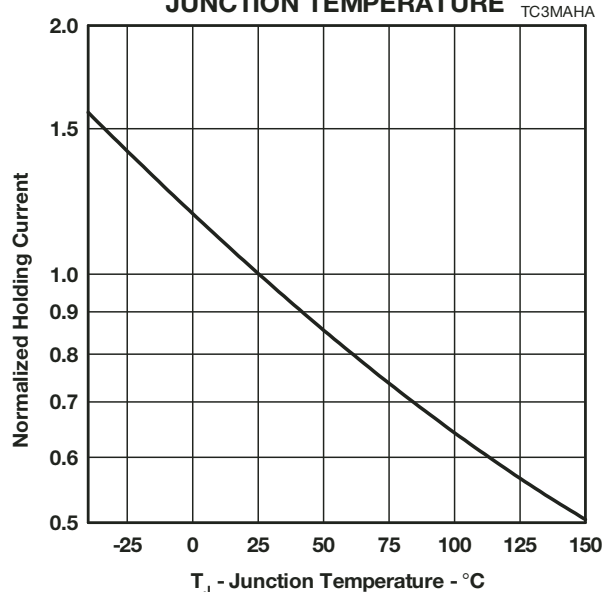

Figure 6.

TISPL758LF3D LCAS Protector **BOURNS®**

Applications Information

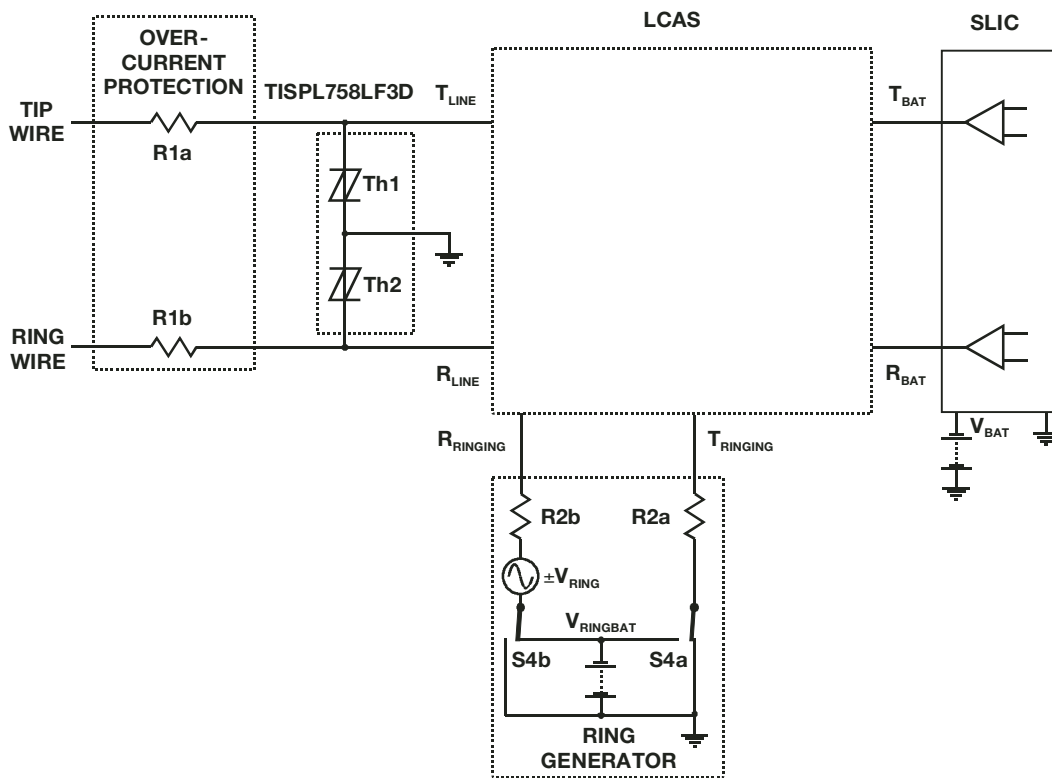

Figure 7. LCAS Protection with a TISPL758LF3D

Bourns Sales Offices

Region	Phone	Fax
The Americas:	+1-951-781-5500	+1-951-781-5700
Europe:	+41-41-7685555	+41-41-7685510
Asia-Pacific:	+886-2-25624117	+886-2-25624116

Technical Assistance

Region	Phone	Fax
The Americas:	+1-951-781-5500	+1-951-781-5700
Europe:	+41-41-7685555	+41-41-7685510
Asia-Pacific:	+886-2-25624117	+886-2-25624116

www.bourns.com

Bourns® products are available through an extensive network of manufacturer's representatives, agents and distributors. To obtain technical applications assistance, a quotation, or to place an order, contact a Bourns representative in your area.



Reliable Electronic Solutions