

Rx Coil Units

WR444030-16F3-G

■ SHAPE & DIMENSIONS

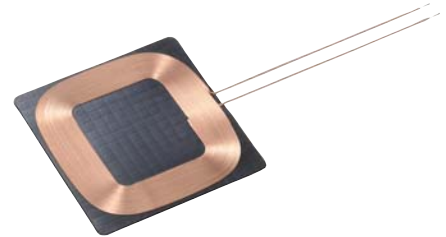
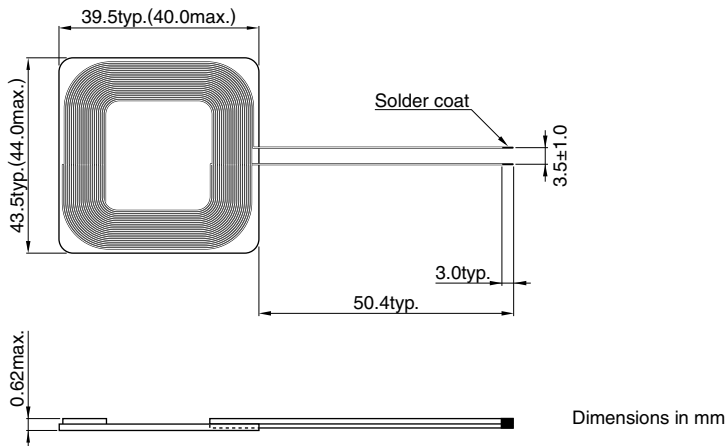

■ ELECTRICAL CHARACTERISTICS

□ CHARACTERISTICS SPECIFICATION TABLE

LxW Dimensions (mm)	Thickness (mm)max.	Efficiency* (%)ref.	Inductance (μH) [100kHz, 1Vrms]	DC resistance (Ω)max. [25°C]	Part No.
43.5x39.5	0.62	70	19.0	0.70	WR444030-16F3-G

* Contact us for more information.