

❖ THI

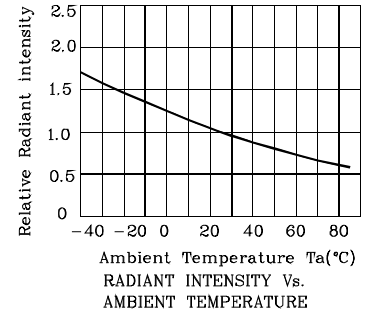

Wave Soldering Profile For Thru-Hole Products (Pb-Free Components)

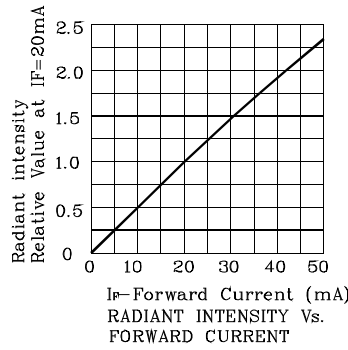

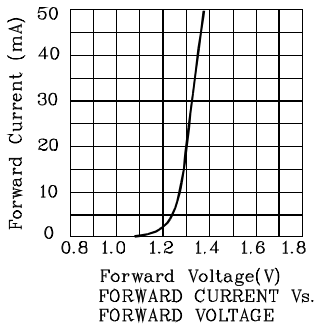
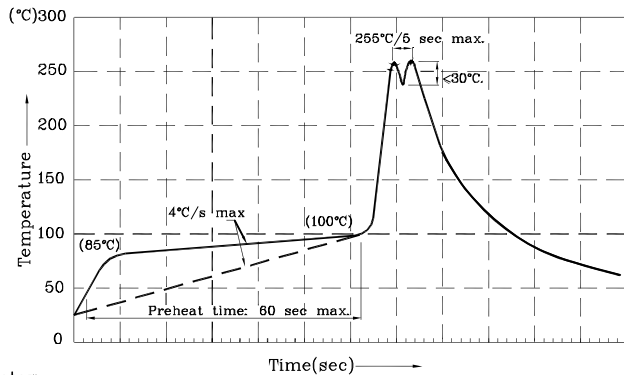

- Notes:
1. Recommend pre-heat temperature of 105°C or less (as measured with a thermocouple attached to the LED pins) prior to immersion in the solder wave with a maximum solder bath temperature of 280°C
  2. Peak wave soldering temperature between 245°C ~ 255°C for 3 sec (5 sec max).
  3. Do not apply stress to the epoxy resin while the temperature is above 85°C.
  4. Fixtures should not incur stress on the component when mounting and during soldering process.
  5. SAC 305 solder alloy is recommended.
  6. No more than one wave soldering pass.

Remarks:

- If special sorting is required (e.g. binning based on forward voltage, luminous intensity / luminous flux), the typical accuracy of the sorting process is as follows:
1. Radiant Intensity / Luminous Flux: +/-15%
  2. Forward Voltage: +/-0.1V
- Note: Accuracy may depend on the sorting parameters.

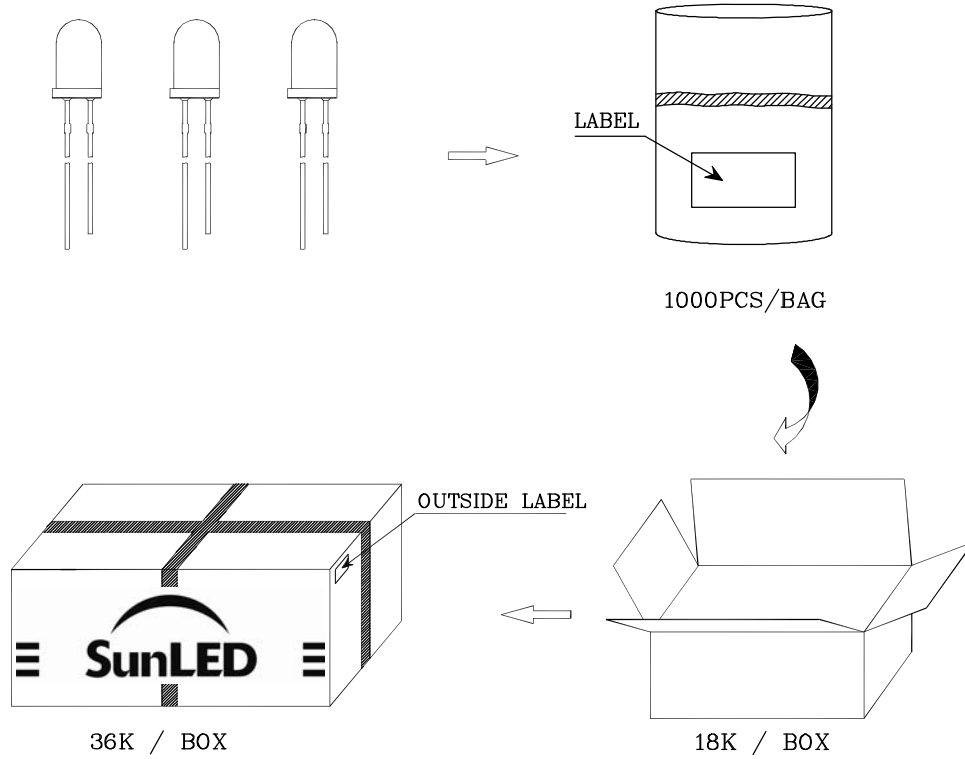
**PACKING & LABEL SPECIFICATIONS**



		<table border="1"> <tr><td>Q.C.</td></tr> <tr><td>QC</td></tr> <tr><td>XX XX XXXX</td></tr> <tr><td>PASSED</td></tr> </table>	Q.C.	QC	XX XX XXXX	PASSED
Q.C.						
QC						
XX XX XXXX						
PASSED						
P/NO : XTxx12x						
QTY : 1000 pcs		CODE: XXX				
S/N : XX						
LOT NO:						
 XXXXXXXXXXXXXXXXXXXXXXXX						
RoHS Compliant						

**TERMS OF USE**

1. Data presented in this document reflect statistical figures and should be treated as technical reference only.
2. Contents within this document are subject to improvement and enhancement changes without notice.
3. The product(s) in this document are designed to be operated within the electrical and environmental specifications indicated on the datasheet. User accepts full risk and responsibility when operating the product(s) beyond their intended specifications.
4. The product(s) described in this document are intended for electronic applications in which a person's life is not reliant upon the LED. Please consult with a SunLED representative for special applications where the LED may have a direct impact on a person's life.
5. The contents within this document may not be altered without prior consent by SunLED.
6. Additional technical notes are available at <http://www.SunLEDusa.com/TechnicalNotes.asp>