

Excellent Integrated System Limited

Stocking Distributor

Click to view price, real time Inventory, Delivery & Lifecycle Information:

[STMicroelectronics](#)

[STTH1008DTI](#)

For any questions, you can email us directly:

sales@integrated-circuit.com



STTH1008DTI

800 V tandem hyperfast diode

Datasheet – production data

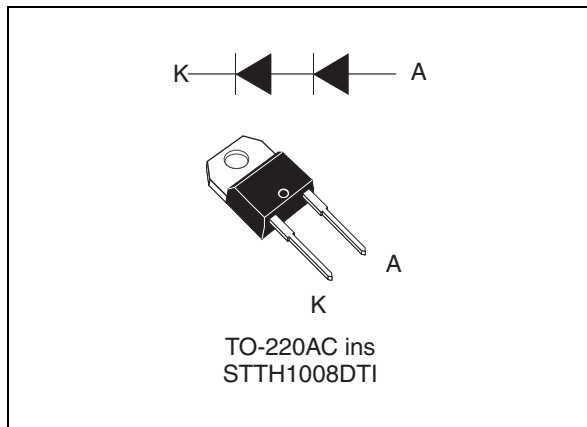

Features

- High voltage rectifier
- Tandem diodes in series
- Very low switching losses
- Insulated device with internal ceramic
- Equal thermal conditions for both 400 V diodes
- Static and dynamic equilibrium of internal diodes are warranted by design

Description

The STTH1008DTI is an ultrahigh performance diode composed of two 400 V dice in series.

Table 1. Device summary

$I_{F(AV)}$	10 A
I_{FRM}	20 A
V_{RRM}	800 V
t_{rr}	40 ns
I_{RM}	8.5 A
V_F	1.7 V
T_j	150 °C

Characteristics

STTH1008DTI

1 Characteristics

Table 2. Absolute ratings (limiting values per diode at 25 °C, unless otherwise specified)

Symbol	Parameter		Value	Unit
V _{RRM}	Repetitive peak reverse voltage		800	V
I _{F(RMS)}	Forward rms current		16	A
I _{F(AV)}	Average forward current, δ = 0.5	T _c = 85 °C	10	A
I _{FRM}	Repetitive peak forward current	T _c = 135 °C, δ = 0.3	20	A
I _{FSM}	Surge non repetitive forward current	t _p = 10 ms sinusoidal	120	A
T _{stg}	Storage temperature range		-65 to +175	°C
T _j	Maximum junction temperature		150	°C

Table 3. Thermal resistance

Symbol	Parameter	Value	Unit
R _{th(j-c)}	Junction to case	2.5	°C/W

Table 4. Static electrical characteristics

Symbol	Parameters	Test conditions		Min.	Typ	Max.	Unit
I _R ⁽¹⁾	Reverse leakage current	T _j = 25 °C	V _R = V _{RRM}			20	μA
		T _j = 150 °C			20	200	
V _F ⁽²⁾	Forward voltage drop	T _c = 25 °C	I _F = 10 A		2.15	2.5	V
		T _c = 150 °C			1.7	2.05	
		T _c = 25 °C	I _F = 20 A		2.45	2.85	
		T _c = 150 °C			2.05	2.45	

1. Pulse test: t_p = 5 ms, δ < 2%
2. Pulse test: t_p = 380 μs, δ < 2%

To evaluate the conduction losses use the following equation:

$$P = 1.65 \times I_{F(AV)} + 0.04 \times I_{F(RMS)}^2$$

STTH1008DTI

Characteristics

Table 5. Dynamic electrical characteristics

Symbol	Parameters	Test conditions		Min.	Typ	Max.	Unit
I_{RM}	Reverse recovery current	$T_j = 125\text{ }^\circ\text{C}$	$I_F = 10\text{ A}, V_R = 400\text{ V},$ $di_F/dt = -200\text{ A}/\mu\text{s}$		8.5	11.5	A
S_{factor}	Softness factor				0.8		
t_{rr}	Reverse recovery time	$T_j = 25\text{ }^\circ\text{C}$	$I_F = 1\text{ A}, V_R = 30\text{ V},$ $di_F/dt = -50\text{ A}/\mu\text{s}$		40	55	ns
		$T_j = 125\text{ }^\circ\text{C}$	$I_F = 10\text{ A}, V_R = 400\text{ V},$ $di_F/dt = -200\text{ A}/\mu\text{s}$		80		
t_{fr}	Forward recovery time	$T_j = 25\text{ }^\circ\text{C}$	$I_F = 10\text{ A}, V_{FR} = 3\text{ V},$ $di_F/dt = 100\text{ A}/\mu\text{s}$			180	ns
V_{FP}	Forward recovery voltage	$T_j = 25\text{ }^\circ\text{C}$			4.5	7	V

Figure 1. Conduction losses versus average current

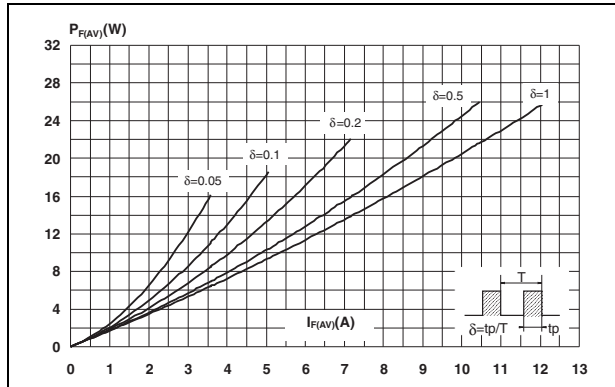

Figure 2. Forward voltage drop versus forward current (typical values)

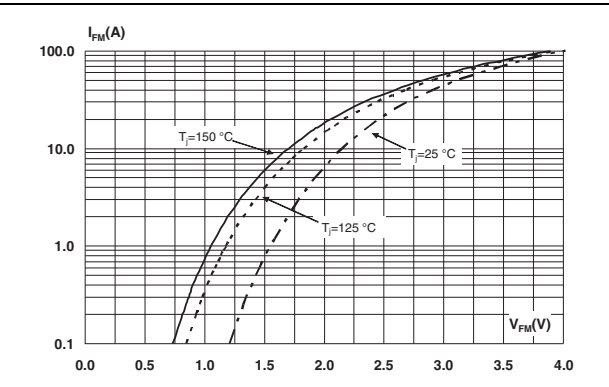

Figure 3. Relative variation of thermal impedance junction to case versus pulse duration

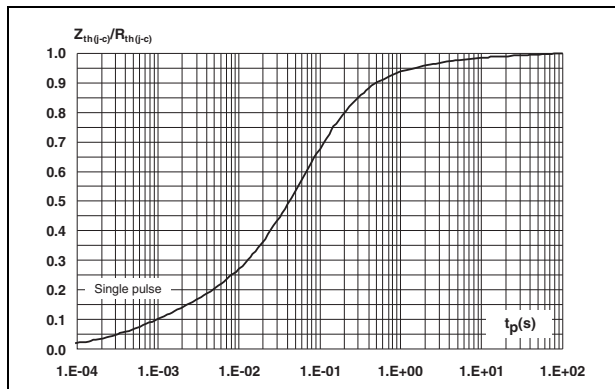
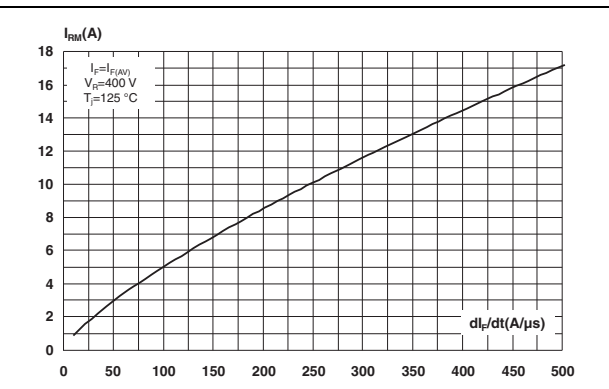

Figure 4. Peak reverse recovery current versus di_F/dt (typical values)



Characteristics

STTH1008DTI

Figure 5. Reverse recovery time versus di_F/dt (typical values)

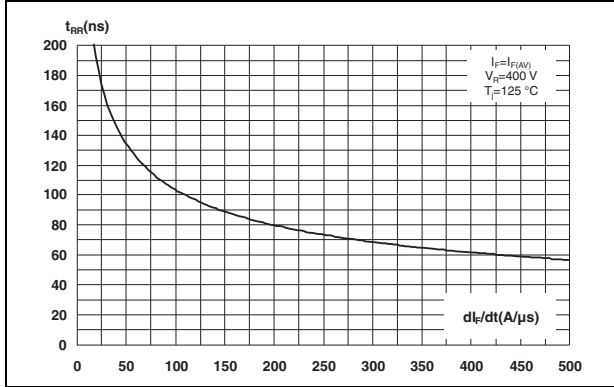

Figure 6. Reverse recovery charges versus di_F/dt (typical values)

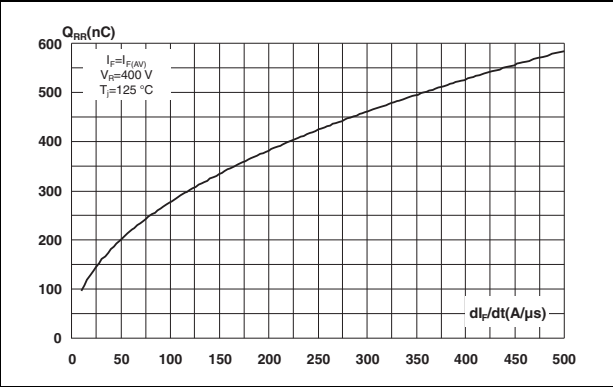

Figure 7. Reverse recovery softness factor versus di_F/dt (typical values)

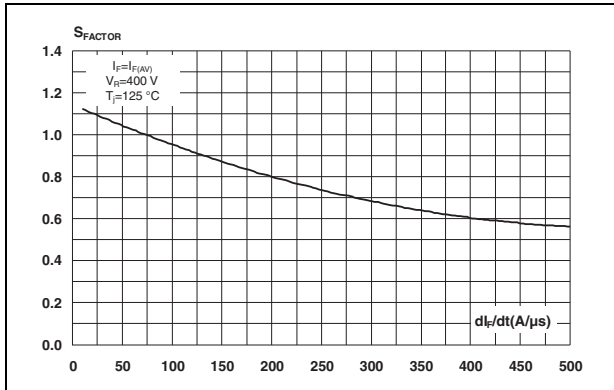

Figure 8. Relative variations of dynamic parameters versus junction temperature

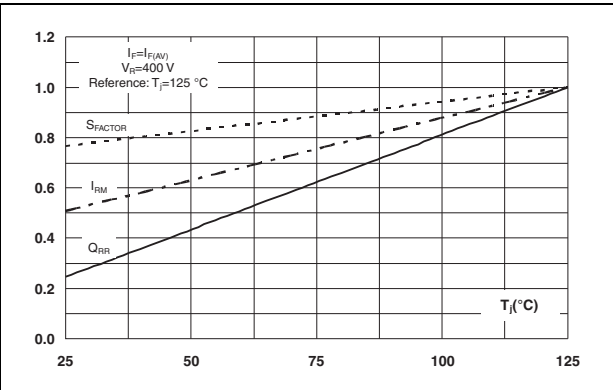

Figure 9. Transient peak forward voltage versus di_F/dt (typical values)

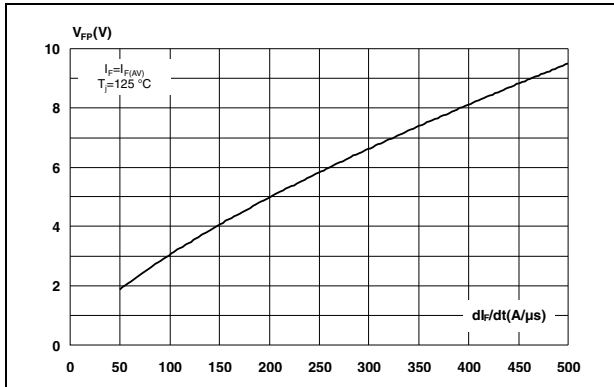
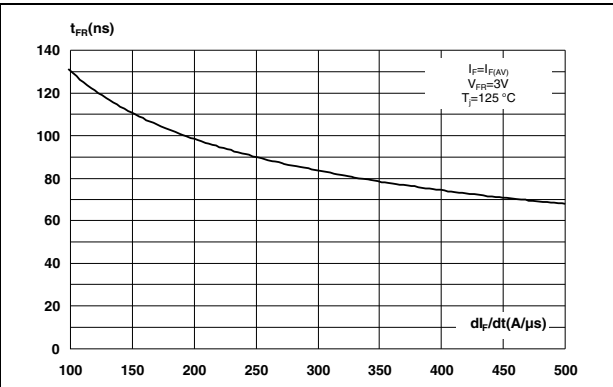

Figure 10. Forward recovery time versus di_F/dt (typical values)



STTH1008DTI

Characteristics

Figure 11. Junction capacitance versus reverse voltage applied (typical values)

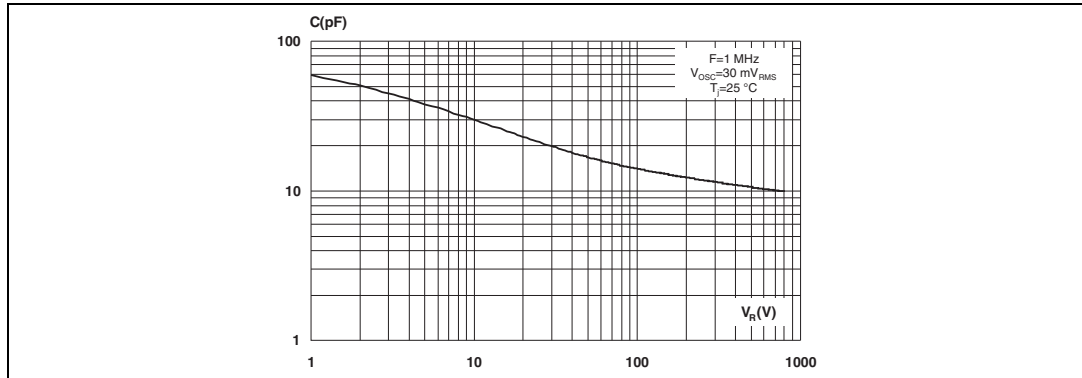

2 Package information

- Epoxy meets UL94, V0
- Cooling method: by conduction (C)
- Recommended torque: 0.4 to 0.6 N·m

In order to meet environmental requirements, ST offers these devices in different grades of ECOPACK® packages, depending on their level of environmental compliance. ECOPACK® specifications, grade definitions and product status are available at: www.st.com. ECOPACK® is an ST trademark.

Figure 12. TO-220AC ins dimension definitions

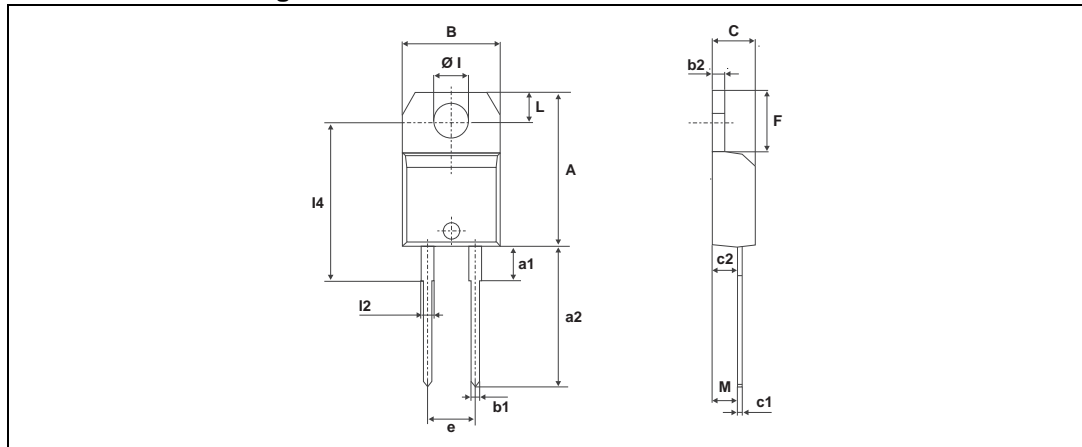

STTH1008DTI

Package information

Table 6. TO-220AC ins dimension values

Ref.	Dimensions					
	Millimeters			Inches		
	Min.	Typ.	Max.	Min.	Typ.	Max.
A	15.20		15.90	0.598		0.625
a1		3.75			0.147	
a2	13.00		14.00	0.511		0.551
B	10.00		10.40	0.393		0.409
b1	0.61		0.88	0.024		0.034
b2	1.23		1.32	0.048		0.051
C	4.40		4.60	0.173		0.181
c1	0.49		0.70	0.019		0.027
c2	2.40		2.72	0.094		0.107
e	4.80		5.40	0.189		0.212
F	6.20		6.60	0.244		0.259
Øl	3.75		3.85	0.147		0.151
l4	15.80	16.40	16.80	0.622	0.646	0.661
L	2.65		2.95	0.104		0.116
l2	1.14		1.70	0.044		0.066
M		2.60			0.102	

3 Ordering information

Table 7. Ordering information

Ordering code	Marking	Package	Weight	Base qty	Delivery mode
STTH1008DTI	STTH1008DTI	TO-220AC insulated	2.3 g	50	Tube

4 Revision history

Table 8. Document revision history

Date	Revision	Changes
05-Mar-2013	1	Initial release.

STTH1008DTI

Please Read Carefully:

Information in this document is provided solely in connection with ST products. STMicroelectronics NV and its subsidiaries ("ST") reserve the right to make changes, corrections, modifications or improvements, to this document, and the products and services described herein at any time, without notice.

All ST products are sold pursuant to ST's terms and conditions of sale.

Purchasers are solely responsible for the choice, selection and use of the ST products and services described herein, and ST assumes no liability whatsoever relating to the choice, selection or use of the ST products and services described herein.

No license, express or implied, by estoppel or otherwise, to any intellectual property rights is granted under this document. If any part of this document refers to any third party products or services it shall not be deemed a license grant by ST for the use of such third party products or services, or any intellectual property contained therein or considered as a warranty covering the use in any manner whatsoever of such third party products or services or any intellectual property contained therein.

UNLESS OTHERWISE SET FORTH IN ST'S TERMS AND CONDITIONS OF SALE ST DISCLAIMS ANY EXPRESS OR IMPLIED WARRANTY WITH RESPECT TO THE USE AND/OR SALE OF ST PRODUCTS INCLUDING WITHOUT LIMITATION IMPLIED WARRANTIES OF MERCHANTABILITY, FITNESS FOR A PARTICULAR PURPOSE (AND THEIR EQUIVALENTS UNDER THE LAWS OF ANY JURISDICTION), OR INFRINGEMENT OF ANY PATENT, COPYRIGHT OR OTHER INTELLECTUAL PROPERTY RIGHT.

ST PRODUCTS ARE NOT AUTHORIZED FOR USE IN WEAPONS. NOR ARE ST PRODUCTS DESIGNED OR AUTHORIZED FOR USE IN: (A) SAFETY CRITICAL APPLICATIONS SUCH AS LIFE SUPPORTING, ACTIVE IMPLANTED DEVICES OR SYSTEMS WITH PRODUCT FUNCTIONAL SAFETY REQUIREMENTS; (B) AERONAUTIC APPLICATIONS; (C) AUTOMOTIVE APPLICATIONS OR ENVIRONMENTS, AND/OR (D) AEROSPACE APPLICATIONS OR ENVIRONMENTS. WHERE ST PRODUCTS ARE NOT DESIGNED FOR SUCH USE, THE PURCHASER SHALL USE PRODUCTS AT PURCHASER'S SOLE RISK, EVEN IF ST HAS BEEN INFORMED IN WRITING OF SUCH USAGE, UNLESS A PRODUCT IS EXPRESSLY DESIGNATED BY ST AS BEING INTENDED FOR "AUTOMOTIVE, AUTOMOTIVE SAFETY OR MEDICAL" INDUSTRY DOMAINS ACCORDING TO ST PRODUCT DESIGN SPECIFICATIONS. PRODUCTS FORMALLY ESCC, QML OR JAN QUALIFIED ARE DEEMED SUITABLE FOR USE IN AEROSPACE BY THE CORRESPONDING GOVERNMENTAL AGENCY.

Resale of ST products with provisions different from the statements and/or technical features set forth in this document shall immediately void any warranty granted by ST for the ST product or service described herein and shall not create or extend in any manner whatsoever, any liability of ST.

ST and the ST logo are trademarks or registered trademarks of ST in various countries.

Information in this document supersedes and replaces all information previously supplied.

The ST logo is a registered trademark of STMicroelectronics. All other names are the property of their respective owners.

© 2013 STMicroelectronics - All rights reserved

STMicroelectronics group of companies

Australia - Belgium - Brazil - Canada - China - Czech Republic - Finland - France - Germany - Hong Kong - India - Israel - Italy - Japan - Malaysia - Malta - Morocco - Philippines - Singapore - Spain - Sweden - Switzerland - United Kingdom - United States of America

www.st.com